

Tratti di Luce

Personalizzabili

Configurabili

Tracciabili

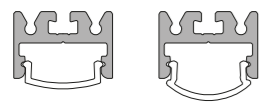

u01
pag. 355

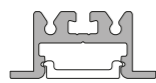

u03
pag. 391



sc015
pag. 313



lc020
pag. 279

NEW

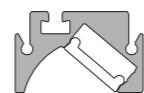

lc014
pag. 287



ch012
pag. 269

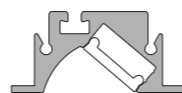

lc021
pag. 303

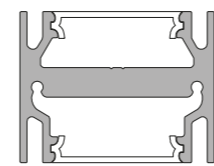

structurae
pag. 225

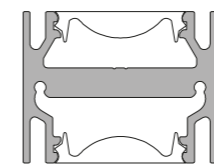

structurae con lente
pag. 231



ms07
pag. 321



ms08
pag. 327



ms09
pag. 335



mf01
pag. 413

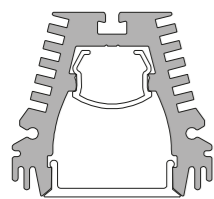

t24
pag. 43

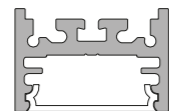

u02 + u02 spot
pag. 371

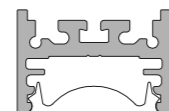

u02 lente
pag. 383

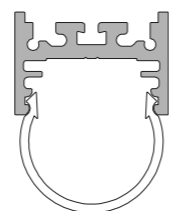

u02 cover tonda
pag. 379

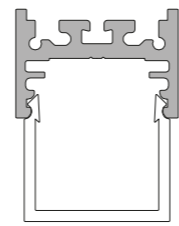

u02 cover quadrata
pag. 379

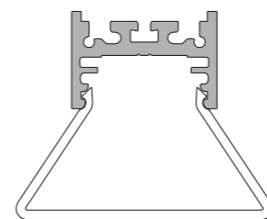

mira
pag. 401

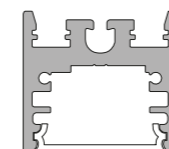

q20 cover opale
pag. 221

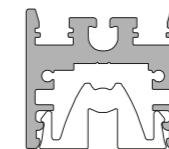

q20 fascio spot
pag. 219

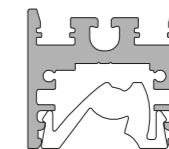

q20 fascio wall washer
pag. 220



mf02
pag. 417



mc01
pag. 407

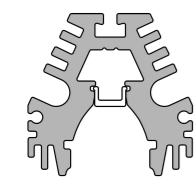

t23
pag. 43

NEW

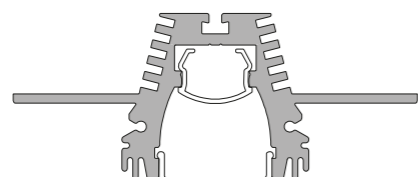

m24
pag. 43

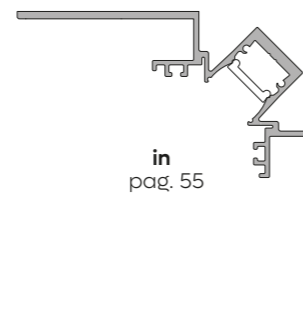

in
pag. 55

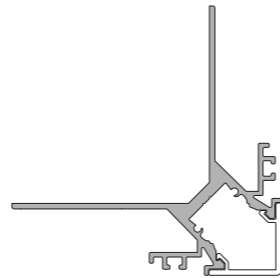

out
pag. 55

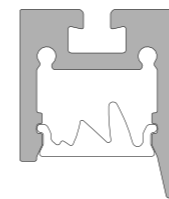

q10
pag. 207

NEW

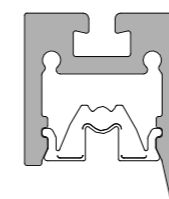

q10 spot
pag. 209

NEW

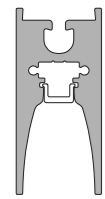

k15
pag. 255

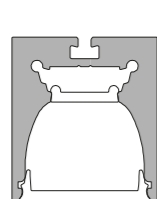

k25
pag. 245

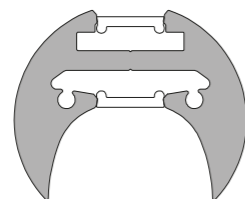

k40
pag. 237

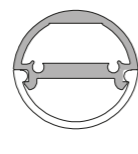

s21
pag. 263

NEW

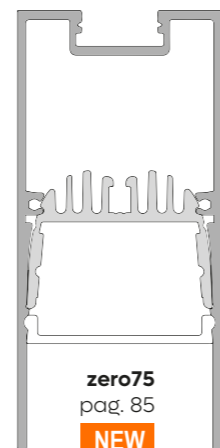

zero75
pag. 85

NEW

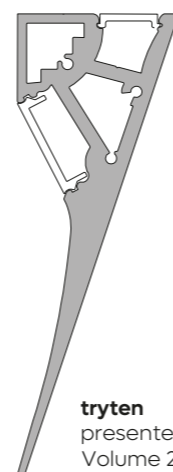

tryten
presente nel
Volume 2.25.1



link/link spot
presente nel
Volume 2.25.1

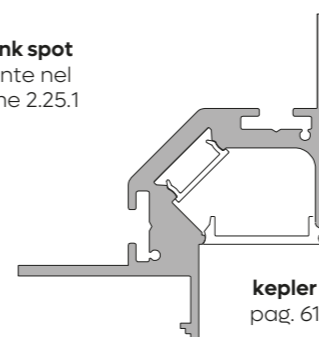

kepler
pag. 61

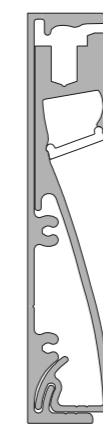

infinito
presente nel Volume 2.25.1

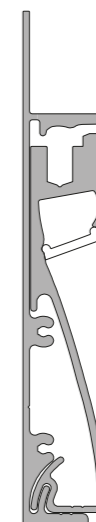

spigolo 23
pag. 35

NEW

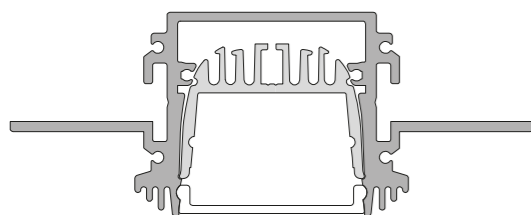

zero35 m
pag. 149

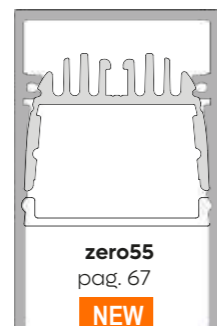

zero55
pag. 67

NEW

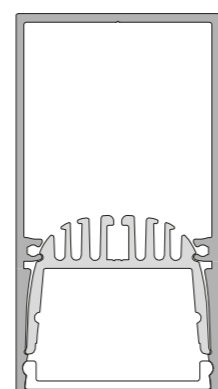

zero65 - p
pag. 161 + 169

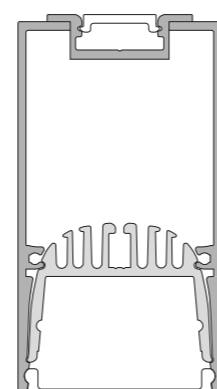

zero65 x + xp
pag. 181



ut01
pag. 347

NEW

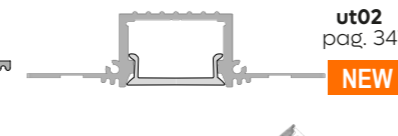

ut02
pag. 347

NEW

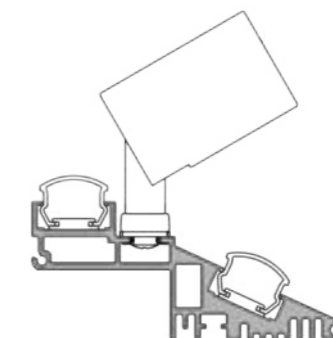

float i/k/l
presente nel
Volume 2.25.1

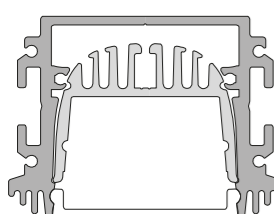

zero35 t
pag. 149

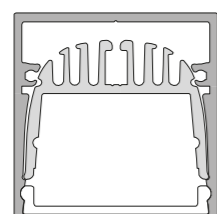

zero35 - p
pag. 111 + 137

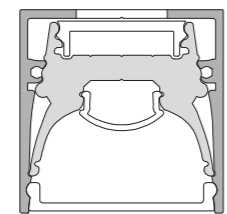

zero35 x
pag. 127



virgola
presente nel
Volume 2.25.1

NEW



mancorrente
presente nel
Volume 2.25.1

tratti di luce

irid 22 – irid 33 [27](#)
 tris [31](#)
 spigolo [35](#)
 t23 + t24 + m24 [43](#)
 in + out [55](#)
 kepler [61](#)
 zero55 [67](#)
 zero75 [85](#)
 zero35 [111](#)
 zero35x [127](#)
 zero35 – p [137](#)
 zero35 spot advanced [145](#)
 zero35 t + zero35 m [149](#)
 zero65 [161](#)
 zero65 p [169](#)
 zero65x + zero65xp [181](#)
 zero65 spot advanced [195](#)
 zero66 [199](#)
 q10 [207](#)
 q20 [215](#)
 structurae [225](#)
 k40 [237](#)
 k25 [245](#)
 k15 [255](#)
 s21 [263](#)
 ch012 [269](#)
 lc020 [279](#)
 lc014 [287](#)
 lc021 [303](#)
 sc015 [313](#)
 ms07 [321](#)
 ms08 [327](#)
 ms09 [335](#)
 ut01 + ut02 [347](#)
 u01 [355](#)
 u02 + u02 spot [371](#)
 u03 [391](#)
 mira [401](#)
 mc01 + mc02 [407](#)
 mf01 [413](#)
 mf02 [417](#)
 quadra [421](#)
 hydria quadro [425](#)
 hydria tondo [425](#)
 flama quadra [425](#)
 flama tondo [425](#)

led new generation

led new generation [433](#) flex led [433](#)
 led rgb [463](#)
 rgb ultraslim [463](#)
 led rgbw [463](#)
 led rgbtw [463](#)
 led tw [463](#)

accessori

driver 24V IP20 [471](#)
 driver mA IP20 [471](#)
 driver IP67 [471](#)
 emergency driver [473](#)
 dimmer [473](#)
 light control [475](#)



“una storia di passione nella luce a led”

Design Luce nasce a Firenze nell'anno 2000, figlia di una mente creativa e lungimirante, quella di Luigi Cerbone. Napoletano di nascita e toscano di adozione, con un'importante gavetta sulle spalle e un passato da agente nel settore dell'elettrotecnica, Cerbone decide di dedicarsi all'illuminazione. Lo fa con la consapevolezza che è la differenza a fare la differenza: serve un prodotto di eccellenza, funzionale ma elegante, specifico e ricercato. La partenza è la fluorescenza che poi viene implementata con l'avvento del LED, per arrivare all'utilizzo dell'alluminio, la componente indispensabile per la dissipazione del LED. Più flusso, più illuminazione, insomma. Ed è proprio grazie a questo materiale altamente lavorabile che la luce, quella che per Cerbone ha sempre rappresentato vita, benessere e bellezza, incontra il design. Nella sua azienda vengono creati profili italiani studiati da esperti con un occhio sempre puntato su eleganza e raffinatezza.

Design Luce was born in Florence in 2000, the daughter of a creative and far-sighted mind, that of Luigi Cerbone. Neapolitan by birth and Tuscan by adoption, with an important background and a past as an agent in the electrical engineering sector, Cerbone decided to dedicate himself to lighting. He did so with the awareness that it is the difference that makes the difference: you need a product of excellence, functional but elegant, specific and refined. The starting point was fluorescence, which was then implemented with the advent of LEDs, to arrive at the use of aluminium, the essential component for LED dissipation. More flux, more light. And it is thanks to this highly workable material that light, which for Cerbone has always represented life, wellbeing and beauty, meets design. His company creates Italian profiles designed by experts with an eye for elegance and refinement.

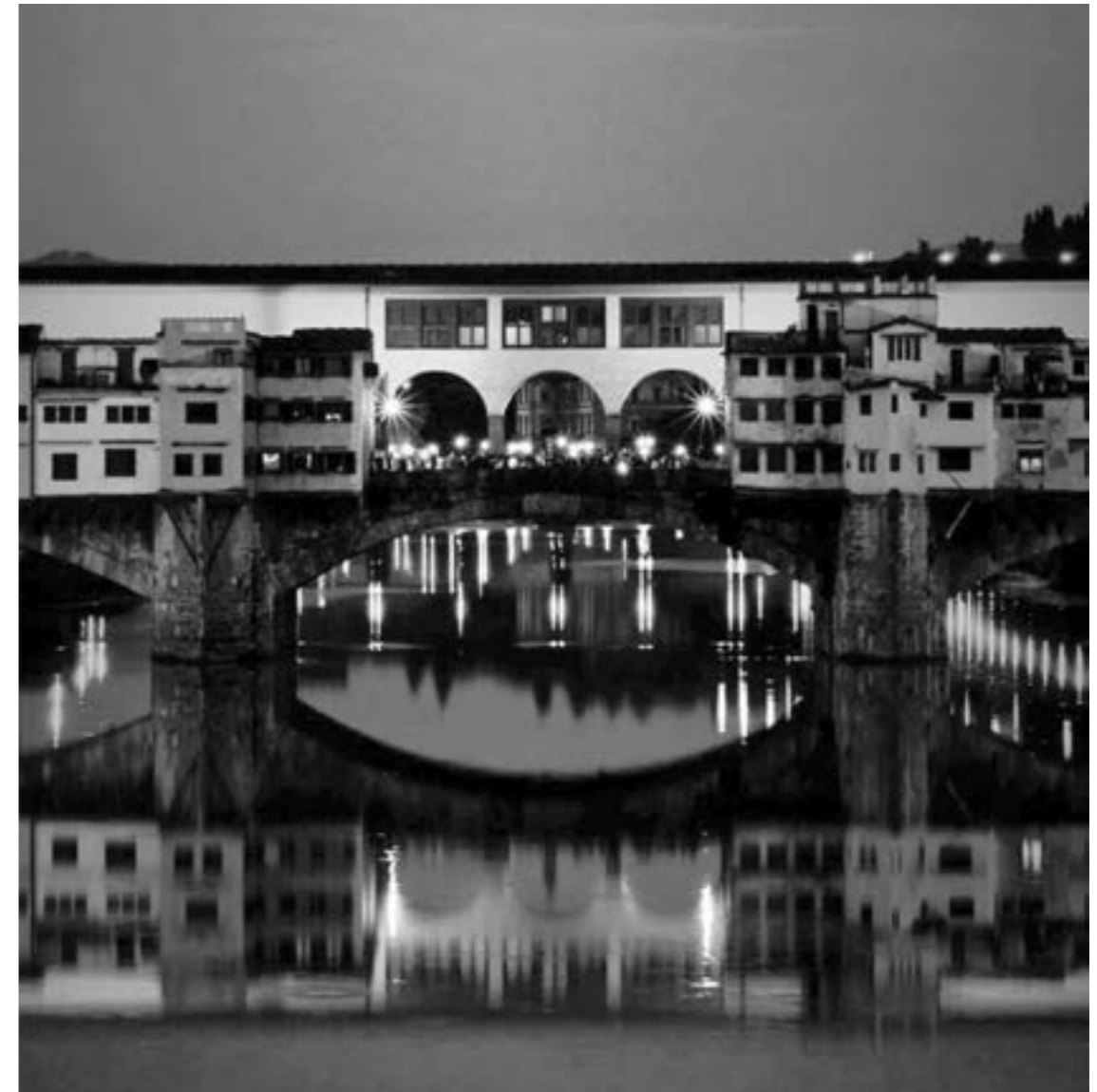

“rispondere a un’esigenza, soddisfare un bisogno”

Da 21 anni Luigi Cerbone è la mente di Design Luce. Le braccia sono quelle di 15 operai, tutti giovanissimi e altamente qualificati, che in quei 1000mq di azienda si sentono a casa. Perché, come è lo stesso Luigi Cerbone a ripetere, l’azienda deve rispecchiare il proprietario. Servono disponibilità e attenzione. Le stesse che Design Luce mette a disposizione del mercato. Un mercato nel quale le regole sono state invertire. Con l’azienda toscana, infatti, gli architetti non si

trovano più costretti a scegliere lampade di dimensioni fisse da adattare al loro progetto ma possono avere un prodotto ad hoc a seconda delle proprie idee. La filosofia, che da subito si configura come mission aziendale, è quella di rispondere a un’esigenza, soddisfare un bisogno, avere risposte pronte. Creare luce attraverso il design sperimentando forme nuove, trasformando un’idea in un progetto di luce. Esaltare la bellezza, illuminarla al meglio.

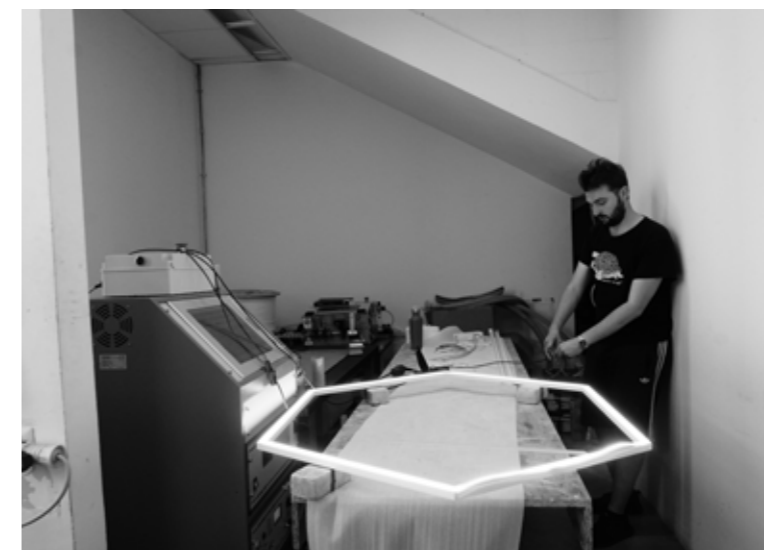

Luigi Cerbone has been the mind of Design Luce for 21 years. The arms are those of 15 workers, all very young and highly qualified, who feel at home in those 1000sqm of company. Because, as Luigi Cerbone himself repeats, the company must reflect the owner. Availability and attention are needed. The same ones that Design Luce makes available to the market. A market in which the rules have been reversed. With the Tuscan company, in fact, architects are no longer forced to choose lamps of fixed dimensions to adapt to their project but can have an ad hoc product according to their ideas. The philosophy, which immediately takes the form of a corporate mission, is to respond to a need, satisfy a need, have ready answers. Creating light through design by experimenting with new forms, transforming an idea into a light project. Enhance beauty, illuminate it to the fullest.

“dissipazione, innovazione e alti livelli di qualità”

ALLUMINIO E DISSIPAZIONE

Design Luce è la prima azienda italiana ad aver profondamente capito l'importanza delle dissipazioni del calore delle sorgenti luminose flessibili a LED.

Tutti i profili prodotti sono in alluminio estruso e sono stati progettati allo scopo di garantire la dissipazione ottimale del calore generato dalla sorgente luminosa.

Spessore di alluminio 100% italiano > 1,5 mm = Dissipazione ottimale del calore = Elevata durata della sorgente luminosa

LED CRI>95 E LED CRI>97

La tecnologia LED ha portato una notevole innovazione nel panorama illuminotecnico: ai tradizionali parametri utilizzati per la classificazione delle lampade alogene e a scarica si sono aggiunti nuovi criteri di valutazione fotometrica. I LED flessibili di Design Luce presentano alti livelli qualitativi e garantiscono la massima resa cromatica nonché un notevole comfort visivo.

ALUMINUM AND DISSIPATION

Design Luce is the first Italian company to have deeply understood the importance of heat dissipation from flexible LED light sources.

All the profiles produced are in extruded aluminum and have been designed in order to ensure optimal dissipation of the heat generated by the light source.

100% Italian aluminum thickness > 1.5 mm = Optimal heat dissipation = Long duration of the light source

LED CRI> 95 AND LED CRI> 97

LED technology has brought considerable innovation to the lighting panorama: new photometric evaluation criteria have been added to the traditional parameters used for the classification of halogen and discharge lamps. The flexible LEDs of Design Luce have high quality levels and guarantee maximum color rendering as well as considerable visual comfort.

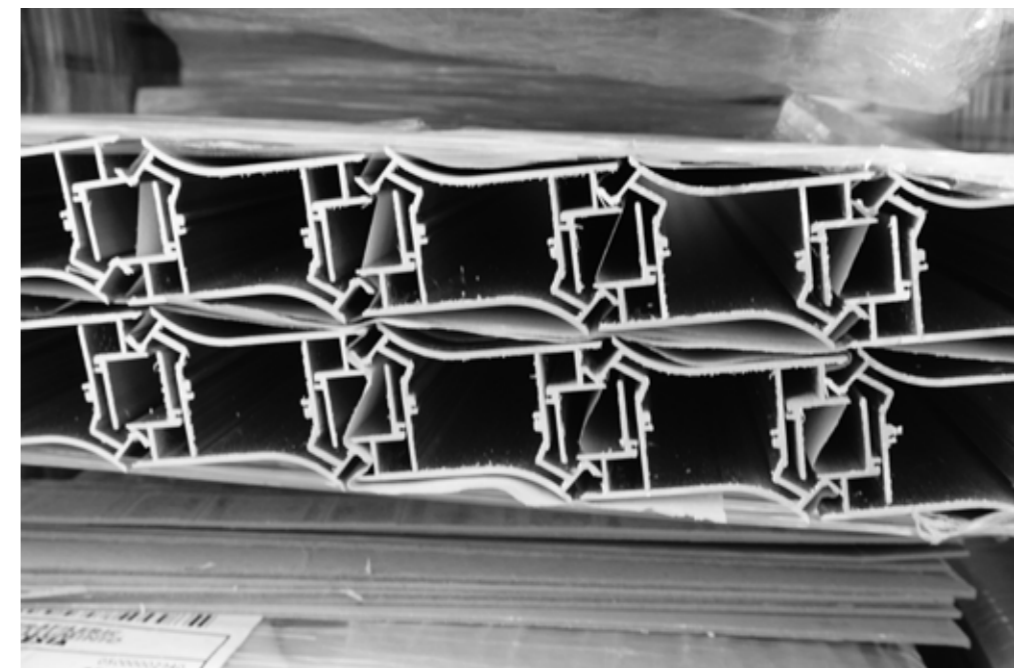
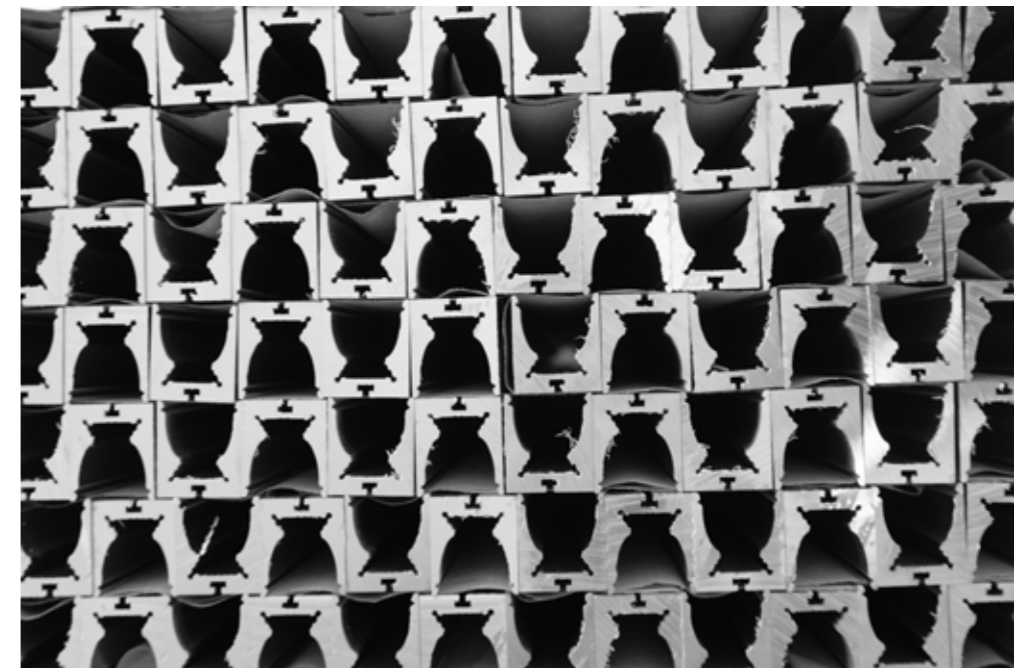

“ricerca, investimenti mirati e costanti, manodopera specializzata”

Alla base di un prodotto di qualità ci sono ricerca, investimenti mirati e costanti, manodopera specializzata. Tutti i nostri prodotti sono collaudati e testati 100% con uno strumento di verifica che gli conferisce la conformità alle norme CEI e la marcatura CE. Ma l'alta qualità è data anche dalla passione per il proprio lavoro e dalla volontà di soddisfare a pieno le esigenze dei clienti che quotidianamente si rivolgono alla Design Luce per illuminare ogni loro istante.

At the base of a quality product there are research, targeted and constant investments, skilled labor. All our products are tested and tested 100% with a verification tool that gives them compliance with CEI standards and CE marking. But the high quality is also given by the passion for their work and the desire to fully satisfy the needs of customers who daily turn to Design Luce to illuminate their every moment.

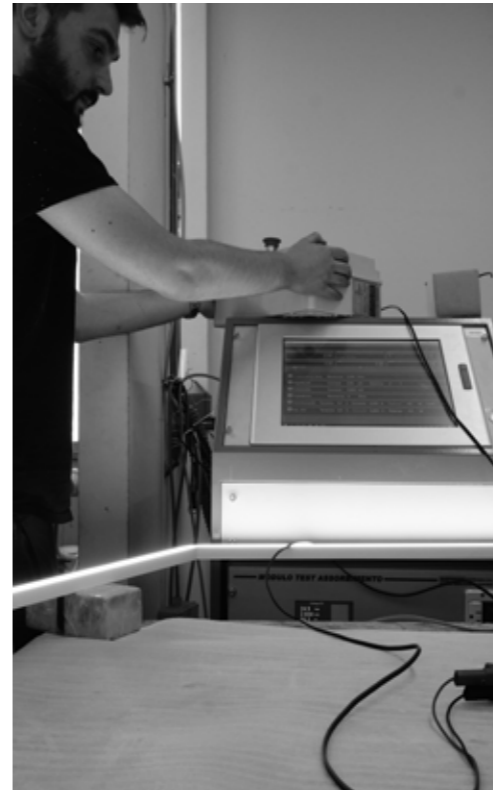

“dall'estetica di un impercettibile segmento luminoso allo stupore di una luce diffusa e a spot”

Dall'estetica di un impercettibile segmento luminoso allo stupore di una luce diffusa e a spot nello spazio, mantenendo inalterato l'alto livello di efficienza luminosa.

LED flessibili di alta qualità progettati dal nostro ufficio tecnico e realizzati appositamente per la Design Luce al fine di garantire un prodotto unico e a “misura” di progetto.

From the aesthetics of an imperceptible light segment to the amazement of a diffused light in the space while maintaining the high level of luminous efficiency.

High quality flexible LEDs designed by our technical department and made specifically for Design Luce in order to guarantee a unique product tailored to the project.



“un prodotto su misura che si adatta perfettamente al cliente”

La Design Luce nasce con un obiettivo preciso: realizzare un prodotto su misura che si adatti perfettamente al cliente, esattamente come un abito di alta sartoria. Grazie alla possibilità del “taglio a misura al cm” lineare e angolare, ad un’ampia gamma di finiture e a specifici accessori per ogni tipologia di installazione, si ottiene un’elevata versatilità nella realizzazione dei progetti. Versatilità unita ad un’eleganza inconfondibile che parla la lingua del Made in Italy. Profili in alluminio estruso, diffusori in policarbonato opali, satinati e prismatici, accessori e minuteria: ogni singolo prodotto di Design Luce è progettato e interamente realizzato in Italia grazie alla collaborazione con le migliori aziende certificate del settore.

Design Luce was born with a specific goal: to create a tailor-made product that fits perfectly to the customer, just like a haute couture suit. Thanks to the possibility of the linear and angular “cut to size per cm”, a wide range of finishes and specific accessories for each type of installation, a high versatility is obtained in the realization of projects. Versatility combined with an unmistakable elegance that speaks the language of Made in Italy. Extruded aluminum profiles, opal, satin and prismatic polycarbonate diffusers, accessories and small parts: every single Design Luce product is designed and entirely made in Italy thanks to the collaboration with the best certified companies in the sector.

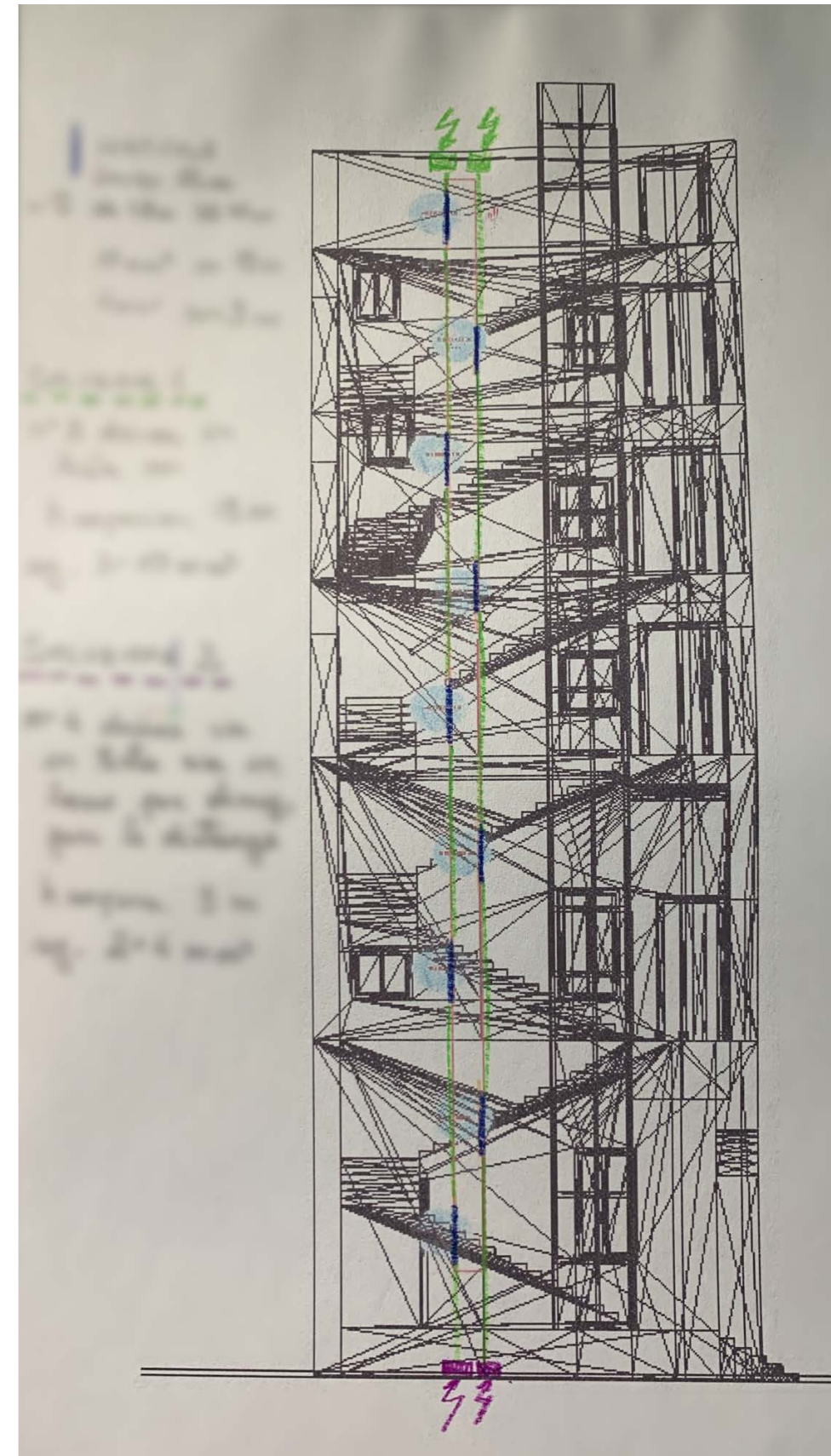

“le finiture dei profili uniscono funzionalità ed eleganza”

Le finiture dei profili uniscono funzionalità ed eleganza.

Il nero non è il solo colore utilizzato: in alternativa troviamo numerose tonalità, alcune classiche e sofisticate come il bianco e i grigi, altre decisamente più particolari come l'oro. La scelta è ampia e sottolinea la costante volontà di offrire prodotti di design perfettamente adattabili ad ogni ambiente.

The finishes of the profiles combine functionality and elegance.

Black is not the only color used: alternatively we find numerous shades, some classic and sophisticated such as white and grays, others decidedly more particular such as gold. The choice is wide and underlines the constant desire to offer design products that are perfectly adaptable to any environment.

finishes

customization

design luce



00. grigio vesuvio



01. argilla



02. argento opaco



03. bianco intonaco



04. nero caravaggio



05. moka



08. cromo



09. oro california



10. aramen



11. grigio avio



12. argento cometa



13. ottone veneziano



14. titanio

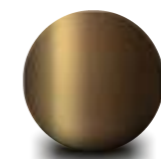

15. bronzo di riaci

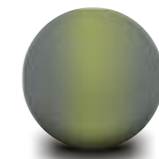

16. verde costa



17. terra senese



18. arancio ribera
NEW



19. sabbia marina
NEW

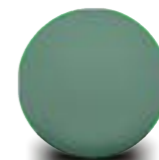

20. azzurro lido
NEW

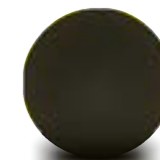

21. grigio ferraio
NEW



22. visone boreale
NEW

possibilità di personalizzazione del colore — possibility of customizing the color

light+building

“una realtà dinamica in forte espansione”

Design Luce è una realtà dinamica in continua espansione, non solo a livello italiano, nel quale si è ritagliata un ruolo di prestigio. L'obiettivo è la crescita nel mercato europeo. Due sono state le partecipazioni importanti: la prima al nostrano Salone del mobile di Milano, la seconda al Salone di Francoforte.

In entrambi gli eventi Design Luce ha dimostrato di essere un forte competitor in un settore in continuo sviluppo.

Design Luce is a dynamic reality in continuous expansion, not only on an Italian level, in which it has carved out a prestigious role. The goal is growth in the European market. There were two important participations: the first at our Milan Furniture Fair, the second at the Frankfurt Motor Show.

In both events, Design Luce proved to be a strong competitor in a continuously developing sector.

stand

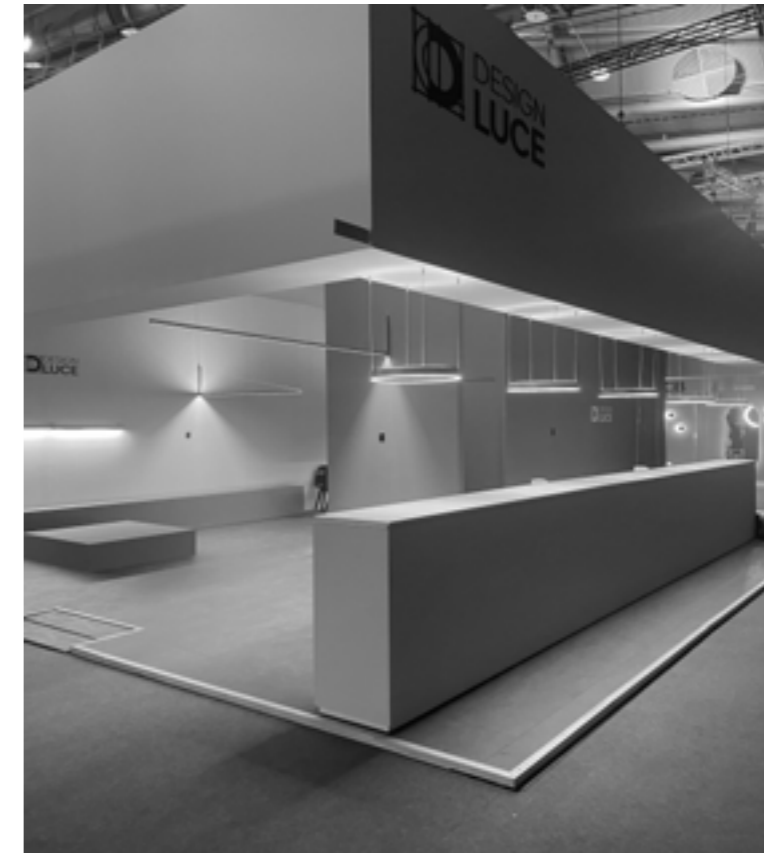

 Salone del Mobile. Milano



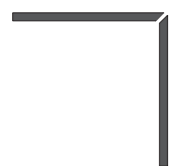
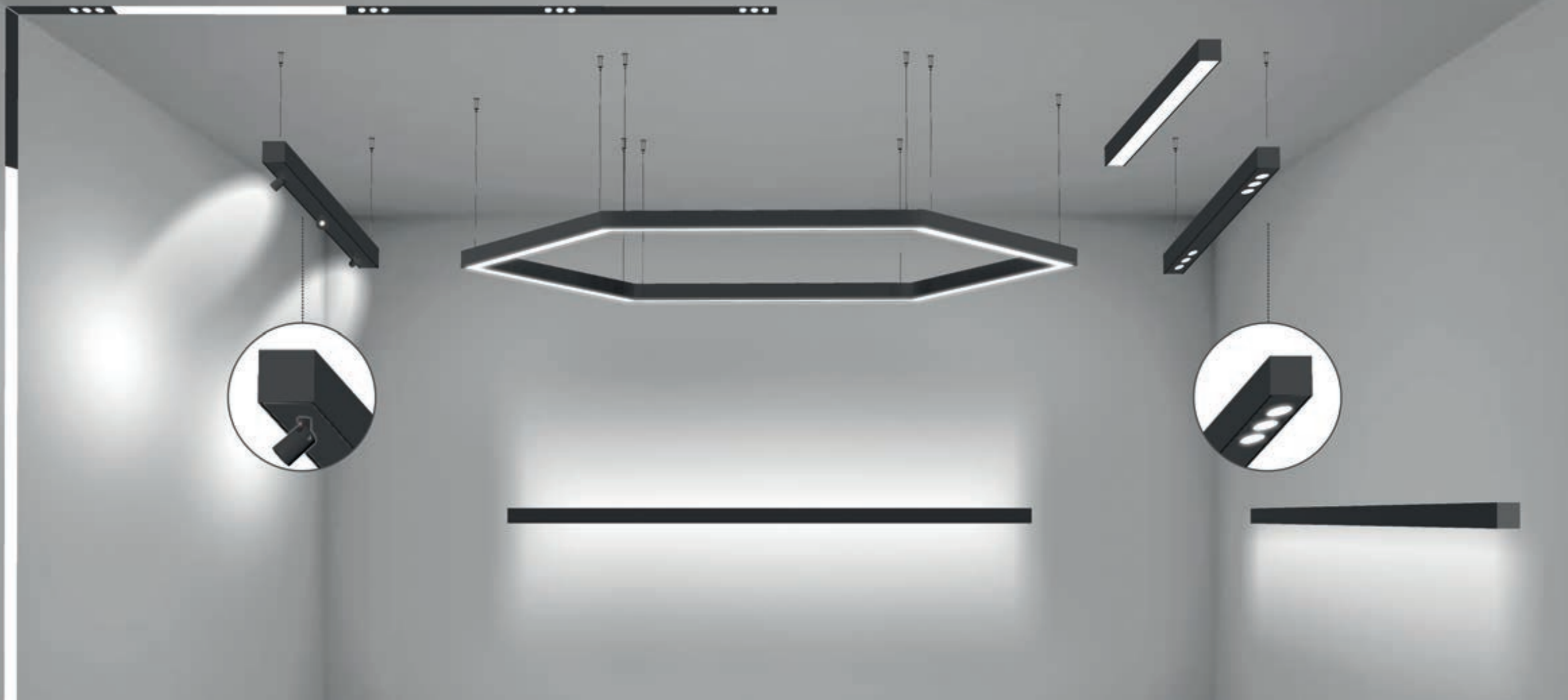

A. COMPOSIZIONE ANGOLARE A "L"
A. L-ANGLE COMPOSITION

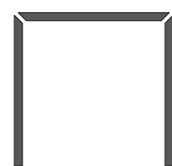

B. COMPOSIZIONE ANGOLARE A "C"
B. C-ANGLE COMPOSITION

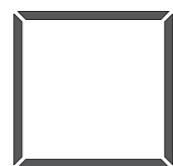

C. COMPOSIZIONE POLIGONALE (QUADRATO/RETTANGOLO)
C. POLYGONAL COMPOSITION (SQUARE / RECTANGLE)



D. COMPOSIZIONE POLIGONALE (PENTAGONO/ESAGONO)
D. POLYGONAL COMPOSITION (PENTAGON / HEX)



UT02

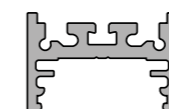

U02

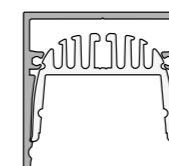

ZER035

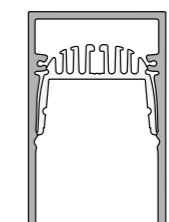

ZER055

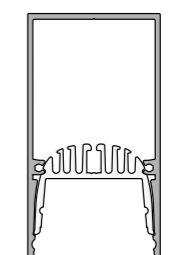

ZER065

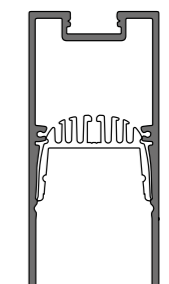

ZER075

Sistemi modulari personalizzabili
Modular sistem custom

irid 22 irid 33

**“luce a Spot
per tutti gli attori del settore”**

IRID è l'inizio di una serie di progetti in cui si evince la ferma convinzione di design luce ad affrontare con decisione il tema della luce a Spot, offrendo a tutti gli attori del settore, Architetti, lighting, Ingegneri, non un solo prodotto, ma una gamma di soluzioni in cui i fasci luminosi per mezzo di gruppi ottici ne diventano i protagonisti. Ideali per il settore retail, ma anche per i musei o gallerie d'arte, dove la luce spesso viene chiamata ad assolvere compiti in cui è richiesta una qualità del comfort visivo alta.

IRID is the beginning of a series of projects in which the firm conviction of design light is evident in tackling the theme of light with decision at Spot, offering all the players in the sector, Architects, lighting, Engineers, not a single product, but a range of solutions in which the light beams do not become the protagonists by means of optical groups. Ideal for the retail sector, but also for museums or art galleries, where light is often called upon to perform tasks where a high quality of visual comfort is required.

irid 22
irid 33



luigi cerbone





Compatibile con i profili / Compatible with profiles

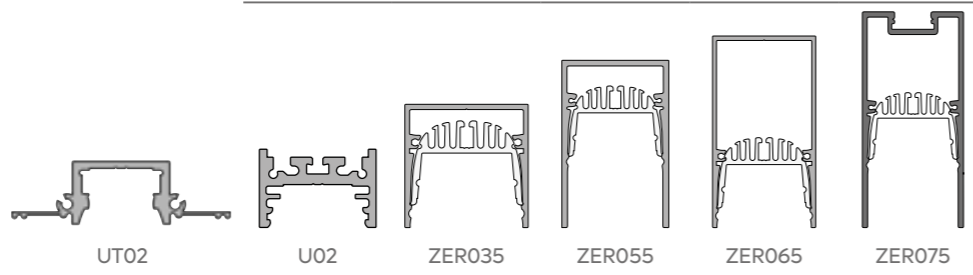

DATI TECNICI
TECHNICAL DATA

Flux Tot: 180-190-200 lm
Output: 112 lm/W
CCT: 2700- 3000-4000 K
CRI: 90
Power Tot: 1.7W / 700 mA
Fascio: 25°

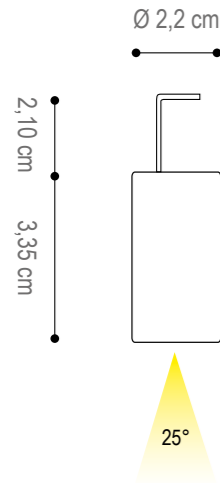

FINITURA
FINISHES

- GRIGIO VESUVIO ANTHRACITE
- ARGILLA CLAY
- BIANCO INTONACO/WHITE
- NERO CARAVAGGIO BLACK
- MOKA MOCHA
- CROMO/CHROME
- ORO CALIFORNIA/GOLD
- ARAMEN COPPER
- ARGENTO COMETA/SILVER COMET
- OTTONE VENEZIANO BRASS
- TITANIO/TITANIUM
- BRONZO RIACI/RIACI BRONZE
- VERDE COSTA/GREEN COAST
- TERRA SENESE SENESE EARTH

CODICE 2700K CODE 2700K	CODICE 3000K CODE 3000K	CODICE 4000K CODE 4000K
22C70024	22C80024	22C90024
22C70124	22C80124	22C90124
22C70324	22C80324	22C90324
22C70424	22C80424	22C90424
22C70524	22C80524	22C90524
22C70824	22C80824	22C90824
22C70924	22C80924	22C90924
22C71024	22C81024	22C91024
22C71224	22C81224	22C91224
22C71324	22C81324	22C91324
22C71424	22C81424	22C91424
22C71524	22C81524	22C91524
22C71624	22C81624	22C91624
22C71724	22C81724	22C91724

DRIVER NON INCLUSO



Compatibile con i profili / Compatible with profiles

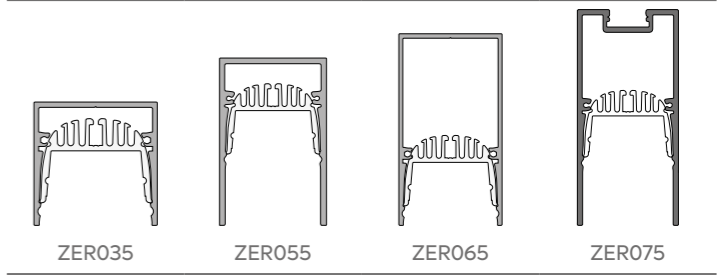

DATI TECNICI
TECHNICAL DATA

Flux Tot: 475-500-525 lm
Output: 100 lm/W
CCT: 2700-3000-4000K
CRI: 90
Power Tot: 5.0W / 700 mA
Fascio: 25°

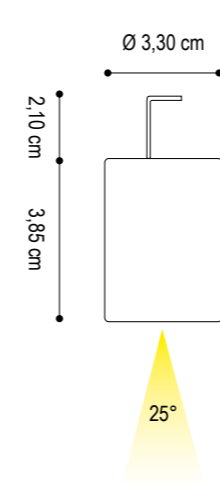

FINITURA
FINISHES

- GRIGIO VESUVIO ANTHRACITE
- ARGILLA CLAY
- BIANCO INTONACO/WHITE
- NERO CARAVAGGIO BLACK
- MOKA MOCHA
- CROMO/CHROME
- ORO CALIFORNIA/GOLD
- ARAMEN COPPER
- ARGENTO COMETA/SILVER COMET
- OTTONE VENEZIANO BRASS
- TITANIO/TITANIUM
- BRONZO RIACI/RIACI BRONZE
- VERDE COSTA/GREEN COAST
- TERRA SENESE SENESE EARTH

CODICE 2700K CODE 2700K	CODICE 3000K CODE 3000K	CODICE 4000K CODE 4000K
33CA0024	33CB0024	33CC0024
33CA0124	33CB0124	33CC0124
33CA0324	33CB0324	33CC0324
33CA0424	33CB0424	33CC0424
33CA0524	33CB0524	33CC0524
33CA0824	33CB0824	33CC0824
33CA0924	33CB0924	33CC0924
33CA1024	33CB1024	33CC1024
33CA1224	33CB1224	33CC1224
33CA1324	33CB1324	33CC1324
33CA1424	33CB1424	33CC1424
33CA1524	33CB1524	33CC1524
33CA1624	33CB1624	33CC1624
33CA1724	33CB1724	33CC1724

DRIVER NON INCLUSO

DATI TECNICI
TECHNICAL DATA

Flux Tot: 475-500-525 lm
Output: 100 lm/W
CCT: 2700-3000-4000K
CRI: 90
Power Tot: 5.0W / 700 mA
Fascio: 35°

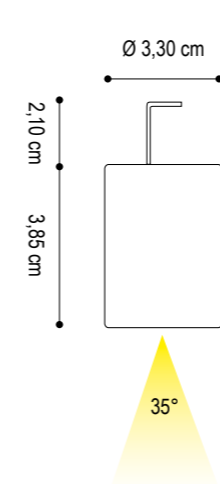

FINITURA
FINISHES

- GRIGIO VESUVIO ANTHRACITE
- ARGILLA CLAY
- BIANCO INTONACO/WHITE
- NERO CARAVAGGIO BLACK
- MOKA MOCHA
- CROMO/CHROME
- ORO CALIFORNIA/GOLD
- ARAMEN COPPER
- ARGENTO COMETA/SILVER COMET
- OTTONE VENEZIANO BRASS
- TITANIO/TITANIUM
- BRONZO RIACI/RIACI BRONZE
- VERDE COSTA/GREEN COAST
- TERRA SENESE SENESE EARTH

CODICE 2700K CODE 2700K	CODICE 3000K CODE 3000K	CODICE 4000K CODE 4000K
33CA0036	33CB0036	33CC0036
33CA0136	33CB0136	33CC0136
33CA0336	33CB0336	33CC0336
33CA0436	33CB0436	33CC0436
33CA0536	33CB0536	33CC0536
33CA0836	33CB0836	33CC0836
33CA0936	33CB0936	33CC0936
33CA1036	33CB1036	33CC1036
33CA1236	33CB1236	33CC1236
33CA1336	33CB1336	33CC1336
33CA1436	33CB1436	33CC1436
33CA1536	33CB1536	33CC1536
33CA1636	33CB1636	33CC1636
33CA1736	33CB1736	33CC1736

DRIVER NON INCLUSO



**“fasci luminosi che per mezzo
di gruppi ottici nè diventano i protagonisti”**

TRIS è l'inizio di una serie di progetti in cui si evince la ferma convinzione di design luce ad affrontare con decisione il tema della luce a Spot, offrendo a tutti gli attori del settore, Architetti, lighting, Ingegneri, non un solo prodotto, ma una gamma di soluzioni in cui i fasci luminosi per mezzo di gruppi ottici nè diventano i protagonisti. Ideali per il settore retail, ma anche per i musei o gallerie d'arti, dove la luce spesso viene chiamata ad assolvere compiti in cui è richiesta una qualità del comfort visivo alta.

TRIS is the beginning of a series of projects in which the firm conviction of design light is evident in tackling the theme of light with decision at Spot, offering all the players in the sector, Architects, lighting, Engineers, not a single product, but a range of solutions in which the light beams do not become the protagonists by means of optical groups. Ideal for the retail sector, but also for museums or art galleries, where light is often called upon to perform tasks where a high quality of visual comfort is required.



Compatibile con il profilo / Compatible with profiles

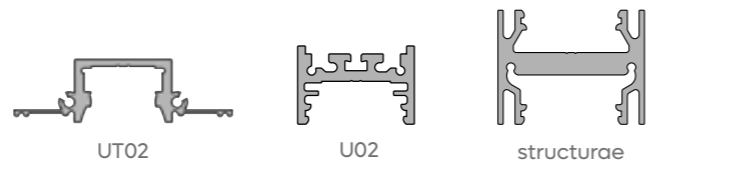

DATI TECNICI
TECHNICAL DATA

Flux Tot: 625-660-695 lm
Output: 105 lm/W
CCT: 2700-3000-4000K
CRI: 90
LENS Power Tot: 6.3W 700mA
Fascio: 25°

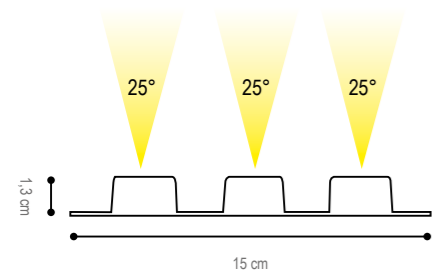

DRIVER NON INCLUSO

FINITURA
FINISHES

- GRIGIO VESUVIO ANTHRACITE
- ARGILLA CLAY
- ARGENTO OPACO/MATT SILVER
- BIANCO INTONACO/WHITE
- NERO CARAVAGGIO BLACK
- MOKA MOCHA
- CROMO/CHROME
- ORO CALIFORNIA/GOLD
- ARAMEN COPPER
- GRIGIO AVIO/GREY AVIO
- ARGENTO COMETA/SILVER COMET
- OTTONE VENEZIANO BRASS
- TITANIO/TITANIUM
- BRONZO RIACI/RIACI BRONZE
- VERDE COSTA/GREEN COAST
- TERRA SENESE SENESE EARTH

CODICE 2700K CODE 2700K	CODICE 3000K CODE 3000K	CODICE 4000K CODE 4000K
26F20025	26F30025	26F40025
26F20125	26F30125	26F40125
26F20225	26F30225	26F40225
26F20325	26F30325	26F40325
26F20425	26F30425	26F40425
26F20525	26F30525	26F40525
26F20825	26F30825	26F40825
26F20925	26F30925	26F40925
26F21025	26F31025	26F41025
26F21125	26F31125	26F41125
26F21225	26F31225	26F41225
26F21325	26F31325	26F41325
26F21425	26F31425	26F41425
26F21525	26F31525	26F41525
26F21625	26F31625	26F41625
26F21725	26F31725	26F41725

DATI TECNICI
TECHNICAL DATA

Flux Tot: 625-660-695 lm
Output: 105 lm/W
CCT: 2700-3000-4000K
CRI: 90
LENS Power Tot: 6.3W 700mA
Fascio: 40°

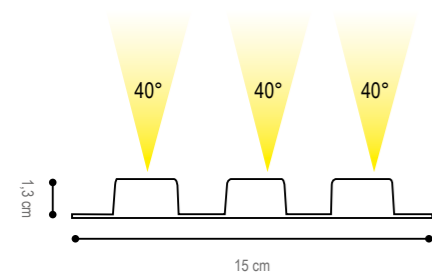

DRIVER NON INCLUSO

FINITURA
FINISHES

- GRIGIO VESUVIO ANTHRACITE
- ARGILLA CLAY
- ARGENTO OPACO/MATT SILVER
- BIANCO INTONACO/WHITE
- NERO CARAVAGGIO BLACK
- MOKA MOCHA
- CROMO/CHROME
- ORO CALIFORNIA/GOLD
- ARAMEN COPPER
- GRIGIO AVIO/GREY AVIO
- ARGENTO COMETA/SILVER COMET
- OTTONE VENEZIANO BRASS
- TITANIO/TITANIUM
- BRONZO RIACI/RIACI BRONZE
- VERDE COSTA/GREEN COAST
- TERRA SENESE SENESE EARTH

CODICE 2700K CODE 2700K	CODICE 3000K CODE 3000K	CODICE 4000K CODE 4000K
26F20040	26F30040	26F40040
26F20140	26F30140	26F40140
26F20240	26F30240	26F40240
26F20340	26F30340	26F40340
26F20440	26F30440	26F40440
26F20540	26F30540	26F40540
26F20840	26F30840	26F40840
26F20940	26F30940	26F40940
26F21040	26F31040	26F41040
26F21140	26F31140	26F41140
26F21240	26F31240	26F41240
26F21340	26F31340	26F41340
26F21440	26F31440	26F41440
26F21540	26F31540	26F41540
26F21640	26F31640	26F41640
26F21740	26F31740	26F41740

Compatibile con i profili / Compatible with profiles

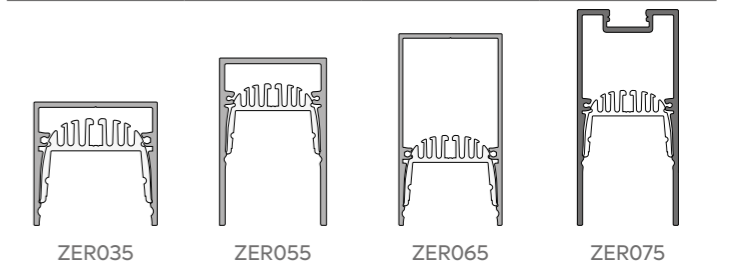

DATI TECNICI
TECHNICAL DATA

Flux Tot: 625-660-695 lm
Output: 105 lm/W
CCT: 2700-3000-4000K
CRI: 90
LENS Power Tot: 6.3W 700mA
Fascio: 25°

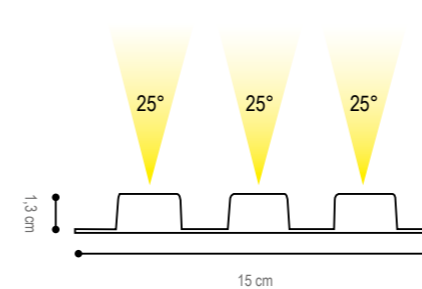

DRIVER NON INCLUSO

FINITURA
FINISHES

- GRIGIO VESUVIO ANTHRACITE
- ARGILLA CLAY
- ARGENTO OPACO/MATT SILVER
- BIANCO INTONACO/WHITE
- NERO CARAVAGGIO BLACK
- MOKA MOCHA
- CROMO/CHROME
- ORO CALIFORNIA/GOLD
- ARAMEN COPPER
- GRIGIO AVIO/GREY AVIO
- ARGENTO COMETA/SILVER COMET
- OTTONE VENEZIANO BRASS
- TITANIO/TITANIUM
- BRONZO RIACI/RIACI BRONZE
- VERDE COSTA/GREEN COAST
- TERRA SENESE SENESE EARTH

CODICE 2700K CODE 2700K	CODICE 3000K CODE 3000K	CODICE 4000K CODE 4000K
55F20025	55F30025	55F40025
55F20125	55F30125	55F40125
55F20225	55F30225	55F40225
55F20325	55F30325	55F40325
55F20425	55F30425	55F40425
55F20525	55F30525	55F40525
55F20825	55F30825	55F40825
55F20925	55F30925	55F40925
55F21025	55F31025	55F41025
55F21125	55F31125	55F41125
55F21225	55F31225	55F41225
55F21325	55F31325	55F41325
55F21425	55F31425	55F41425
55F21525	55F31525	55F41525
55F21625	55F31625	55F41625
55F21725	55F31725	55F41725

DATI TECNICI
TECHNICAL DATA

Flux Tot: 625-660-695 lm
Output: 105 lm/W
CCT: 2700-3000-4000K
CRI: 90
LENS Power Tot: 6.3W 700mA
Fascio: 40°

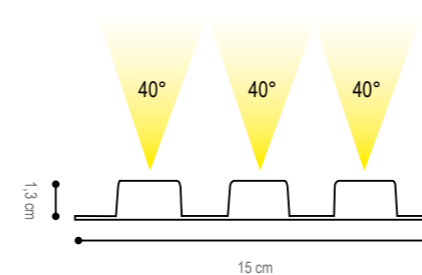

DRIVER NON INCLUSO

FINITURA
FINISHES

- GRIGIO VESUVIO ANTHRACITE
- ARGILLA CLAY
- ARGENTO OPACO/MATT SILVER
- BIANCO INTONACO/WHITE
- NERO CARAVAGGIO BLACK
- MOKA MOCHA
- CROMO/CHROME
- ORO CALIFORNIA/GOLD
- ARAMEN COPPER
- GRIGIO AVIO/GREY AVIO
- ARGENTO COMETA/SILVER COMET
- OTTONE VENEZIANO BRASS
- TITANIO/TITANIUM
- BRONZO RIACI/RIACI BRONZE
- VERDE COSTA/GREEN COAST
- TERRA SENESE SENESE EARTH

CODICE 2700K CODE 2700K	CODICE 3000K CODE 3000K	CODICE 4000K CODE 4000K
55F20040	55F30040	55F40040
55F20140	55F30140	55F40140
55F20240	55F30240	55F40240
55F20356	55F30556	55F40556
55F20440	55F30440	55F40440
55F20540	55F30540	55F40540
55F20840	55F30840	55F40840
55F20940	55F30940	55F40940
55F21040	55F31040	55F41040
55F21140	55F31140	55F41140
55F21240	55F31240	55F41240
55F21340	55F31340	55F41340
55F21440	55F31440	55F41440
55F21540	55F31540	55F41540
55F21640	55F31640	55F41640
55F21740	55F31740	55F41740

“armonia, estetica e funzionalità”

Spigolo 23 è un sistema studiato in estruso d'alluminio, capace di integrarsi perfettamente in pareti o soffitti di cartongesso contribuendo a diminuire gli spessori. La sua forma armonica, funzionale ed estetica, abbinata alla facilità nell'installazione, lo rendono indispensabile in tutti gli spazi architettonici in cui viene richiesta una luce diretta o indiretta. Spigolo 23 è un sistema ingegnerizzato, per alloggiare al suo interno led a luce diffusa, (bianca, Rgb o Tunable white) oppure all'occorrenza in grado di creare una luce puntuale usando apparecchi spot (irid 22/33), con gradi e flussi luminosi variabili a seconda dello spazio da disegnare.

Spigolo 23 is a system designed in extruded aluminum, capable of integrating perfectly into plasterboard walls or ceilings, helping to reduce thickness. Its harmonious, functional and aesthetic shape, combined with ease of installation, make it indispensable in all architectural spaces where direct or indirect light is required. Spigolo 23 is an engineered system to house diffused light LEDs (white, RGB or Tunable white) or, if necessary, capable of creating a punctual light using spot devices (irid 22/33), with variable degrees and luminous fluxes depending on the space to be designed.



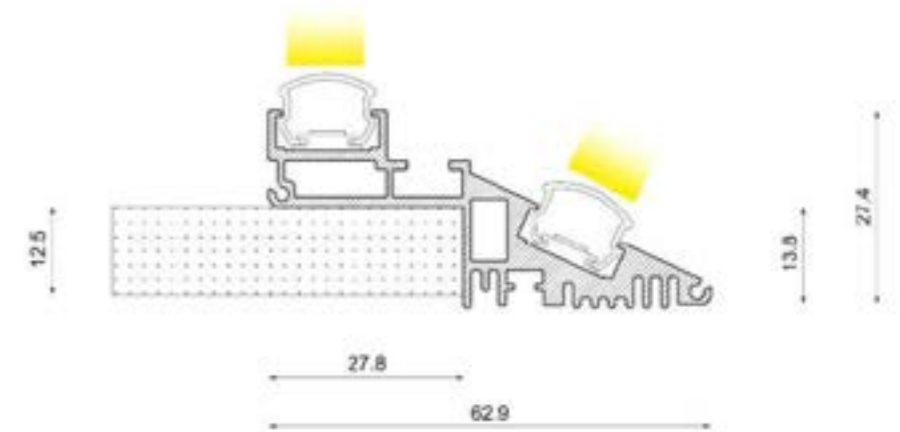
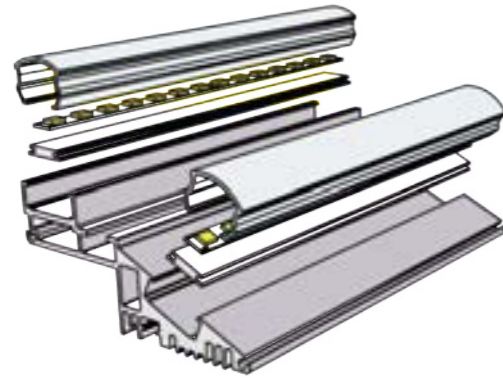

DATI TECNICI
TECHNICAL DATA

		1 cm	
Nominal LED Flux:		↑ 1114 lm - 1114 lm ↓	
Flux Tot:		↑ 891 lm - 891 lm ↓	
Output:		116 lm/W	
CCT:		3000 K	
CRI:		>90	
Power:		↑ 9,6 W/m - 9,6 W/m ↓	
Power Tot:		19,2 W/m	
Weight:		0.76 Kg/m	
Alluminio/aluminium		Cover: Opale/opal	

DIFFUSORE
DIFFUSER

BIANCO INTONACO/WHITE
ALLUMINIO NATURALE/ALUMINUM

OPALE/OPAL

		1 cm		200 cm		300 cm	
CODICE	PREZZO	CODICE	PREZZO	CODICE	PREZZO	CODICE	PREZZO
2700K	PRICE	2700K	PRICE	2700K	PRICE	2700K	PRICE
23J5032001		23J5032200		23J5032300			
23J5062001		23J5062200		23J5062300			
CODICE	PREZZO	CODICE	PREZZO	CODICE	PREZZO	CODICE	PREZZO
3000K	PRICE	3000K	PRICE	3000K	PRICE	3000K	PRICE
23J6032001		23J6032200		23J6032300			
23J6062001		23J6062200		23J6062300			
CODICE	PREZZO	CODICE	PREZZO	CODICE	PREZZO	CODICE	PREZZO
4000K	PRICE	4000K	PRICE	4000K	PRICE	4000K	PRICE
23J7032001		23J7032200		23J7032300			
23J7062001		23J7062200		23J7062300			

TESTATE DI CHIUSURA / DEAD ENDS

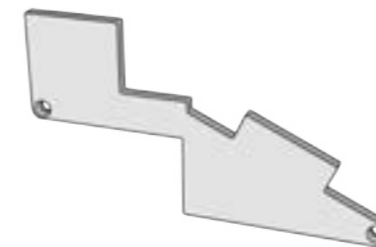

FINITURA STRUTTURA
FINISHES

CODICE
CODE

PREZZO
PRICE

BIANCO INTONACO/WHITE
ALLUMINIO NATURALE/ALUMINUM

230403
230406

N.B. Il codice contiene n° 2 testate di chiusura / The code contains 2 closing dead ends

spigolo 23

una cover + led non integrato



DIFFUSORE
DIFFUSER

		1 cm		200 cm		300 cm	
	OPALE/OPAL	CODICE CODE	PREZZO PRICE	CODICE CODE	PREZZO PRICE	CODICE CODE	PREZZO PRICE
BIANCO INTONACO/WHITE		23CP030001		23CP030200		23CP030300	
ALLUMINIO NATURALE/ALUMINUM		23CP060001		23CP060200		23CP060300	

BIANCO INTONACO/WHITE
ALLUMINIO NATURALE/ALUMINUM

OPALE/OPAL

due cover + led non integrato



DIFFUSORE
DIFFUSER

		1 cm		200 cm		300 cm	
	OPALE/OPAL	CODICE CODE	PREZZO PRICE	CODICE CODE	PREZZO PRICE	CODICE CODE	PREZZO PRICE
BIANCO INTONACO/WHITE		23CP032001		23CP032200		23CP032300	
ALLUMINIO NATURALE/ALUMINUM		23CP062001		23CP062200		23CP062300	

BIANCO INTONACO/WHITE
ALLUMINIO NATURALE/ALUMINUM

OPALE/OPAL

spigolo 23

led non integrato

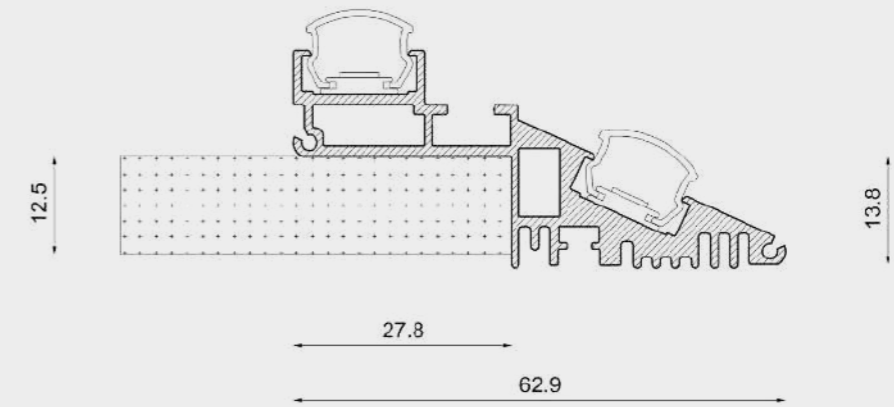
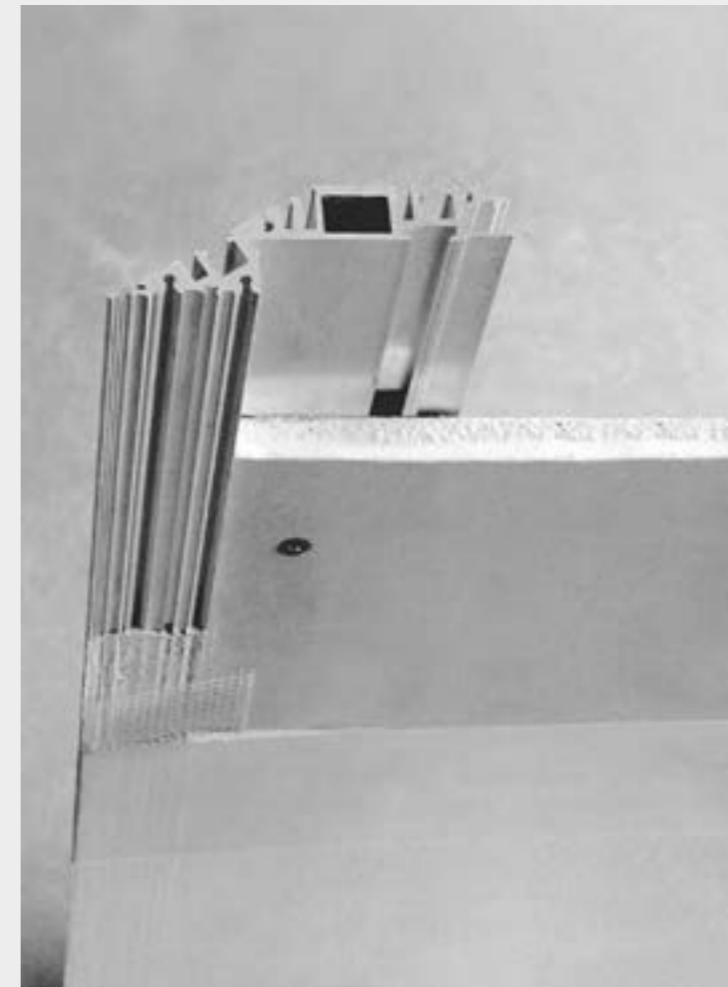

spigolo 23

spot integrato Irid 22

integrated spot Irid 22

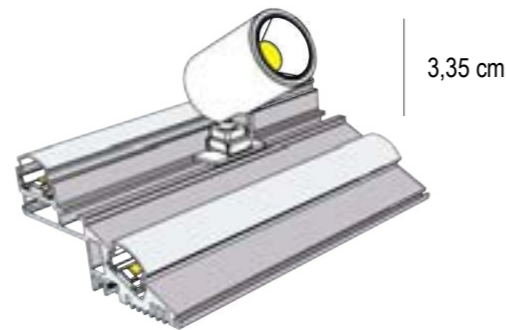

DRIVER NON INCLUSO

DATI TECNICI
TECHNICAL DATA

Flux Tot: 180-190-200 lm
Output: 112 lm/W
CCT: 2700-3000-4000K
CRI: 90
Power Tot: 1.7W / 700 mA
Fascio: 25°

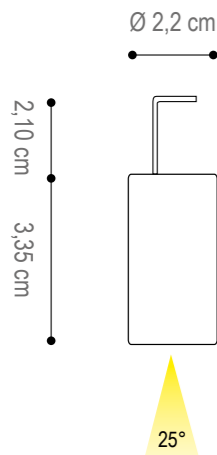

FINITURA
FINISHES

- GRIGIO VESUVIO ANTHRACITE
- ARGILLA CLAY
- BIANCO INTONACO/WHITE
- NERO CARAVAGGIO BLACK
- MOKA MOCHA
- CROMO/CHROME
- ORO CALIFORNIA/GOLD
- ARAMEN COPPER
- ARGENTO COMETA/SILVER COMET
- OTTONE VENEZIANO BRASS
- TITANIO/TITANIUM
- BRONZO RIACI/RIACI BRONZE
- VERDE COSTA/GREEN COAST
- TERRA SENESE SENESE EARTH

DRIVER NON INCLUSO

CODICE 2700K CODE 2700K	CODICE 3000K CODE 3000K	CODICE 4000K CODE 4000K
22C70024	22C80024	22C90024
22C70124	22C80124	22C90124
22C70324	22C80324	22C90324
22C70424	22C80424	22C90424
22C70524	22C80524	22C90524
22C70824	22C80824	22C90824
22C70924	22C80924	22C90924
22C71024	22C81024	22C91024
22C71224	22C81224	22C91224
22C71324	22C81324	22C91324
22C71424	22C81424	22C91424
22C71524	22C81524	22C91524
22C71624	22C81624	22C91624
22C71724	22C81724	22C91724

DATI TECNICI
TECHNICAL DATA

Flux Tot: 180-190-200lm
Output: 112 lm/W
CCT: 2700-3000-4000K
CRI: 90
Power Tot: 1.7W / 700 mA
Fascio: 35°

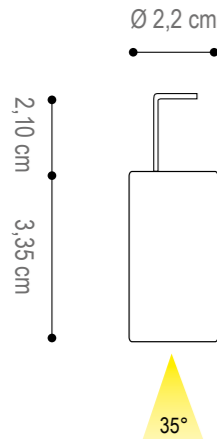

FINITURA
FINISHES

- GRIGIO VESUVIO ANTHRACITE
- ARGILLA CLAY
- BIANCO INTONACO/WHITE
- NERO CARAVAGGIO BLACK
- MOKA MOCHA
- CROMO/CHROME
- ORO CALIFORNIA/GOLD
- ARAMEN COPPER
- ARGENTO COMETA/SILVER COMET
- OTTONE VENEZIANO BRASS
- TITANIO/TITANIUM
- BRONZO RIACI/RIACI BRONZE
- VERDE COSTA/GREEN COAST
- TERRA SENESE SENESE EARTH

DRIVER NON INCLUSO

CODICE 2700K CODE 2700K	CODICE 3000K CODE 3000K	CODICE 4000K CODE 4000K
22C70036	22C80036	22C90036
22C70136	22C80136	22C90136
22C70336	22C80336	22C90336
22C70436	22C80436	22C90436
22C70536	22C80536	22C90536
22C70836	22C80836	22C90836
22C70936	22C80936	22C90936
22C71036	22C81036	22C91036
22C71236	22C81236	22C91236
22C71336	22C81336	22C91336
22C71436	22C81436	22C91436
22C71536	22C81536	22C91536
22C71636	22C81636	22C91636
22C71736	22C81736	22C91736



spigolo 23

spot integrato Irid 33

integrated spot Irid 33

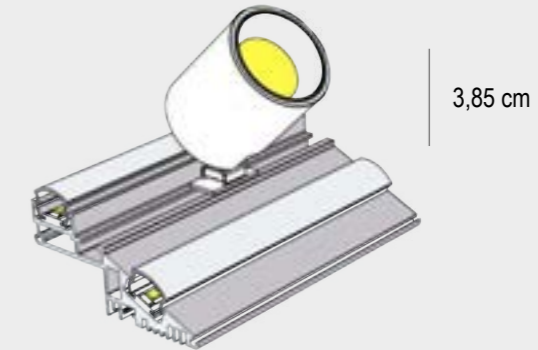

DRIVER NON INCLUSO

DATI TECNICI
TECHNICAL DATA

Flux Tot: 475-500-525 lm
Output: 100 lm/W
CCT: 2700-3000-4000K
CRI: 90
Power Tot: 5.0W / 700 mA
Fascio: 25°

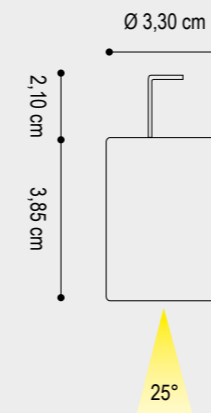

FINITURA
FINISHES

- GRIGIO VESUVIO ANTHRACITE
- ARGILLA CLAY
- BIANCO INTONACO/WHITE
- NERO CARAVAGGIO BLACK
- MOKA MOCHA
- CROMO/CHROME
- ORO CALIFORNIA/GOLD
- ARAMEN COPPER
- ARGENTO COMETA/SILVER COMET
- OTTONE VENEZIANO BRASS
- TITANIO/TITANIUM
- BRONZO RIACI/RIACI BRONZE
- VERDE COSTA/GREEN COAST
- TERRA SENESE SENESE EARTH

DRIVER NON INCLUSO

CODICE 2700K CODE 2700K	CODICE 3000K CODE 3000K	CODICE 4000K CODE 4000K
33CA0024	33CB0024	33CC0024
33CA0124	33CB0124	33CC0124
33CA0324	33CB0324	33CC0324
33CA0424	33CB0424	33CC0424
33CA0524	33CB0524	33CC0524
33CA0824	33CB0824	33CC0824
33CA0924	33CB0924	33CC0924
33CA1024	33CB1024	33CC1024
33CA1224	33CB1224	33CC1224
33CA1324	33CB1324	33CC1324
33CA1424	33CB1424	33CC1424
33CA1524	33CB1524	33CC1524
33CA1624	33CB1624	33CC1624
33CA1724	33CB1724	33CC1724

DATI TECNICI
TECHNICAL DATA

Flux Tot: 475-500-525 lm
Output: 95 lm/W
CCT: 2700-3000-4000K
CRI: 90
Power Tot: 5.0W / 700 mA
Fascio: 35°

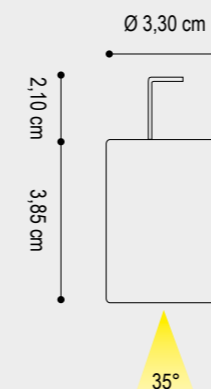

FINITURA
FINISHES

- GRIGIO VESUVIO ANTHRACITE
- ARGILLA CLAY
- BIANCO INTONACO/WHITE
- NERO CARAVAGGIO BLACK
- MOKA MOCHA
- CROMO/CHROME
- ORO CALIFORNIA/GOLD
- ARAMEN COPPER
- ARGENTO COMETA/SILVER COMET
- OTTONE VENEZIANO BRASS
- TITANIO/TITANIUM
- BRONZO RIACI/RIACI BRONZE
- VERDE COSTA/GREEN COAST
- TERRA SENESE SENESE EARTH

DRIVER NON INCLUSO

CODICE 2700K CODE 2700K	CODICE 3000K CODE 3000K	CODICE 4000K CODE 4000K
33CA0036	33CB0036	33CC0036
33CA0136	33CB0136	33CC0136
33CA0336	33CB0336	33CC0336
33CA0436	33CB0436	33CC0436
33CA0536	33CB0536	33CC0536
33CA0836	33CB0836	33CC0836
33CA0936	33CB0936	33CC0936
33CA1036	33CB1036	33CC1036
33CA1236	33CB1236	33CC1236
33CA1336	33CB1336	33CC1336
33CA1436	33CB1436	33CC1436
33CA1536	33CB1536	33CC1536
33CA1636	33CB1636	33CC1636
33CA1736	33CB1736	33CC1736

“profilo in alluminio estruso che scompare nella muratura”

I tagli di luce LED permettono di creare effetti di luce o di illuminare ambienti in modi del tutto nuovi utilizzando pareti e soffitti. T24 è un profilo in alluminio estruso che scompare nella muratura lasciando a vista solo il diffusore. Facile da installare e progettato con i migliori sistemi ottici atti a garantire la perfetta illuminazione degli spazi.

The LED light cuts allow you to create lighting effects or to illuminate environments in completely new ways using walls and ceilings. T24 is an extruded aluminum profile that disappears into the masonry leaving only the diffuser visible. Easy to install and designed with the best optical systems to ensure perfect lighting of spaces.



t23 - t24 - m24

t23 - t24 - m24

configurazioni

configurations

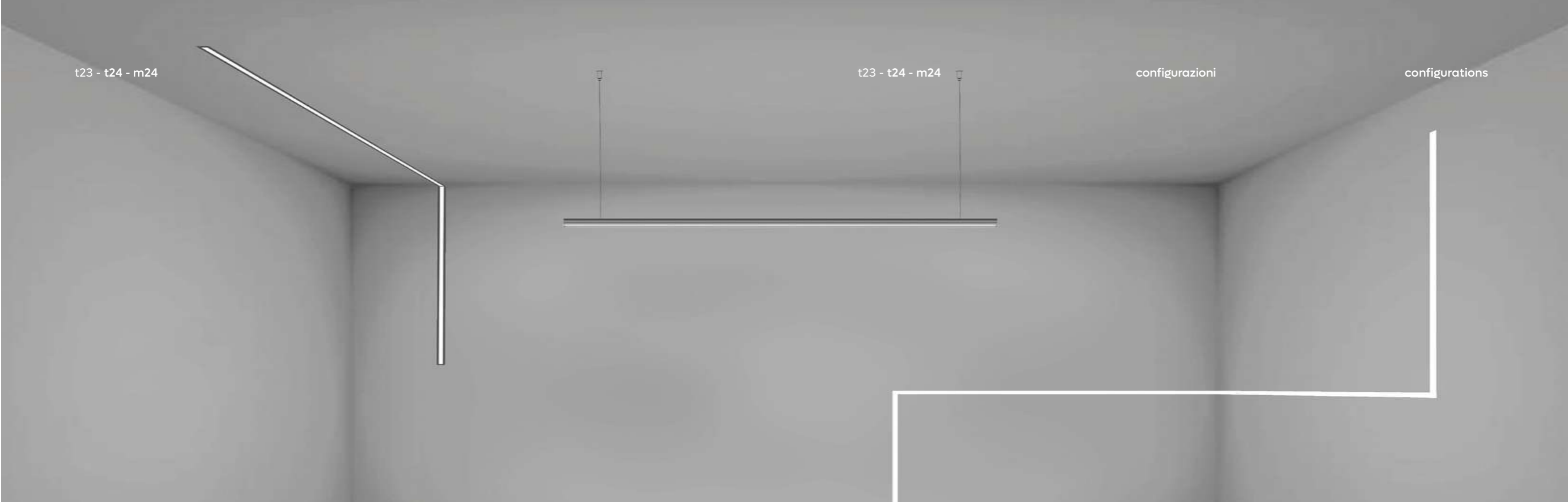

ATTENZIONE! GLI ACCESSORI PER L'INSTALLAZIONE A INCASSO SONO STATI DIMENSIONATI PER UN PANNELLO STANDARD IN CARTONGESSO DI SPESSORE 12,5

mm WARNING! THE BUILT-IN INSTALLATION ACCESSORIES HAVE BEEN DIMENSIONED FOR A STANDARD PLASTERBOARD PANEL OF 12.5 mm THICKNESS

t24

INSTALLAZIONE A SOSPENSIONE
SUSPENSION

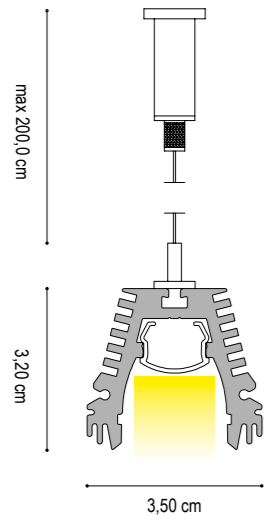

INSTALLAZIONE CON CLIP IN POLICARBONATO
INSTALLATION WITH POLYCARBONATE CLIP

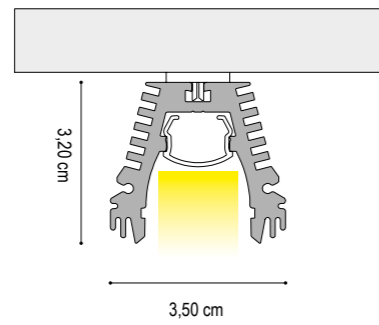

INSTALLAZIONE CON STAFFA MAGNETICA
SU SUPERFICIE METALLICA
INSTALLATION WITH MAGNET ON METAL SURFACE

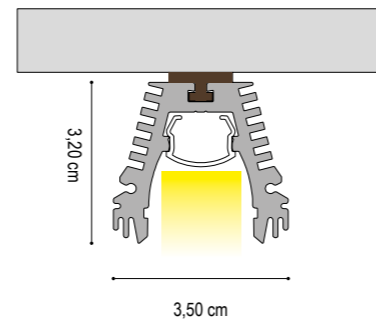

INSTALLAZIONE CON STAFFA PER INCASSO
INSTALLATION WITH BUILT-IN BRACKET

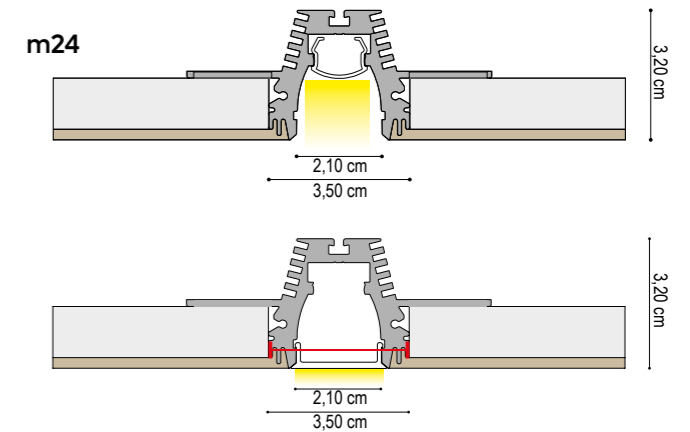
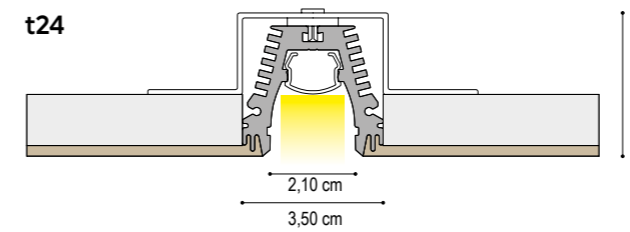

INSTALLAZIONE AD INCASSO
LARGHEZZA TAGLIO L=3,45cm
RECESSED INSTALLATION
CUTTING WIDTH L=3,45cm

t23

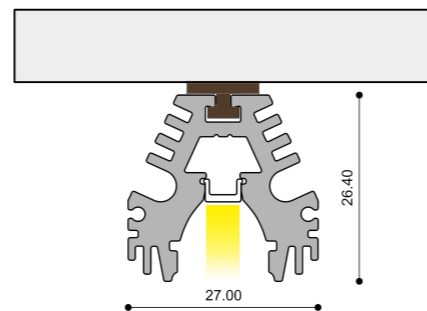
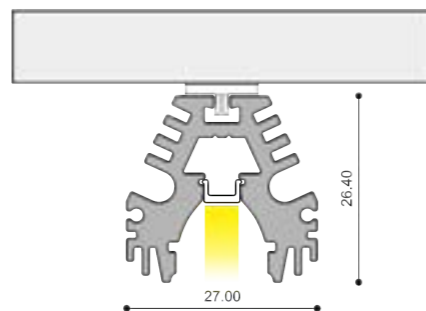
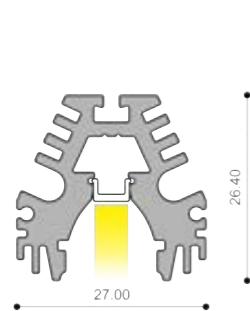

t23

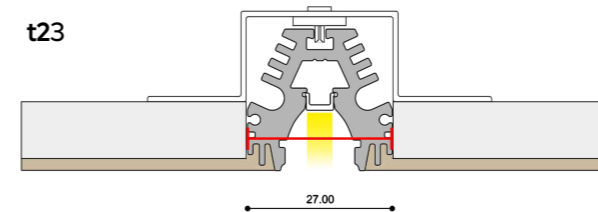

INSTALLAZIONE AD INCASSO
LARGHEZZA TAGLIO L=3,45cm
RECESSED INSTALLATION
CUTTING WIDTH L=3,45cm

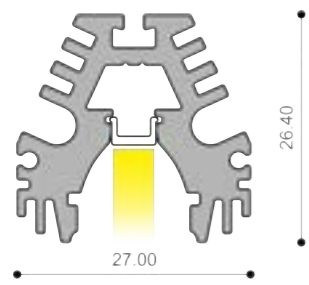

DATI TECNICI
TECHNICAL DATA

	1 cm	1 cm	1 cm
Nominal LED Flux:	1800 lm/m	1900 lm/m	1990 lm/m
Flux Tot:	1420 lm/m	1520 lm/m	1430 lm/m
Output:	150 lm/W	158 lm/W	166 lm/W
CCT:	2700 K	3000 K	4000 K
CRI:	>90	>90	>90
Power Tot:	12.0W/m	12.0W/m	12.0W/m
Weight:	0.20 Kg/m	0.20 Kg/m	0.20 Kg/m
	Alluminio/aluminum	Cover: Opale/opal	Cover: Prismaticata/prismatic
DRIVER NON INCLUSO / NOT INCLUDED			

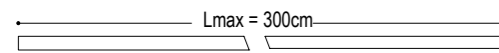

FINITURA STRUTTURA FINISHES	DIFFUSORE DIFFUSER	1 cm - 2700K	1 cm - 3000K	1 cm - 4000K
		CODICE CODE	CODICE CODE	CODICE CODE
BIANCO INTONACO/WHITE	OPALE/OPAL	2354030001	2355030001	2356030001
NERO CARAVAGGIO BLACK		2354040001	2355040001	2356040001
ALLUMINIO NATURALE/ALUMINUM		2354060001	2355060001	2356060001
ORO CALIFORNIA/GOLD		2354090001	2355090001	2356090001
ARAMEN / COPPER		2354100001	2355100001	2356100001

TIPOLOGIE INSTALLAZIONE / TYPES OF INSTALLATION: SOSPENSIONE / SUSPENSION, SOFFITTO / CEILING, INCASSO / RECESSED

TESTATE DI CHIUSURA / DEAD ENDS

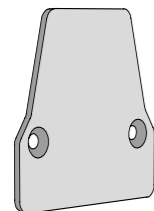

FINITURA STRUTTURA FINISHES	CODICE CODE
BIANCO INTONACO/WHITE	230403
NERO CARAVAGGIO BLACK	230404
ALLUMINIO NATURALE/ALUMINUM	230406
ORO CALIFORNIA/GOLD	230409
ARAMEN / COPPER	230410

Il codice contiene 1 testata di chiusura/The code contains 1 closing warheads

STAFFA DI FISSAGGIO A DOPPIO ATTACCO / DOUBLE MOUNTING CLIP **CALAMITA / MAGNET**

FINITURA FINISHES	CODICE CODE	PORTATA RANGE
SUPERFICI PIANE 2mm EVEN SURFACE 2mm	1020500005	1 Kg
SUPERFICI IRREGOLARI 3,9 mm UNEVEN SURFACE 3.9 mm	1020500006	2 Kg

Accessorio per fissaggio a plafone/superficie. Quantità raccomandata: 1 pz ogni 50 cm di modello.

Ceiling/surface mounting accessory. Recommended quantity: 1 pc every 50 cm of model.

Quantità raccomandata: 1 pz ogni 25 cm di modello.

Recommended quantity: 1 pc every 25 cm of model.

KIT DI SOSPENSIONE / SUSPENSION KIT

DATI TECNICI
TECHNICAL DATA

ARTICOLI INCLUSI NEL CODICE
ARTICLES INCLUDED IN THE CODE

Cavo in acciaio 2,00m con puntalino
2.00m steel cable with tip
Boccola cromata con regolazione millimetrica
Chrome bush with millimeter adjustment
Archetto in alluminio per sospensione
Aluminum arch for suspension

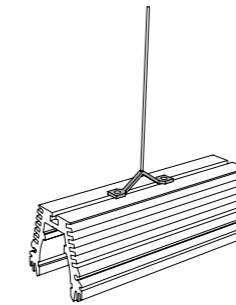

FINITURA STRUTTURA
FINISHES

CODICE
CODE

PREZZO

BIANCO INTONACO/WHITE	1040503004	
NERO CARAVAGGIO BLACK	1040504004	
ALLUMINIO NATURALE/ALUMINUM	1040506004	
ORO CALIFORNIA/GOLD	1040509004	
	104051004	

STAFFA DI FISSAGGIO A CARTONGESSO PER T24 / PLASTERBOARD FIXING BRACKET FOR T24

Accessorio che consente l'incasso nel profilo.
Accessory that allows the collection of the model.

Nel codice sono comprese le viti per il fissaggio del modello alla staffa. The code includes screws for fixing the model to the bracket.

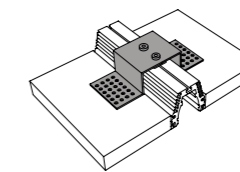

FINITURA
FINISHES

CODICE
CODE

ALLUMINIO NATURALE/ALUMINUM	230502
-----------------------------	--------

GIUNTI / JOINTS

GIUNTO LINEA CONTINUA / STRAIGHT JOINT

Accessorio per giunzioni meccaniche lineari
Accessory for linear mechanical joints

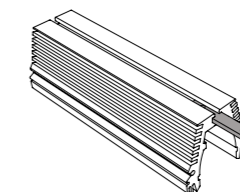

FINITURA
FINISHES

CODICE
CODE

ALLUMINIO NATURALE/ALUMINUM	1010500006
-----------------------------	------------

GIUNTO 90° ORIZZONTALE / HORIZONTAL JOINT 90°

Accessorio per giunzioni meccaniche con angolo 90°
Accessory for linear mechanical joints with 90° angle

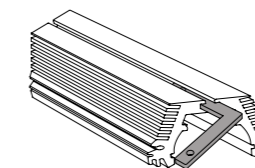

ALLUMINIO NATURALE/ALUMINUM	1010500005
-----------------------------	------------

GIUNTO 90° VERTICALE / VERTICAL JOINT 90°

Accessorio per giunzioni meccaniche con angolo 90°
Accessory for linear mechanical joints with 90° angle

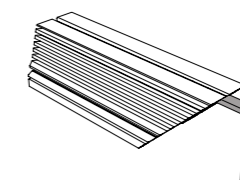

ALLUMINIO NATURALE/ALUMINUM	1010500007
-----------------------------	------------

Nel codice sono compresi i grani di fissaggio del giunto / The code includes the grains for fixing the joint.

LAVORAZIONI / PROCESSING PAG. 53

t24 **led integrato** **integrated led**

TIPOLOGIE INSTALLAZIONE / TYPES OF INSTALLATION
 SOSPENSIONE / SUSPENSION
 SOFFITTO / CEILING
 INCASSO / RECESSED

DRIVER NON INCLUSO / NOT INCLUDED

LUNGHEZZA CAVO ALIMENTAZIONE : 50 cm
 ALIMENTATION CABLE LENGTH : 50 cm

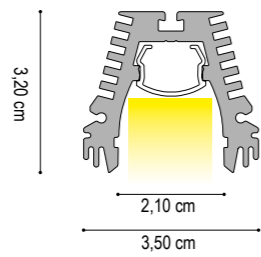

DATI TECNICI
TECHNICAL DATA

COVER RECESSA / RECESSED DIFFUSER

	1 cm
Nominal LED Flux:	3000 lm/m
Flux Tot:	2460 lm/m
Output:	125 lm/W
CCT:	3000 K
CRI:	>95
Power Tot:	24.0W/m
Weight:	1.20 Kg/m

Alluminio/aluminium
 Cover: Opale/opal - Eclissi/eclipse

Lmax = 300cm

FINITURA STRUTTURA FINISHES	DIFFUSORE DIFFUSER	1 cm - 2700K	1 cm - 3000K	1 cm - 4000K
		CODICE CODE	CODICE CODE	CODICE CODE
BIANCO INTONACO/WHITE	ECLISSI/ECLIPSE	24H6036001	24H7036001	24H8036001
NERO CARAVAGGIO BLACK		24H6046001	24H7046001	24H8046001
ALLUMINIO NATURALE/ALUMINUM		24H6066001	24H7066001	24H8066001
ORO CALIFORNIA/GOLD		24H6096001	24H7096001	24H8096001
ARAMEN / COPPER		24H6106001	24H7106001	24H8106001
BIANCO INTONACO/WHITE	OPALE/OPAL	24H6030001	24H7030001	24H8030001
NERO CARAVAGGIO BLACK		24H6040001	24H7040001	24H8040001
ALLUMINIO NATURALE/ALUMINUM		24H6060001	24H7060001	24H8060001
ORO CALIFORNIA/GOLD		24H6090001	24H7090001	24H8090001
ARAMEN / COPPER		24H6100001	24H7100001	24H8100001

TIPOLOGIE INSTALLAZIONE / TYPES OF INSTALLATION
 SOSPENSIONE / SUSPENSION
 SOFFITTO / CEILING
 INCASSO / RECESSED

DRIVER NON INCLUSO / NOT INCLUDED

LUNGHEZZA CAVO ALIMENTAZIONE : 50 cm
 ALIMENTATION CABLE LENGTH : 50 cm

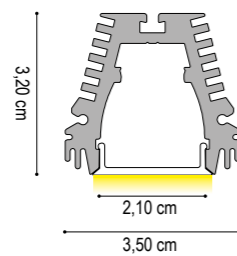

DATI TECNICI
TECHNICAL DATA

COVER ESTERNA / EXTERNAL DIFFUSER

	1 cm
Nominal LED Flux:	3000 lm/m
Flux Tot:	2460 lm/m
Output:	140 lm/W
CCT:	3000 K
CRI:	>95
Power Tot:	24.0W/m
Weight:	1.20 Kg/m

Alluminio/aluminium
 Cover: Opale/opal

Lmax = 300cm

FINITURA STRUTTURA FINISHES	DIFFUSORE DIFFUSER	1 cm - 2700K	1 cm - 3000K	1 cm - 4000K
		CODICE CODE	CODICE CODE	CODICE CODE
BIANCO INTONACO/WHITE	OPALE/OPAL	24H6030011	24H7030011	24H8030011
ALLUMINIO NATURALE/ALUMINUM		24H6060011	24H7060011	24H8060011

m24 **led integrato** **integrated led**



DATI TECNICI
TECHNICAL DATA

COVER RECESSA / RECESSED DIFFUSER

	1 cm
Nominal LED Flux:	3000 lm/m
Flux Tot:	2460 lm/m
Output:	125 lm/W
CCT:	3000 K
CRI:	>95
Power Tot:	24.0W/m
Weight:	1.20 Kg/m

Alluminio/aluminium
 Cover: Opale/opal - Eclissi/eclipse

DRIVER NON INCLUSO / NOT INCLUDED

LUNGHEZZA CAVO ALIMENTAZIONE : 50 cm
 ALIMENTATION CABLE LENGTH : 50 cm

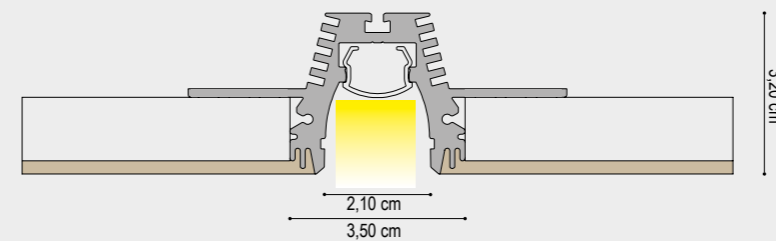

FINITURA STRUTTURA FINISHES	DIFFUSORE DIFFUSER	1 cm - 2700K	1 cm - 3000K	1 cm - 4000K
		CODICE CODE	CODICE CODE	CODICE CODE
BIANCO INTONACO/WHITE	ECLISSI/ECLIPSE	24H603C001	24H703C001	24H803C001
NERO CARAVAGGIO BLACK		24H604C001	24H704C001	24H804C001
ALLUMINIO NATURALE/ALUMINUM		24H606C001	24H706C001	24H806C001
ORO CALIFORNIA/GOLD		24H609C001	24H709C001	24H809C001
BIANCO INTONACO/WHITE	OPALE/OPAL	24H603T001	24H703T001	24H803T001
NERO CARAVAGGIO BLACK		24H604T001	24H704T001	24H804T001
ALLUMINIO NATURALE/ALUMINUM		24H606T001	24H706T001	24H806T001
ORO CALIFORNIA/GOLD		24H609T001	24H709T001	24H809T001



DATI TECNICI
TECHNICAL DATA

COVER ESTERNA / EXTERNAL DIFFUSER

	1 cm
Nominal LED Flux:	3000 lm/m
Flux Tot:	2460 lm/m
Output:	140 lm/W
CCT:	3000 K
CRI:	>95
Power Tot:	24.0W/m
Weight:	1.20 Kg/m

Alluminio/aluminium
 Cover: Opale/opal

DRIVER NON INCLUSO / NOT INCLUDED

LUNGHEZZA CAVO ALIMENTAZIONE : 50 cm
 ALIMENTATION CABLE LENGTH : 50 cm

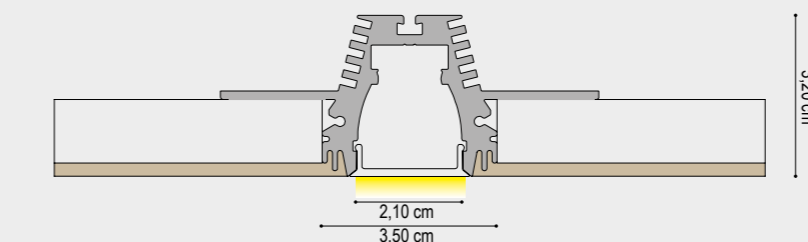

FINITURA STRUTTURA FINISHES	DIFFUSORE DIFFUSER	1 cm - 2700K	1 cm - 3000K	1 cm - 4000K
		CODICE CODE	CODICE CODE	CODICE CODE
ALLUMINIO NATURALE/ALUMINUM	OPALE/OPAL	24H606T011	24H706T011	24H806T011

NEL CODICE PROFILO È INCLUSA LA COVER POSA IN OPERA (COVER MONOUSO PER PROTEGGERE IL PROFILO DURANTE LE FASI DI INSTALLAZIONE)

THE COVER INSTALLED IS INCLUDED IN THE PROFILE CODE (DISPOSABLE COVER TO PROTECT THE PROFILE DURING THE INSTALLATION PHASES)

t24

COVER RECESSA / RECESSED DIFFUSER

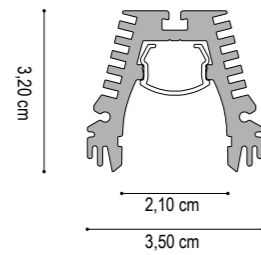

COVER ESTERNA / EXTERNAL DIFFUSER

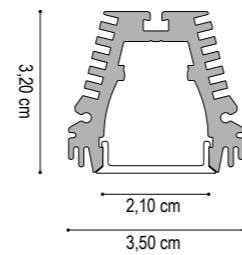

LED NON INTEGRATO / NOT INTEGRATED LED

		1 cm	200 cm	300 cm							
FINITURA STRUTTURA FINISHES	DIFFUSORE DIFFUSER	CODICE CODE	CODICE CODE	CODICE CODE							
		<table border="1"> <tr><td>BIANCO INTONACO/WHITE</td></tr> <tr><td>NERO CARAVAGGIO/BLACK</td></tr> </table>	BIANCO INTONACO/WHITE	NERO CARAVAGGIO/BLACK	<table border="1"> <tr><td>24CE030001</td></tr> <tr><td>24CE040001</td></tr> </table>	24CE030001	24CE040001	<table border="1"> <tr><td>24CE030200</td></tr> <tr><td>24CE040200</td></tr> </table>	24CE030200	24CE040200	<table border="1"> <tr><td>24CE030300</td></tr> <tr><td>24CE040300</td></tr> </table>
BIANCO INTONACO/WHITE											
NERO CARAVAGGIO/BLACK											
24CE030001											
24CE040001											
24CE030200											
24CE040200											
24CE030300											
24CE040300											
	<table border="1"> <tr><td>ECLISSI/ECLIPSE</td></tr> </table>	ECLISSI/ECLIPSE									
ECLISSI/ECLIPSE											
	<table border="1"> <tr><td>OPALE/OPAL</td></tr> </table>	OPALE/OPAL	<table border="1"> <tr><td>24CR030001</td></tr> <tr><td>24CR040001</td></tr> </table>	24CR030001	24CR040001	<table border="1"> <tr><td>24CR030200</td></tr> <tr><td>24CR040200</td></tr> </table>	24CR030200	24CR040200	<table border="1"> <tr><td>24CR030300</td></tr> <tr><td>24CR040300</td></tr> </table>	24CR030300	24CR040300
OPALE/OPAL											
24CR030001											
24CR040001											
24CR030200											
24CR040200											
24CR030300											
24CR040300											

COVER ESTERNA / EXTERNAL DIFFUSER

		1 cm	200 cm	300 cm							
FINITURA STRUTTURA FINISHES	DIFFUSORE DIFFUSER	CODICE CODE	CODICE CODE	CODICE CODE							
		<table border="1"> <tr><td>BIANCO INTONACO/WHITE</td></tr> <tr><td>ALLUMINIO NATURALE/ALUMINUM</td></tr> </table>	BIANCO INTONACO/WHITE	ALLUMINIO NATURALE/ALUMINUM	<table border="1"> <tr><td>24CP030001</td></tr> <tr><td>24CP060001</td></tr> </table>	24CP030001	24CP060001	<table border="1"> <tr><td>24CP030200</td></tr> <tr><td>24CP060200</td></tr> </table>	24CP030200	24CP060200	<table border="1"> <tr><td>24CP030300</td></tr> <tr><td>24CP060300</td></tr> </table>
BIANCO INTONACO/WHITE											
ALLUMINIO NATURALE/ALUMINUM											
24CP030001											
24CP060001											
24CP030200											
24CP060200											
24CP030300											
24CP060300											
	<table border="1"> <tr><td>OPALE/OPAL</td></tr> </table>	OPALE/OPAL									
OPALE/OPAL											

m24

COVER RECESSA / RECESSED DIFFUSER

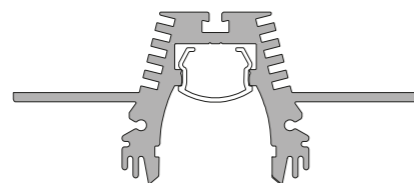

COVER ESTERNA / EXTERNAL DIFFUSER

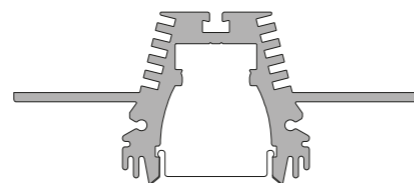

LED NON INTEGRATO / NOT INTEGRATED LED

		1 cm	200 cm	300 cm											
FINITURA STRUTTURA FINISHES	DIFFUSORE DIFFUSER	CODICE CODE	CODICE CODE	CODICE CODE											
		<table border="1"> <tr><td>BIANCO INTONACO/WHITE</td></tr> <tr><td>NERO CARAVAGGIO/BLACK</td></tr> <tr><td>ALLUMINIO NATURALE/ALUMINUM</td></tr> </table>	BIANCO INTONACO/WHITE	NERO CARAVAGGIO/BLACK	ALLUMINIO NATURALE/ALUMINUM	<table border="1"> <tr><td>24CE03C001</td></tr> <tr><td>24CE04C001</td></tr> <tr><td>24CE06C001</td></tr> </table>	24CE03C001	24CE04C001	24CE06C001	<table border="1"> <tr><td>24CE03C200</td></tr> <tr><td>24CE04C200</td></tr> <tr><td>24CE06C200</td></tr> </table>	24CE03C200	24CE04C200	24CE06C200	<table border="1"> <tr><td>24CE03C300</td></tr> <tr><td>24CE04C300</td></tr> <tr><td>24CE06C300</td></tr> </table>	24CE03C300
BIANCO INTONACO/WHITE															
NERO CARAVAGGIO/BLACK															
ALLUMINIO NATURALE/ALUMINUM															
24CE03C001															
24CE04C001															
24CE06C001															
24CE03C200															
24CE04C200															
24CE06C200															
24CE03C300															
24CE04C300															
24CE06C300															
	<table border="1"> <tr><td>ECLISSI/ECLIPSE</td></tr> </table>	ECLISSI/ECLIPSE													
ECLISSI/ECLIPSE															
	<table border="1"> <tr><td>OPALE/OPAL</td></tr> </table>	OPALE/OPAL	<table border="1"> <tr><td>24CR03T001</td></tr> <tr><td>24CR04T001</td></tr> <tr><td>24CR06T001</td></tr> </table>	24CR03T001	24CR04T001	24CR06T001	<table border="1"> <tr><td>24CR03T200</td></tr> <tr><td>24CR04T200</td></tr> <tr><td>24CR06T200</td></tr> </table>	24CR03T200	24CR04T200	24CR06T200	<table border="1"> <tr><td>24CR03T300</td></tr> <tr><td>24CR04T300</td></tr> <tr><td>24CR06T300</td></tr> </table>	24CR03T300	24CR04T300	24CR06T300	
OPALE/OPAL															
24CR03T001															
24CR04T001															
24CR06T001															
24CR03T200															
24CR04T200															
24CR06T200															
24CR03T300															
24CR04T300															
24CR06T300															

COVER ESTERNA / EXTERNAL DIFFUSER

		1 cm	200 cm	300 cm							
FINITURA STRUTTURA FINISHES	DIFFUSORE DIFFUSER	CODICE CODE	CODICE CODE	CODICE CODE							
		<table border="1"> <tr><td>BIANCO INTONACO/WHITE</td></tr> <tr><td>ALLUMINIO NATURALE/ALUMINUM</td></tr> </table>	BIANCO INTONACO/WHITE	ALLUMINIO NATURALE/ALUMINUM	<table border="1"> <tr><td>24CP03T011</td></tr> <tr><td>24CP06T011</td></tr> </table>	24CP03T011	24CP06T011	<table border="1"> <tr><td>24CP03T210</td></tr> <tr><td>24CP06T210</td></tr> </table>	24CP03T210	24CP06T210	<table border="1"> <tr><td>24CP03T310</td></tr> <tr><td>24CP06T310</td></tr> </table>
BIANCO INTONACO/WHITE											
ALLUMINIO NATURALE/ALUMINUM											
24CP03T011											
24CP06T011											
24CP03T210											
24CP06T210											
24CP03T310											
24CP06T310											
	<table border="1"> <tr><td>OPALE/OPAL</td></tr> </table>	OPALE/OPAL									
OPALE/OPAL											

t24

accessori

accessories

TESTATE DI CHIUSURA / DEAD ENDS

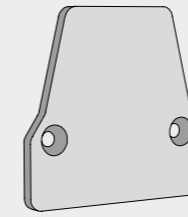

FINITURA STRUTTURA
FINISHES

BIANCO INTONACO/WHITE
NERO CARAVAGGIO/BLACK
ALLUMINIO NATURALE/ALUMINUM
ORO CALIFORNIA/GOLD
ARAMEN / COPPER

CODICE
CODE

240403
240404
240406
240409
240410

Il codice contiene 1 testata di chiusura
The code contains 1 closing warheads

GIUNTI / JOINTS

GIUNTO LINEA CONTINUA / STRAIGHT JOINT

Accessorio per giunzioni meccaniche lineari
Accessory for linear mechanical joints

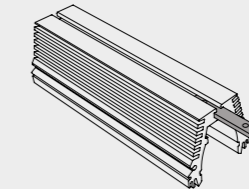

FINITURA
FINISHES

ALLUMINIO NATURALE/ALUMINUM

CODICE
CODE

1010500006

PREZZO
PRICE

GIUNTO 90° ORIZZONTALE / HORIZONTAL JOINT 90°

Accessorio per giunzioni meccaniche con angolo 90°
Accessory for linear mechanical joints with 90° angle

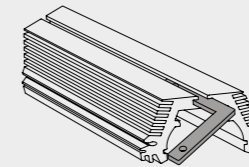

FINITURA
FINISHES

ALLUMINIO NATURALE/ALUMINUM

CODICE
CODE

1010500005

GIUNTO 90° VERTICALE / VERTICAL JOINT 90°

Accessorio per giunzioni meccaniche con angolo 90°
Accessory for linear mechanical joints with 90° angle

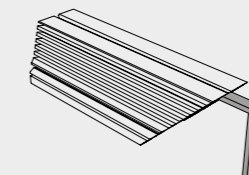

FINITURA
FINISHES

ALLUMINIO NATURALE/ALUMINUM

CODICE
CODE

1010500007

Nel codice sono compresi i grani di fissaggio del giunto / The code includes the grains for fixing the joint.

STAFFA DI FISSAGGIO A DOPPIO ATTACCO / DOUBLE MOUNTING CLIP CALAMITA / MAGNET



FINITURA
FINISHES

SUPERFICI PIANE 2mm EVEN SURFACE 2mm

CODICE
CODE

1020500005

CODICE
CODE

1020500010

PORTATA
RANGE

1 Kg



SUPERFICI IRREGOLARI 3,9 mm UNEVEN SURFACE 3,9 mm
--

1020500006

1020500210

2 Kg

Accessorio per fissaggio a plafone/superficie. Quantità raccomandata: 1 pz ogni 50 cm di modello.

Ceiling/surface mounting accessory. Recommended quantity 1 pc every 50 cm of model.

Quantità raccomandata: 1 pz ogni 25 cm di modello.

Recommended quantity: 1 pc every 25 cm of model.

KIT DI SOSPENSIONE / SUSPENSION KIT

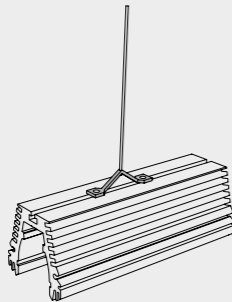
DATI TECNICI TECHNICAL DATA	FINITURA STRUTTURA FINISHES	CODICE CODE
<p>ARTICOLI INCLUSI NEL CODICE ARTICLES INCLUDED IN THE CODE</p> <p>Cavo in acciaio 2,00m con puntalino 2.00m steel cable with tip Boccola cromata con regolazione millimetrica Chrome bush with millimeter adjustment Archetto in alluminio per sospensione Aluminum arch for suspension</p> 	<p>BIANCO INTONACO/WHITE</p> <p>NERO CARAVAGGIO BLACK</p> <p>ALLUMINIO NATURALE/ALUMINUM</p> <p>ORO CALIFORNIA/GOLD</p> <p>ARAMEN / COPPER</p>	<p>1040503004</p> <p>1040504004</p> <p>1040506004</p> <p>1040509004</p> <p>1040510004</p>

STAFFA DI FISSAGGIO A CARTONGESSO PER T24 / PLASTERBOARD FIXING BRACKET FOR T24

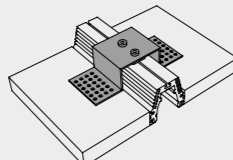
DATI TECNICI TECHNICAL DATA	FINITURA FINISHES	CODICE CODE
<p>Accessorio che consente l'incasso nel profilo. Accessory that allows the collection of the model.</p> <p>Nel codice sono comprese le viti per il fissaggio del modello alla staffa. The code includes screws for fixing the model to the bracket.</p> 	<p>ALLUMINIO NATURALE/ALUMINUM</p>	<p>240502</p>

LAVORAZIONI / PROCESSING

DATI TECNICI TECHNICAL DATA	CODICE CODE
<p>TAGLIO 90° ORIZZONTALE (PER ANGOLI FORMATI DA DUE PROFILI) HORIZONTAL 90 ° CUT (FOR CORNERS MADE OF TWO PROFILES)</p>	190X
<p>TAGLIO 90° VERTICALE (PER ANGOLI FORMATI DA DUE PROFILI) VERTICAL 90 ° CUT (FOR CORNERS MADE OF TWO PROFILES)</p>	190Y
<p>TAGLIO ANGOLARE CUSTOM (PER ANGOLI FORMATI DA DUE PROFILI) CUSTOM CORNER CUT (FOR CORNERS MADE OF TWO PROFILES)</p>	190N
<p>FORO / HOLE</p>	100F
<p>ASOLA / SLOT NON STANDARD</p>	100N
<p>CABLAGGIO CE</p>	2401



“pensati allo scopo di illuminare in modo deciso e netto gli angoli chiusi e aperti”

o Le società moderne tendono a trasformare sempre di più i luoghi in ambienti confortevoli siano essi dedicati al lavoro o al relax allo shopping. La luce ha un ruolo fondamentale per creare scenografie che trasmettono benessere, calore ed emozioni, essa influenza positivamente la sfera emozionale delle persone che li vivono. IN e OUT sono stati pensati allo scopo di illuminare in modo deciso e netto gli angoli chiusi e aperti, molto presenti nel costruito, ma spesso non bene illuminati. Le due soluzioni disegnate per consentire ai progettisti di creare negli ambienti linee luminose in grado di evidenziarne gli aspetti, rendendoli più visibili eleganti e dall'aspetto futuristico.

Modern societies tend to increasingly transform places into comfortable environments whether they are dedicated to work, relaxation or shopping. Light plays a fundamental role in creating scenographies that transmit well-being, warmth and emotions, it positively influences the emotional sphere of the people who live them. IN and OUT - have been designed with the aim of clearly and decisively illuminating closed and open corners, very present in the building, but often not well lit. The two solutions designed to allow designers to create luminous lines in the rooms that are able to highlight their aspects, making them more visible, elegant and with a futuristic appearance.



in installazione installation

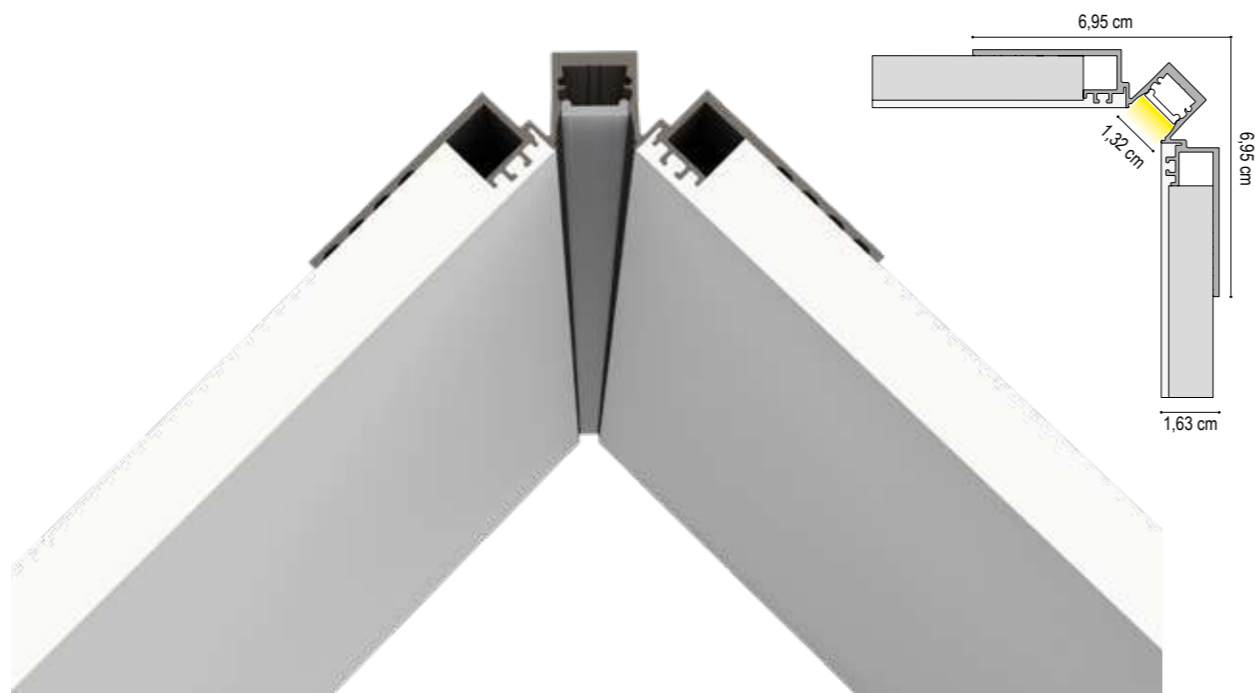

in led integrato integrated led

ATTENZIONE! IL PROFILO E' STATO DIMENSIONATO PER UN PANNELLO STANDARD IN CARTONGESSO DI SPESSORE 12,5 mm

WARNING! THE PROFILE HAS BEEN SIZED FOR A STANDARD PLASTERBOARD PANEL OF 12.5 mm THICKNESS

DRIVER NON INCLUSO / NOT INCLUDED

LUNGHEZZA CAVO ALIMENTAZIONE : 50 cm
ALIMENTATION CABLE LENGTH : 50 cm

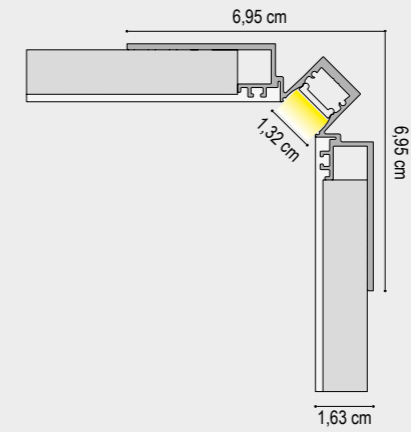

DATI TECNICI
TECHNICAL DATA

	1 cm
Nominal LED Flux:	3000 lm/m
Flux Tot:	2460 lm/m
Output:	125 lm/W
CCT:	3000 K
CRI:	>95
Power Tot:	24.0W/m
Weight:	0.50 Kg/m

Cover: Alluminio/aluminium
Opale/opal

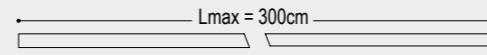

FINITURA STRUTTURA FINISHES	DIFFUSORE DIFFUSER	1 cm - 2700K	1 cm - 3000K	1 cm - 4000K
		CODICE CODE	CODICE CODE	CODICE CODE
BIANCO INTONACO/WHITE	ECLISSI/ECLIPSE	28H603C001	28H703C001	28H803C001
NERO CARAVAGGIO BLACK		28H604C001	28H704C001	28H804C001
ALLUMINIO NATURALE/ALUMINUM		28H606C001	28H706C001	28H806C001
BIANCO INTONACO/WHITE	OPALE/OPAL	28H603N001	28H703N001	28H803N001
NERO CARAVAGGIO BLACK		28H604N001	28H704N001	28H804N001
ALLUMINIO NATURALE/ALUMINUM		28H606N001	28H706N001	28H806N001
ORO CALIFORNIA/GOLD		28H609N001	28H709N001	28H809N001

out installazione installation

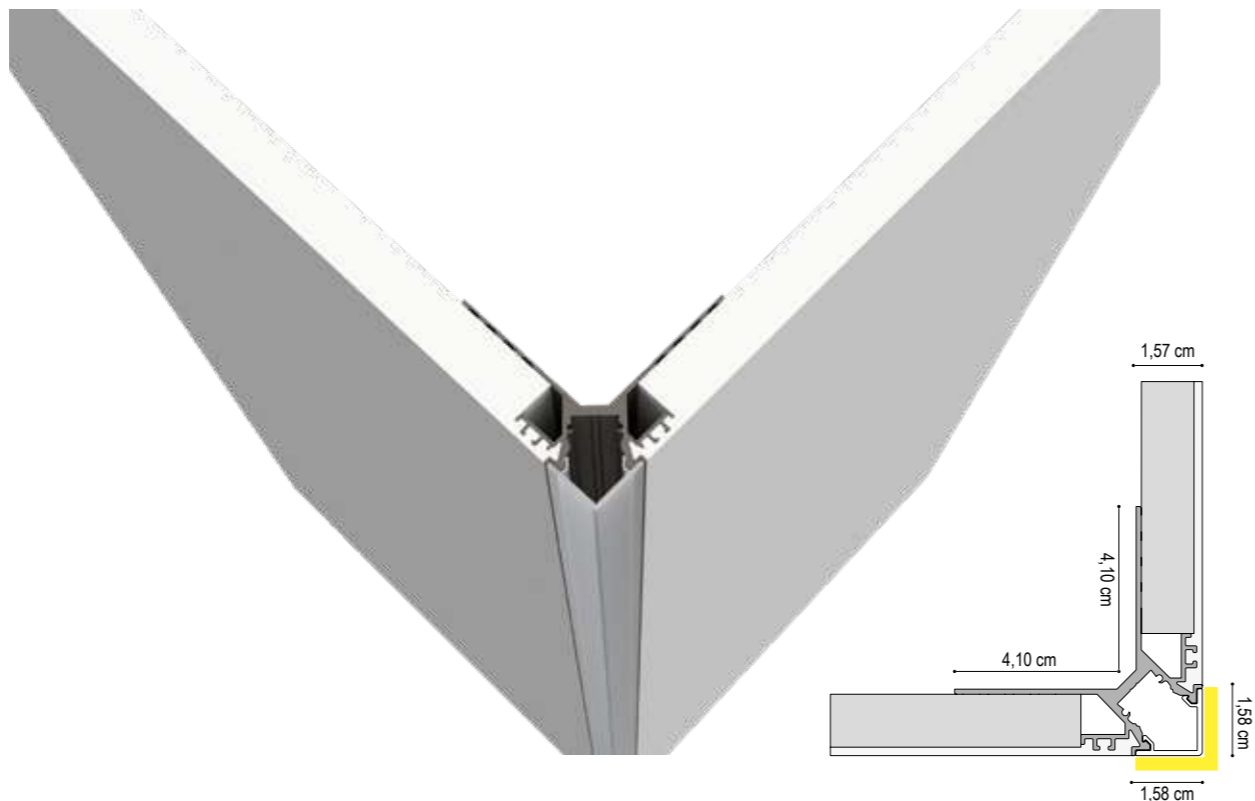

out led integrato integrated led

ATTENZIONE! IL PROFILO E' STATO DIMENSIONATO PER UN PANNELLO STANDARD IN CARTONGESSO DI SPESSORE 12,5 mm

WARNING! THE PROFILE HAS BEEN SIZED FOR A STANDARD PLASTERBOARD PANEL OF 12.5 mm THICKNESS

DRIVER NON INCLUSO / NOT INCLUDED

LUNGHEZZA CAVO ALIMENTAZIONE : 50 cm
ALIMENTATION CABLE LENGTH : 50 cm

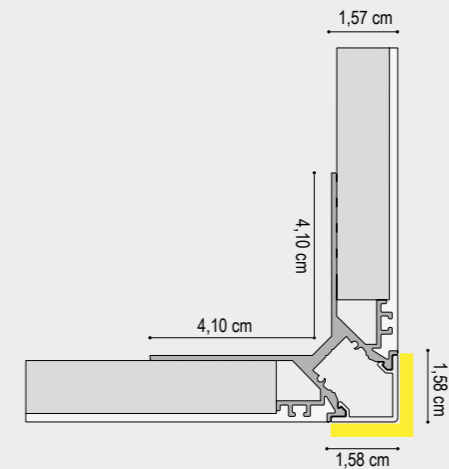

DATI TECNICI
TECHNICAL DATA

	1 cm
Nominal LED Flux:	3000 lm/m
Flux Tot:	2460 lm/m
Output:	140 lm/W
CCT:	3000 K
CRI:	>95
Power Tot:	24.0W/m
Weight:	0.50 Kg/m

Cover: Alluminio/aluminium
Opale/opal

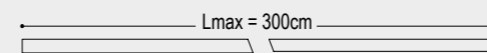

FINITURA STRUTTURA FINISHES	DIFFUSORE DIFFUSER	1 cm	1 cm	1 cm
		CODICE 2700K CODE 2700K	CODICE 3000K CODE 3000K	CODICE 4000K CODE 4000K
ALLUMINIO NATURALE/ALUMINUM	OPALE/OPAL	28H606T001	28H706T001	28H806T001



in led non integrato not integrated led

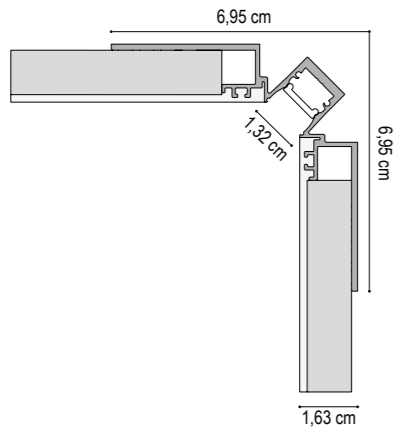

ATTENZIONE! IL PROFILO E' STATO DIMENSIONATO PER UN PANNELLO STANDARD IN CARTONGESSO DI SPESSORE 12,5 mm
 WARNING! THE PROFILE HAS BEEN SIZED FOR A STANDARD PLASTERBOARD PANEL OF 12.5 mm THICKNESS

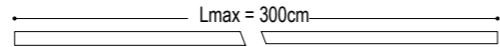

		1 cm	200 cm	300 cm
FINITURA STRUTTURA FINISHES	BIANCO INTONACO/WHITE	280303C001	280303C200	280303C300
	NERO CARAVAGGIO BLACK	280304C001	280304C200	280304C300
	ALLUMINIO NATURALE/ALUMINUM	280306C001	280306C200	280306C300
DIFFUSORE DIFFUSER	ECLISSI/ECLIPSE			
	OPALE/OPAL	280303N001	280303N200	280303N300
		280304N001	280304N200	280304N300
		280306N001	280306N200	280306N300

out led non integrato not integrated led

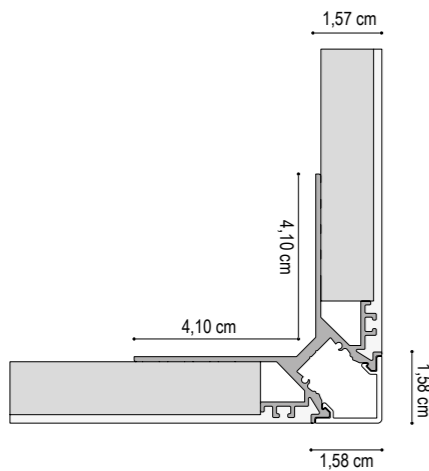

ATTENZIONE! IL PROFILO E' STATO DIMENSIONATO PER UN PANNELLO STANDARD IN CARTONGESSO DI SPESSORE 12,5 mm
 WARNING! THE PROFILE HAS BEEN SIZED FOR A STANDARD PLASTERBOARD PANEL OF 12.5 mm THICKNESS

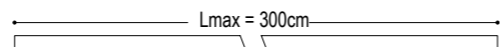

		1 cm	200 cm	300 cm
FINITURA STRUTTURA FINISHES	ALLUMINIO NATURALE/ALUMINUM	280306T001	280306T200	280306T300
	OPALE/OPAL			

in - out led integrated integrated led

LED compatibili / LED compatibility

HIGH QUALITY CRI>90 CRI>95	HIGH OUTPUT CRI>90 CRI>95	HIGH EFFICIENT CRI>90 CRI>95	HIGH INTENSITY CRI>90 CRI>95	LOW POWER CRI>90	ULTRA SLIM CRI>90 CRI>95 CRI>97	RGB	RGB WHITE	RGB TW	TUNABLE WHITE
9,6W 14,4W 19,2W	12,3W 14,4W 19,2W 20W 24W	12,3W 14,4W 19,2W 20W 24W	24W 24W (700 LED)	6W	9,6W 12W 14,4W	14W	14W	14,4W 23W	19,2W

in accessori accessories

TESTATE DI CHIUSURA / DEAD ENDS

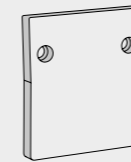

FINITURA STRUTTURA
FINISHES

BIANCO INTONACO/WHITE
NERO CARAVAGGIO BLACK
ALLUMINIO NATURALE/ALUMINUM

CODICE
CODE

280403N
280404N
280406N

Il codice contiene 1 testata di chiusura
 The code contains 1 closing warheads

out accessori accessories

TESTATE DI CHIUSURA / DEAD ENDS

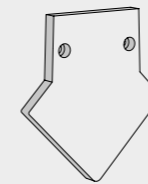

FINITURA STRUTTURA
FINISHES

BIANCO INTONACO/WHITE
NERO CARAVAGGIO BLACK
ALLUMINIO NATURALE/ALUMINUM

CODICE
CODE

280403U
280404U
280406U

Il codice contiene 1 testata di chiusura
 The code contains 1 closing warheads

LAVORAZIONI / PROCESSING

DATI TECNICI
TECHNICAL DATA



ASOLA CUSTOM / CUSTOM SLOT

CODICE
CODE

100N

FORO / HOLE

100F



CABLAGGIO - COLLAUDO - CE AL CENTIMETRO
 INSTALLATION AND TESTING LED MODULE AT CENTIMETER

2801

“luce radente, illuminazione perfetta”

Il sistema KEPLER è un profilo in alluminio estruso che consente di illuminare con luce radente le pareti degli ambienti lavorativi e abitativi. Scompare nel controsoffitto, facile da installare e progettato con i migliori sistemi ottici atti a garantire la perfetta illuminazione degli spazi. Viene proposto in due versioni: con diffusore recesso per un effetto “gola luminosa” e con diffusore esterno per una continuità visiva.

The KEPLER system is an extruded aluminum profile that allows you to illuminate the walls of working and living environments with grazing light. It disappears into the false ceiling, easy to install and designed with the best optical systems to guarantee perfect lighting of spaces. It is proposed in two versions: with recessed diffuser for a “luminous throat” effect and with external diffuser for visual continuity.

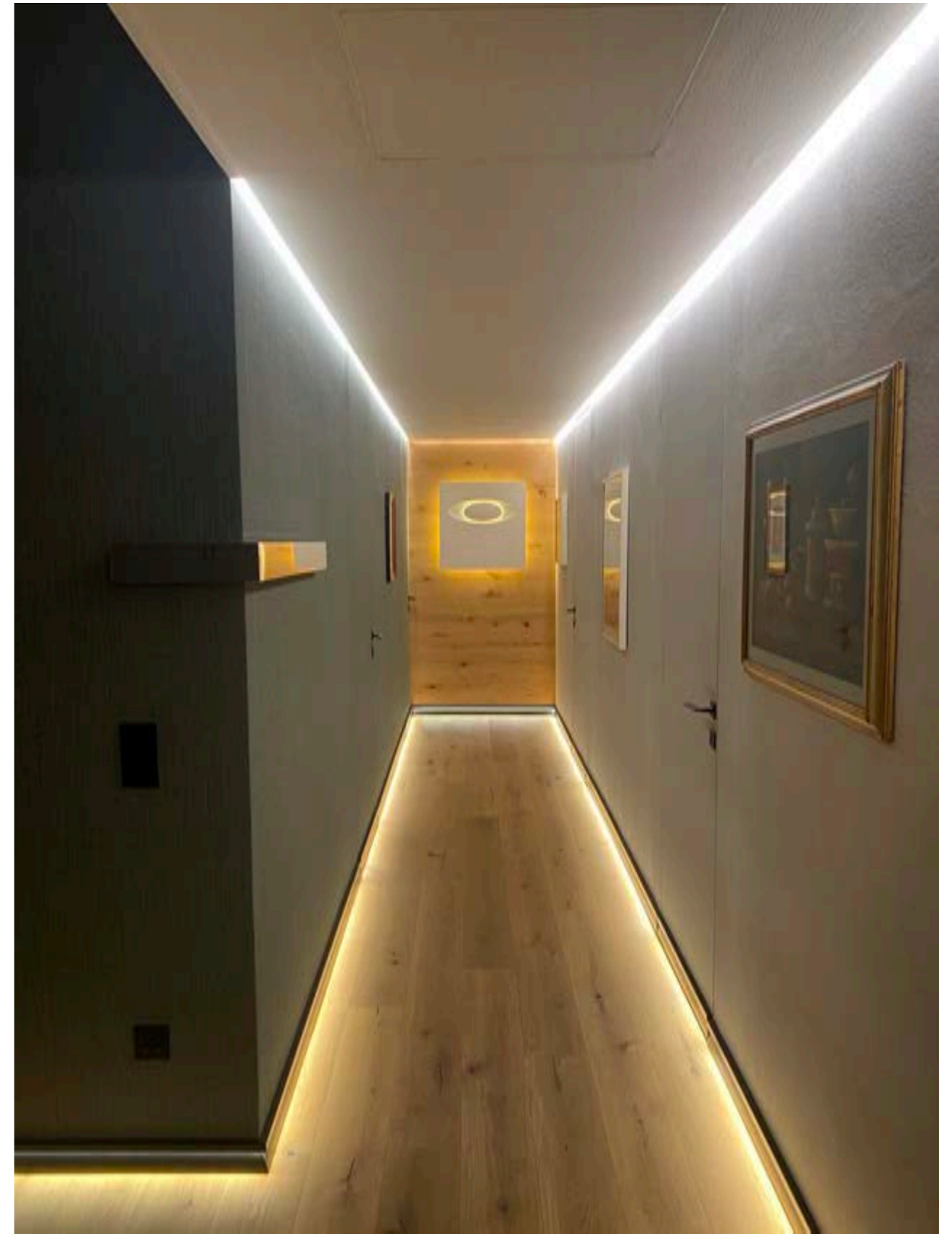

kepler

led integrato

integrated led



DRIVER NON INCLUSO / NOT INCLUDED

LUNGHEZZA CAVO ALIMENTAZIONE : 50 cm
ALIMENTATION CABLE LENGTH : 50 cm

ATTENZIONE! IL PROFILO E' STATO DIMENSIONATO PER UN PANNELLO STANDARD IN CARTONGESSO DI SPESSORE 12,5 mm

WARNING! THE PROFILE HAS BEEN SIZED FOR A STANDARD PLASTERBOARD PANEL OF 12.5 mm THICKNESS

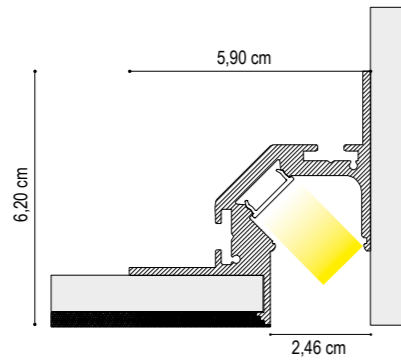

DATI TECNICI
TECHNICAL DATA

COVER RECESSA / RECESSED DIFFUSER

20W/m

	1 cm
LED Flux:	2200 lm/m
Flux Tot:	1760 lm/m
Output:	110 lm/W
CCT:	3000 K
CRI:	>90
Power Tot:	20.0W/m
Weight:	0.90 Kg/m

Alluminio/aluminium
Cover: Opale/opal

1 cm - 2700K

1 cm - 3000K

1 cm - 4000K

FINITURA STRUTTURA
FINISHES

DIFFUSORE
DIFFUSER

CODICE
CODE

CODICE
CODE

CODICE
CODE

BIANCO INTONACO/WHITE
NERO CARAVAGGIO BLACK
ALLUMINIO NATURALE/ALUMINIUM
ORO CALIFORNIA/GOLD

OPALE/OPAL

2125030001
2125040001
2125060001
2125090001

2126030001
2126040001
2126060001
2126090001

2127030001
2127040001
2127060001
2127090001

NEL CODICE PROFILO È INCLUSA LA COVER POSA IN OPERA (COVER MONOUSO PER PROTEGGERE IL PROFILO DURANTE LE FASI DI INSTALLAZIONE)

THE COVER INSTALLED IS INCLUDED IN THE PROFILE CODE (DISPOSABLE COVER TO PROTECT THE PROFILE DURING THE INSTALLATION PHASES)

kepler

led non integrato

not integrated led



ATTENZIONE! IL PROFILO E' STATO DIMENSIONATO PER UN PANNELLO STANDARD IN CARTONGESSO DI SPESSORE 12,5 mm

WARNING! THE PROFILE HAS BEEN SIZED FOR A STANDARD PLASTERBOARD PANEL OF 12.5 mm THICKNESS

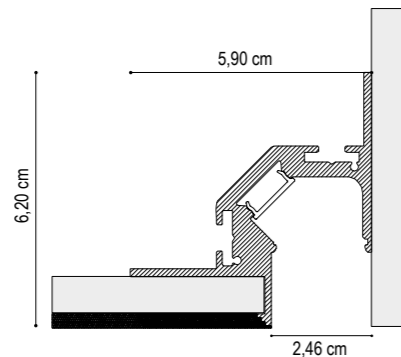

Alluminio/aluminium
Opale/opal

1 cm

200 cm

300 cm

FINITURA STRUTTURA
FINISHES

DIFFUSORE
DIFFUSER

CODICE
CODE

CODICE
CODE

CODICE
CODE

BIANCO INTONACO/WHITE
NERO CARAVAGGIO BLACK
ALLUMINIO NATURALE/ALUMINIUM
ORO CALIFORNIA/GOLD

OPALE/OPAL

2103031001
2103041001
2103061001
2103091001

2103031200
2103041200
2103061200
2103091200

2103031300
2103041300
2103061300
2103091300

kepler

led integrato

integrated led



DRIVER NON INCLUSO / NOT INCLUDED

LUNGHEZZA CAVO ALIMENTAZIONE : 50 cm
ALIMENTATION CABLE LENGTH : 50 cm

ATTENZIONE! IL PROFILO E' STATO DIMENSIONATO PER UN PANNELLO STANDARD IN CARTONGESSO DI SPESSORE 12,5 mm

WARNING! THE PROFILE HAS BEEN SIZED FOR A STANDARD PLASTERBOARD PANEL OF 12.5 mm THICKNESS

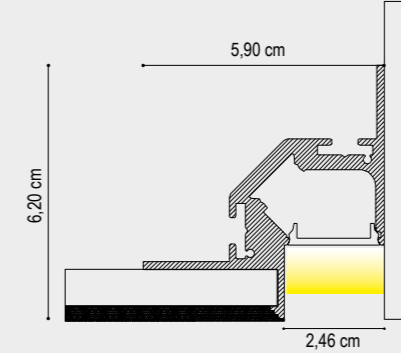

DATI TECNICI
TECHNICAL DATA

COVER ESTERNA / EXTERNAL DIFFUSER

20W/m

	1 cm
LED Flux:	2200 lm/m
Flux Tot:	1760 lm/m
Output:	105 lm/W
CCT:	3000 K
CRI:	>90
Power Tot:	20.0W/m
Weight:	0.90 Kg/m

Alluminio/aluminium
Cover: Opale/opal

1 cm - 2700K

1 cm - 3000K

1 cm - 4000K

FINITURA STRUTTURA
FINISHES

DIFFUSORE
DIFFUSER

CODICE
CODE

CODICE
CODE

CODICE
CODE

BIANCO INTONACO/WHITE
NERO CARAVAGGIO BLACK
ALLUMINIO NATURALE/ALUMINIUM
ORO CALIFORNIA/GOLD

OPALE/OPAL

2125030011
2125040011
2125060011
2125090011

2126030011
2126040011
2126060011
2126090011

2127030011
2127040011
2127060011
2127090011

NEL CODICE PROFILO È INCLUSA LA COVER POSA IN OPERA (COVER MONOUSO PER PROTEGGERE IL PROFILO DURANTE LE FASI DI INSTALLAZIONE)

THE COVER INSTALLED IS INCLUDED IN THE PROFILE CODE (DISPOSABLE COVER TO PROTECT THE PROFILE DURING THE INSTALLATION PHASES)

kepler

led non integrato

not integrated led



ATTENZIONE! IL PROFILO E' STATO DIMENSIONATO PER UN PANNELLO STANDARD IN CARTONGESSO DI SPESSORE 12,5 mm

WARNING! THE PROFILE HAS BEEN SIZED FOR A STANDARD PLASTERBOARD PANEL OF 12.5 mm THICKNESS

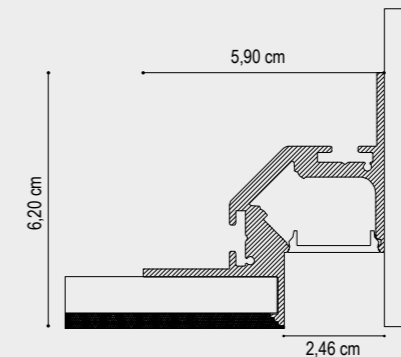

Alluminio/aluminium
Opale/opal

1 cm

200 cm

300 cm

FINITURA STRUTTURA
FINISHES

DIFFUSORE
DIFFUSER

CODICE
CODE

CODICE
CODE

CODICE
CODE

BIANCO INTONACO/WHITE
NERO CARAVAGGIO BLACK
ALLUMINIO NATURALE/ALUMINIUM
ORO CALIFORNIA/GOLD

OPALE/OPAL

2103033001
2103043001
2103063001
2103093001

2103033200
2103043200
2103063200
2103093200

2103033300
2103043300
2103063300
2103093300



TESTATE DI CHIUSURA / DEAD ENDS

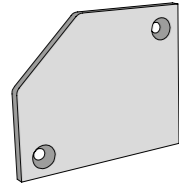

FINITURA STRUTTURA
FINISHES

BIANCO INTONACO/WHITE
NERO CARAVAGGIO/BLACK
ALLUMINIO NATURALE/ALUMINUM
ORO CALIFORNIA/GOLD

CODICE
CODE

210403
210404
210406
210409

GIUNTI / JOINTS

FINITURA
FINISHES

CODICE
CODE

GIUNTO LINEA CONTINUA / STRAIGHT JOINT

Accessorio per giunzioni meccaniche lineari
Accessory for linear mechanical joints

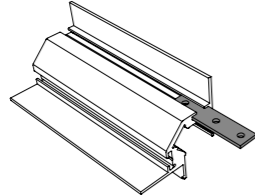

ALLUMINIO NATURALE/ALUMINUM

210501

GIUNTO 90° ORIZZONTALE / HORIZONTAL JOINT
90°

Accessorio per giunzioni meccaniche con angolo
90°
Accessory for linear mechanical joints with 90° angle

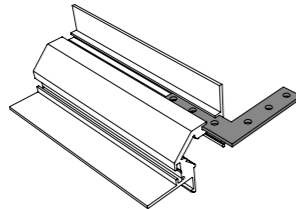

ALLUMINIO NATURALE/ALUMINUM

210500

Il codice contiene 1 giunto con grani.
The code contains 1 joint with grains.

LAVORAZIONI / PROCESSING

DATI TECNICI
TECHNICAL DATA

CODICE
CODE

TAGLIO 90° ORIZZONTALE (PER ANGOLI FORMATI DA DUE PROFILI)
HORIZONTAL 90° CUT (FOR CORNERS MADE OF TWO PROFILES)

190X

TAGLIO 90° VERTICALE (PER ANGOLI FORMATI DA DUE PROFILI)
VERTICAL 90° CUT (FOR CORNERS MADE OF TWO PROFILES)

190Y

ASOLA CUSTOM / CUSTOM SLOT

100N

FORO / HOLE

100F

CABLAGGIO - COLLAUDO - CE AL CENTIMETRO
INSTALLATION AND TESTING LED MODULE AT CENTIMETER

2101

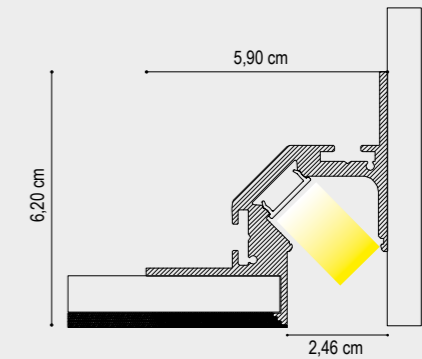

KEPLER CON COVER RECESSA
KEPLER WITH RECESSED COVER

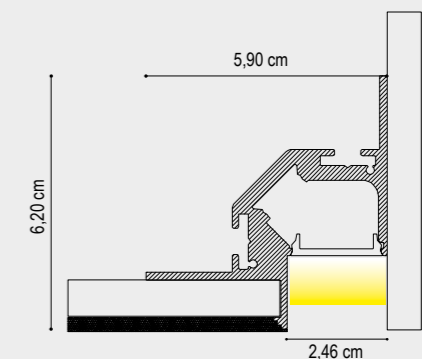

KEPLER CON COVER ESTERNA
KEPLER WITH EXTERNAL COVER

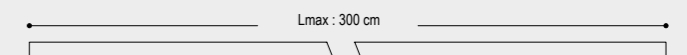

**“tecnologia al top
per qualità, resa cromatica,
lumen emessi, temperatura colore”**

ZER055 costruito in estruso di alluminio si avvale della tecnologia degli schermi in policarbonato per diffondere la luce per mezzo di LED al top, per qualità, resa cromatica, lumen emessi, ed accurata selezione della temperatura colore, scelta in base al progetto scenogra i co che vogliamo ottenere. ZER055 offre una gamma di finiture e di accessori, i tagli lineari e a 45° o su MISURA, rendono realizzabile qualsiasi progetto sia esso da incasso a parete, plafone o sospensione.

ZER055 is made in extruded aluminium. Use polycarbonate technology for diffusing led light with high precision, use high quality like led, colour rendering, lumen output and accurate colour temperature for ensuring optimal results for each type of project. ZER035 offers a wide gamma of finishing's and accessories, several lengths, 45°cuts or completely customized. With Zer035 it's possible to realize any kind of projects like wall-recessed, surface mounting or pendant.



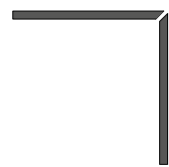

A. COMPOSIZIONE ANGOLARE A "L"
A. L-ANGLE COMPOSITION

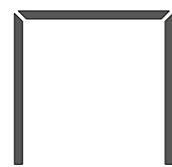

B. COMPOSIZIONE ANGOLARE A "C"
B. C-ANGLE COMPOSITION

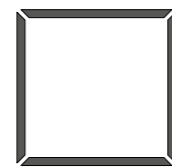

C. COMPOSIZIONE POLIGONALE (QUADRATO/RETTANGOLO)
C. POLYGONAL COMPOSITION (SQUARE / RECTANGLE)



D. COMPOSIZIONE POLIGONALE (PENTAGONO/ESAGONO)
D. POLYGONAL COMPOSITION (PENTAGON / HEX)

INSTALLAZIONE A SOSPENSIONE
SUSPENSION

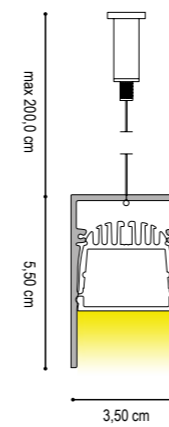

INSTALLAZIONE A SOFFITTO
CEILING INSTALLATION

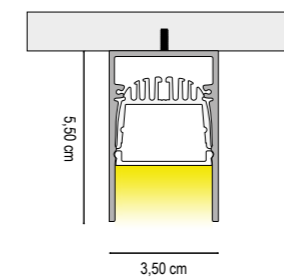

INSTALLAZIONE A INCASSO IN CARTONGESSO
RECESSED INSTALLATION IN PLASTERBOARD

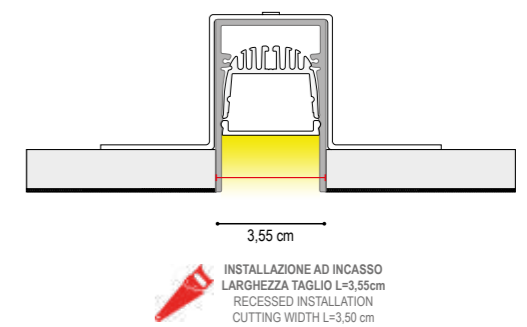

ATTENZIONE! GLI ACCESSORI PER L'INSTALLAZIONE A INCASSO SONO STATI DIMENSIONATI PER UN PANNELLO STANDARD IN CARTONGESSO DI SPESSORE 12,5 mm
WARNING! THE BUILT-IN INSTALLATION ACCESSORIES HAVE BEEN DIMENSIONED FOR A STANDARD PLASTERBOARD PANEL OF 12.5 mm THICKNESS

ESEMPIO 1 / TYPE 1

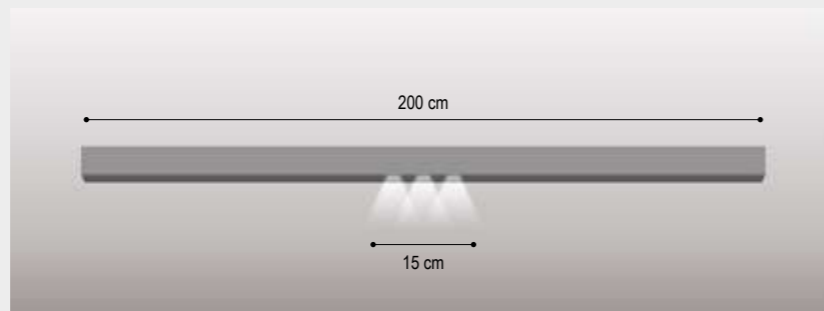

VISTA FRONTALE / FRONT VIEW

ESEMPIO 2 / TYPE 2



VISTA FRONTALE / FRONT VIEW

ESEMPIO 3 / TYPE 3

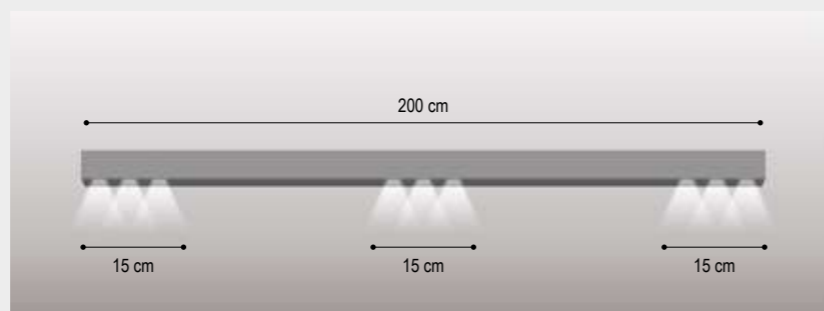

VISTA FRONTALE / FRONT VIEW

ESEMPIO 4 / TYPE 4

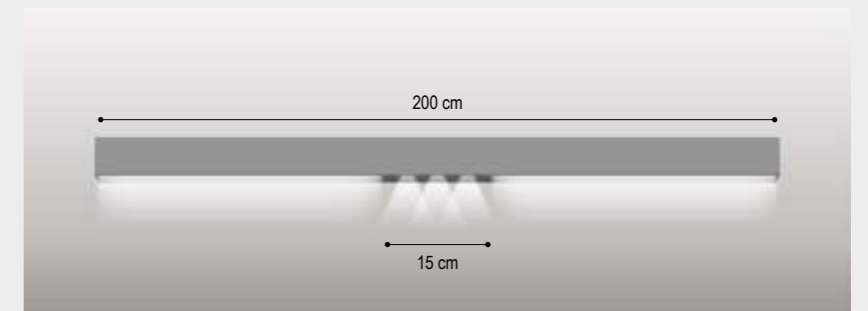

VISTA FRONTALE / FRONT VIEW

ESEMPIO 5 / TYPE 5

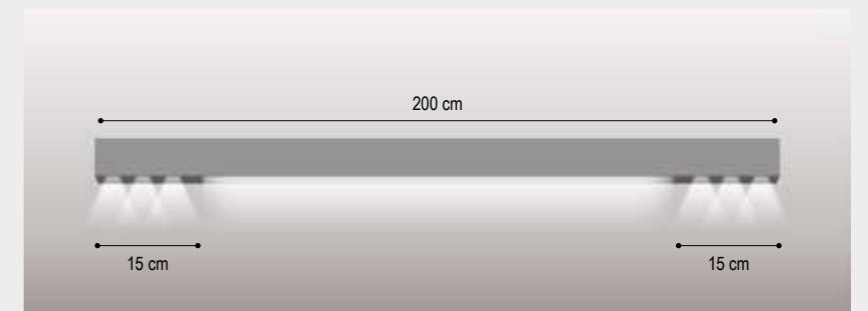

VISTA FRONTALE / FRONT VIEW

ESEMPIO 6 / TYPE 6

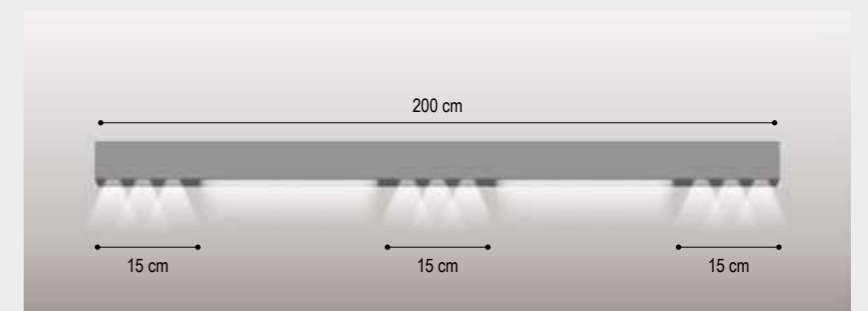

VISTA FRONTALE / FRONT VIEW

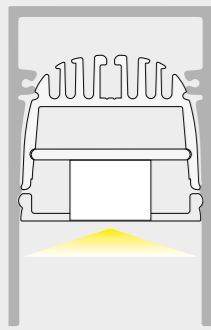

VISTA LATERALE / SIDE VIEW

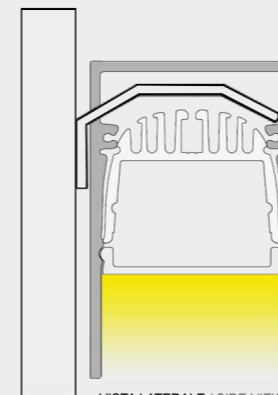

VISTA LATERALE / SIDE VIEW

zero55

led integrato

integrated led

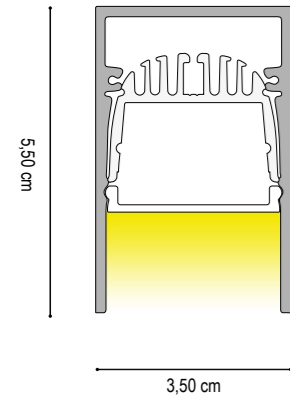

DATI TECNICI
TECHNICAL DATA

	1 cm - 2700K	1 cm - 3000K	1 cm - 4000K
Nominal LED Flux:	2100 lm/m	2200 lm/m	2350 lm/m
Flux Tot:	1680 lm/m	1760 lm/m	1880 lm/m
Output:	105 lm/W	110 lm/W	117 lm/W
CCT:	2700 K	3000 K	4000 K
CRI:	>95	>95	>95
Power Tot:	20.0 W/m	20.0 W/m	20.0 W/m
Weight:	0.90 Kg/m	0.90 Kg/m	0.90 Kg/m

Alluminio/aluminium

Cover: Opale/opal

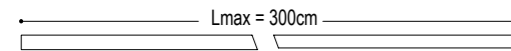

DRIVER NON INCLUSO / NOT INCLUDED

CAVO ALIMENTAZIONE : 50 cm
ALIMENTATION CABLE : 50 cm

zero55 — ugr<19

led integrato

integrated led

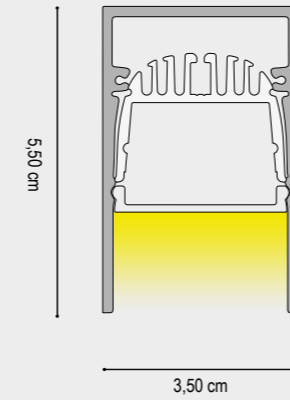

DATI TECNICI
TECHNICAL DATA

	1 cm - 2700K	1 cm - 3000K	1 cm - 4000K
Nominal LED Flux:	2100 lm/m	2200 lm/m	2350 lm/m
Flux Tot:	1890 lm/m	1980 lm/m	2115 lm/m
Output:	105 lm/W	110 lm/W	117 lm/W
CCT:	2700 K	3000 K	4000 K
CRI:	>95	>95	>95
Power Tot:	20.0 W/m	20.0 W/m	20.0 W/m
Weight:	0.90 Kg/m	0.90 Kg/m	0.90 Kg/m

Alluminio/aluminium

Cover: Prismaticata/Prismatic

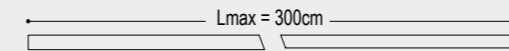

DRIVER NON INCLUSO / NOT INCLUDED

CAVO ALIMENTAZIONE : 50 cm
ALIMENTATION CABLE : 50 cm

FINITURA STRUTTURA
FINISHES

- GRIGIO VESUVIO ANTHRACITE
- ARGILLA CLAY
- ARGENTO OPACO/MATT SILVER
- BIANCO INTONACO/WHITE
- NERO CARAVAGGIO/BLACK
- MOKA MOCHA
- CROMO/CHROME
- ORO CALIFORNIA/GOLD
- ARAMEN COPPER
- GRIGIO AVIO/ GREY AVIO
- ARGENTO COMETA/SILVER COMET
- OTTONE VENEZIANO/BRASS
- TITANIO/TITANIUM
- BRONZO RIACI/RIACI BRONZE
- VERDE COSTA/GREEN COAST
- TERRA SENESE/SENESE EARTH

DIFFUSORE
DIFFUSER

OPALE/OPAL

	1 cm - 2700K	1 cm - 3000K	1 cm - 4000K
CODICE CODE			
5525000001	5526000001	5527000001	
5525010001	5526010001	5527010001	
5525020001	5526020001	5527020001	
5525030001	5526030001	5527030001	
5525040001	5526040001	5527040001	
5525050001	5526050001	5527050001	
5525080001	5526080001	5527080001	
5525090001	5526090001	5527090001	
5525100001	5526100001	5527100001	
5525100001	5526110001	5527110001	
5525120001	5526120001	5527120001	
5525130001	5526130001	5527130001	
5525140001	5526140001	5527140001	
5525150001	5526150001	5527150001	
5525160001	5526160001	5527160001	
5525170001	5526170001	5527170001	

N.B./P.N.:
LUNGHEZZA MASSIMA VERSIONE CROMO = 2,00 m / MAXIMUM LENGTH CHROME VERSION = 2.00 m
TESTATE NON INCLUSE / DEAD ENDS NOT INCLUDED

FINITURA STRUTTURA
FINISHES

- GRIGIO VESUVIO ANTHRACITE
- ARGILLA CLAY
- ARGENTO OPACO/MATT SILVER
- BIANCO INTONACO/WHITE
- NERO CARAVAGGIO/BLACK
- MOKA MOCHA
- CROMO/CHROME
- ORO CALIFORNIA/GOLD
- ARAMEN COPPER
- GRIGIO AVIO/ GREY AVIO
- ARGENTO COMETA/SILVER COMET
- OTTONE VENEZIANO/BRASS
- TITANIO/TITANIUM
- BRONZO RIACI/RIACI BRONZE
- VERDE COSTA/GREEN COAST
- TERRA SENESE/SENESE EARTH

DIFFUSORE
DIFFUSER

PRISMATIZZATO
PRISMATIC

	1 cm - 2700K	1 cm - 3000K	1 cm - 4000K
CODICE CODE			
5525003001	5526003001	5527003001	
5525013001	5526013001	5527013001	
5525023001	5526023001	5527023001	
5525033001	5526033001	5527033001	
5525043001	5526043001	5527043001	
5525053001	5526053001	5527053001	
5525083001	5526083001	5527083001	
5525093001	5526093001	5527093001	
5525103001	5526103001	5527103001	
5525113001	5526113001	5527113001	
5525123001	5526123001	5527123001	
5525133001	5526133001	5527133001	
5525143001	5526143001	5527143001	
5525153001	5526153001	5527153001	
5525163001	5526163001	5527163001	
5525173001	5526173001	5527173001	

N.B./P.N.:
LUNGHEZZA MASSIMA VERSIONE CROMO = 2,00 m / MAXIMUM LENGTH CHROME VERSION = 2.00 m
TESTATE NON INCLUSE / DEAD ENDS NOT INCLUDED

zero55

led integrato

integrated led

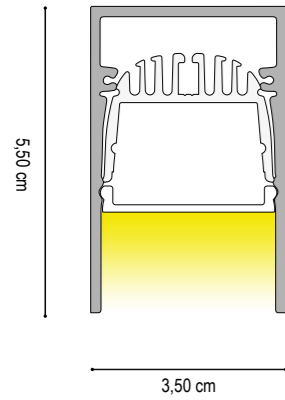

DATI TECNICI
TECHNICAL DATA

	1 cm - 2700K	1 cm - 3000K	1 cm - 4000K
Nominal LED Flux:	2916 lm/m	3024 lm/m	3125 lm/m
Flux Tot:	2333 lm/m	2419 lm/m	2500 lm/m
Output:	135 lm/W	140 lm/W	145 lm/W
CCT:	2700 K	3000 K	4000 K
CRI:	>95	>95	>98
Power Tot:	22 W/m	22 W/m	22 W/m
Weight:	0.90 Kg/m	0.90 Kg	0.90 Kg

Alluminio/aluminium

Cover: Opale/opal

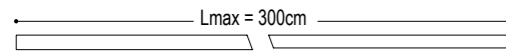

DRIVER NON INCLUSO / NOT INCLUDED

CAVO ALIMENTAZIONE : 50 cm
ALIMENTATION CABLE : 50 cm

FINITURA STRUTTURA
FINISHES

- GRIGIO VESUVIO ANTHRACITE
- ARGILLA CLAY
- ARGENTO OPACO/MATT SILVER
- BIANCO INTONACO/WHITE
- NERO CARAVAGGIO/BLACK
- MOKA MOCHA
- CROMO/CHROME
- ORO CALIFORNIA/GOLD
- ARAMEN COPPER
- GRIGIO AVIO/ GREY AVIO
- ARGENTO COMETA/SILVER COMET
- OTTONE VENEZIANO/BRASS
- TITANIO/TITANIUM
- BRONZO RIACI/RIACI BRONZE
- VERDE COSTA/GREEN COAST
- TERRA SENESE/SENESE EARTH

DIFFUSORE
DIFFUSER

OPALE/OPAL

	1 cm - 2700K	1 cm - 3000K	1 cm - 4000K
CODICE CODE	CODICE CODE	CODICE CODE	CODICE CODE
5586000001	5587000001	5588000001	
5586010001	5587010001	5588010001	
5586020001	5587020001	5588020001	
5586030001	5587030001	5588030001	
5586040001	5587040001	5588040001	
5586050001	5587050001	5588050001	
5586080001	5587080001	5588080001	
5586090001	5587090001	5588090001	
5586100001	5587100001	5588100001	
5586110001	5587110001	5588110001	
5586120001	5587120001	5588120001	
5586130001	5587130001	5588130001	
5586140001	5587140001	5588140001	
5586150001	5587150001	5588150001	
5586160001	5587160001	5588160001	
5586170001	5587170001	5588170001	

N.B./P.N.:
LUNGHEZZA MASSIMA VERSIONE CROMO = 2,00 m / MAXIMUM LENGTH CHROME VERSION = 2.00 m
TESTATE NON INCLUSE / DEAD ENDS NOT INCLUDED

zero55 — ugr<19

led integrato

integrated led

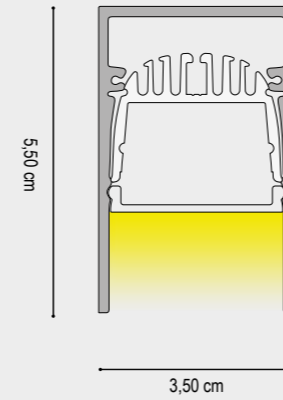

DATI TECNICI
TECHNICAL DATA

	1 cm - 2700K	1 cm - 3000K	1 cm - 4000K
Nominal LED Flux:	2916 lm/m	3024 lm/m	3125 lm/m
Flux Tot:	2624 lm/m	2722 lm/m	2812 lm/m
Output:	135 lm/W	140 lm/W	145 lm/W
CCT:	2700 K	3000 K	4000 K
CRI:	>95	>95	>95
Power Tot:	22 W/m	22 W/m	22 W/m
Weight:	0.90 Kg/m	0.90 Kg	0.90 Kg

Alluminio/aluminium

Cover: Prismatic/Prismatic

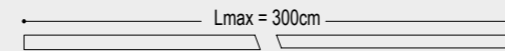

DRIVER NON INCLUSO / NOT INCLUDED

CAVO ALIMENTAZIONE : 50 cm
ALIMENTATION CABLE : 50 cm

FINITURA STRUTTURA
FINISHES

- GRIGIO VESUVIO ANTHRACITE
- ARGILLA CLAY
- ARGENTO OPACO/MATT SILVER
- BIANCO INTONACO/WHITE
- NERO CARAVAGGIO/BLACK
- MOKA MOCHA
- CROMO/CHROME
- ORO CALIFORNIA/GOLD
- ARAMEN COPPER
- GRIGIO AVIO/ GREY AVIO
- ARGENTO COMETA/SILVER COMET
- OTTONE VENEZIANO/BRASS
- TITANIO/TITANIUM
- BRONZO RIACI/RIACI BRONZE
- VERDE COSTA/GREEN COAST
- TERRA SENESE/SENESE EARTH

DIFFUSORE
DIFFUSER

PRISMATIZZATO
PRISMATIC

	1 cm - 2700K	1 cm - 3000K	1 cm - 4000K
CODICE CODE	CODICE CODE	CODICE CODE	CODICE CODE
5586003001	5587003001	5588003001	
5586013001	5587013001	5588013001	
5586023001	5587023001	5588023001	
5586033001	5587033001	5588033001	
5586043001	5587043001	5588043001	
5586053001	5587053001	5588053001	
5586083001	5587083001	5588083001	
5586093001	5587093001	5588093001	
5586103001	5587103001	5588103001	
5586113001	5587113001	5588113001	
5586123001	5587123001	5588123001	
5586133001	5587133001	5588133001	
5586143001	5587143001	5588143001	
5586153001	5587153001	5588153001	
5586163001	5587163001	5588163001	
5586173001	5587173001	5588173001	

N.B./P.N.:
LUNGHEZZA MASSIMA VERSIONE CROMO = 2,00 m / MAXIMUM LENGTH CHROME VERSION = 2.00 m
TESTATE NON INCLUSE / DEAD ENDS NOT INCLUDED

zero55

led integrato

integrated led

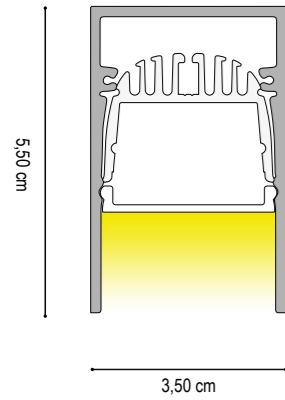

DATI TECNICI
TECHNICAL DATA

	1 cm - 2700K	1 cm - 3000K	1 cm - 4000K
Nominal LED Flux:	3900 lm/m	4050 lm/m	4200 lm/m
Flux Tot:	3120 lm/m	3240 lm/m	3360 lm/m
Output:	130 lm/W	135 lm/W	140 lm/W
CCT:	2700 K	3000 K	4000 K
CRI:	>90	>90	>90
Power Tot:	30.0 W/m	30.0 W/m	30.0 W/m
Weight:	0.90 Kg/m	0.90 Kg/m	0.90 Kg/m

Alluminio/aluminium

Cover: Opale/opal

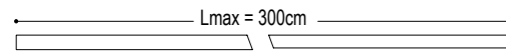

DRIVER NON INCLUSO / NOT INCLUDED

CAVO ALIMENTAZIONE : 50 cm
ALIMENTATION CABLE : 50 cm

FINITURA STRUTTURA
FINISHES

- GRIGIO VESUVIO ANTHRACITE
- ARGILLA CLAY
- ARGENTO OPACO/MATT SILVER
- BIANCO INTONACO/WHITE
- NERO CARAVAGGIO/BLACK
- MOKA MOCHA
- CROMO/CHROME
- ORO CALIFORNIA/GOLD
- ARAMEN COPPER
- GRIGIO AVIO/ GREY AVIO
- ARGENTO COMETA/SILVER COMET
- OTTONE VENEZIANO/BRASS
- TITANIO/TITANIUM
- BRONZO RIACI/RIACI BRONZE
- VERDE COSTA/GREEN COAST
- TERRA SENESE/SENESE EARTH

DIFFUSORE
DIFFUSER

OPALE/OPAL

	1 cm - 2700K CODICE CODE	1 cm - 3000K CODICE CODE	1 cm - 4000K CODICE CODE
	5580000001	5581000001	5582000001
	5580010001	5581010001	5582010001
	5580020001	5581020001	5582020001
	5580030001	5581030001	5582030001
	5580040001	5581040001	5582040001
	5580050001	5581050001	5582050001
	5580080001	5581080001	5582080001
	5580090001	5581090001	5582090001
	5580100001	5581100001	5582100001
	5580110001	5581110001	5582110001
	5580120001	5581120001	5582120001
	5580130001	5581130001	5582130001
	5580140001	5581140001	5582140001
	5580150001	5581150001	5582150001
	5580160001	5581160001	5582160001
	5580170001	5581170001	5582170001

N.B./P.N.:

LUNGHEZZA MASSIMA VERSIONE CROMO = 2,00 m / MAXIMUM LENGTH CHROME VERSION = 2.00 m
TESTATE NON INCLUSE / DEAD ENDS NOT INCLUDED

zero55 — ugr<19

led integrato

integrated led

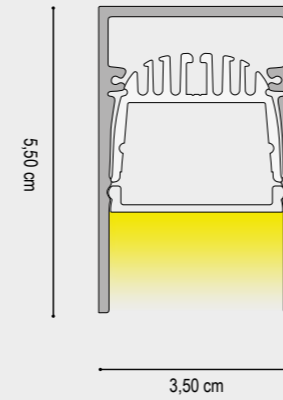

DATI TECNICI
TECHNICAL DATA

	1 cm - 2700K	1 cm - 3000K	1 cm - 4000K
Nominal LED Flux:	3900 lm/m	4050 lm/m	4200 lm/m
Flux Tot:	3375 lm/m	3510 lm/m	3645 lm/m
Output:	130 lm/W	135 lm/W	140 lm/W
CCT:	2700 K	3000 K	4000 K
CRI:	>90	>90	>90
Power Tot:	30.0 W/m	30.0 W/m	30.0 W/m
Weight:	0.90 Kg/m	0.90 Kg/m	0.90 Kg/m

Alluminio/aluminium

Cover: Prismaticata/Prismatic

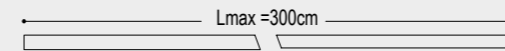

DRIVER NON INCLUSO / NOT INCLUDED

CAVO ALIMENTAZIONE : 50 cm
ALIMENTATION CABLE : 50 cm

FINITURA STRUTTURA
FINISHES

- GRIGIO VESUVIO ANTHRACITE
- ARGILLA CLAY
- ARGENTO OPACO/MATT SILVER
- BIANCO INTONACO/WHITE
- NERO CARAVAGGIO/BLACK
- MOKA MOCHA
- CROMO/CHROME
- ORO CALIFORNIA/GOLD
- ARAMEN COPPER
- GRIGIO AVIO/ GREY AVIO
- ARGENTO COMETA/SILVER COMET
- OTTONE VENEZIANO/BRASS
- TITANIO/TITANIUM
- BRONZO RIACI/RIACI BRONZE
- VERDE COSTA/GREEN COAST
- TERRA SENESE/SENESE EARTH

DIFFUSORE
DIFFUSER

PRISMATIZZATO
PRISMATIC

	1 cm - 2700K CODICE CODE	1 cm - 3000K CODICE CODE	1 cm - 4000K CODICE CODE
	5580003001	5581003001	5582003001
	5580013001	5581013001	5582013001
	5580023001	5581023001	5582023001
	5580033001	5581033001	5582033001
	5580043001	5581043001	5582043001
	5580053001	5581053001	5582053001
	5580083001	5581083001	5582083001
	5580093001	5581093001	5582093001
	5580103001	5581103001	5582103001
	5580113001	5581113001	5582113001
	5580123001	5581123001	5582123001
	5580133001	5581133001	5582133001
	5580143001	5581143001	5582143001
	5580153001	5581153001	5582153001
	5580163001	5581163001	5582163001
	5580173001	5581173001	5582173001

N.B./P.N.:

LUNGHEZZA MASSIMA VERSIONE CROMO = 2,00 m / MAXIMUM LENGTH CHROME VERSION = 2.00 m
TESTATE NON INCLUSE / DEAD ENDS NOT INCLUDED

zero55 p

led integrato

integrated led

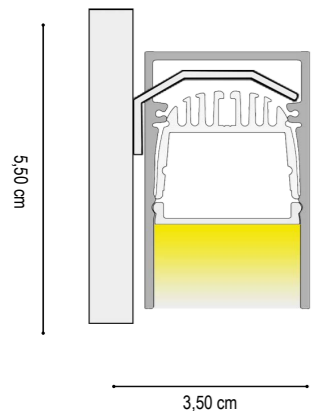

Nominal LED Flux:
Flux Tot:
Output:
CCT:
CRI:
Power Tot:
Weight:

DATI TECNICI TECHNICAL DATA		
2100 lm/m	2200 lm/m	2350 lm/m
1680 lm/m	1760 lm/m	1880 lm/m
105 lm/W	110 lm/W	117 lm/W
2700 K	3000 K	4000 K
>95	>95	>95
20.0 W/m	20.0 W/m	20.0 W/m
0.90 Kg/m	0.90 Kg/m	0.90 Kg/m

Alluminio/aluminium

Cover: Opale/opal

3,50 cm

Lmax = 300cm

DRIVER NON INCLUSO / NOT INCLUDED

CAVO ALIMENTAZIONE : 50 cm
ALIMENTATION CABLE : 50 cm

FINITURA STRUTTURA
FINISHES

- GRIGIO VESUVIO ANTHRACITE
- ARGILLA CLAY
- ARGENTO OPACO/MATT SILVER
- BIANCO INTONACO/WHITE
- NERO CARAVAGGIO/BLACK
- MOKA MOCHA
- CROMO/CHROME
- ORO CALIFORNIA/GOLD
- ARAMEN COPPER
- GRIGIO AVIO/GREY AVIO
- ARGENTO COMETA/SILVER COMET
- OTTONE VENEZIANO/BRASS
- TITANIO/TITANIUM
- BRONZO RIACI/RIACI BRONZE
- VERDE COSTA/GREEN COAST
- TERRA SENESE/SENESE EARTH

DIFFUSORE
DIFFUSER

OPALE/OPAL

1 cm - 2700K

CODICE CODE
5525000021
5525010021
5525020021
5525030021
5525040021
5525050021
5525080001
5525090001
5525100021
5525110021
5525120021
5525130021
5525140021
5525150021
5525160021
5525170021

1 cm - 3000K

CODICE CODE
5526000021
5526010021
5526020021
5526030021
5526040021
5526050021
5526080021
5526090021
5526100021
5526110021
5526120021
5526130021
5526140021
5526150021
5526160021
5526170021

1 cm - 4000K

CODICE CODE
5527000021
5527010021
5527020021
5527030021
5527040021
5527050021
5527080021
5527090021
5527100021
5527110021
5527120021
5527130021
5527140021
5527150021
5527160021
5527170021

N.B./P.N.:
LUNGHEZZA MASSIMA VERSIONE CROMO = 2,00 m / MAXIMUM LENGTH CHROME VERSION = 2.00 m
TESTATE NON INCLUSE / DEAD ENDS NOT INCLUDED

zero55 p

led integrato

integrated led

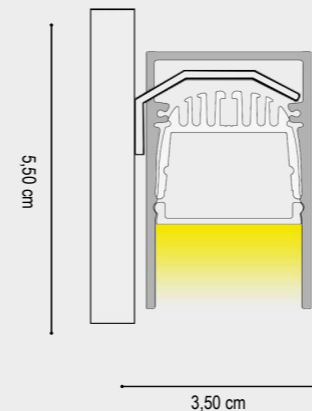

Nominal LED Flux:
Flux Tot:
Output:
CCT:
CRI:
Power Tot:
Weight:

DATI TECNICI TECHNICAL DATA		
1 cm - 2700K	1 cm - 3000K	1 cm - 4000K
3900 lm/m	4050 lm/m	4200 lm/m
3120 lm/m	3240 lm/m	3570 lm/m
130 lm/W	135 lm/W	140 lm/W
2700 K	3000 K	4000 K
>90	>90	>90
30.0 W/m	30.0 W/m	30.0 W/m
0.90 Kg/m	0.90 Kg/m	0.90 Kg/m

Alluminio/aluminium

Cover: Prismaticata/Prismatic

3,50 cm

Lmax = 300cm

DRIVER NON INCLUSO / NOT INCLUDED

CAVO ALIMENTAZIONE : 50 cm
ALIMENTATION CABLE : 50 cm

FINITURA STRUTTURA
FINISHES

- GRIGIO VESUVIO ANTHRACITE
- ARGILLA CLAY
- ARGENTO OPACO/MATT SILVER
- BIANCO INTONACO/WHITE
- NERO CARAVAGGIO/BLACK
- MOKA MOCHA
- CROMO/CHROME
- ORO CALIFORNIA/GOLD
- ARAMEN COPPER
- GRIGIO AVIO/GREY AVIO
- ARGENTO COMETA/SILVER COMET
- OTTONE VENEZIANO/BRASS
- TITANIO/TITANIUM
- BRONZO RIACI/RIACI BRONZE
- VERDE COSTA/GREEN COAST
- TERRA SENESE/SENESE EARTH

DIFFUSORE
DIFFUSER

OPALE/OPAL

1 cm - 2700K

CODICE CODE
5580000021
5580010021
5580020021
5580030021
5580040021
5580050021
5580080021
5580090021
5580100021
5580110021
5580120021
5580130021
5580140021
5580150021
5580160021
5580170021

1 cm - 3000K

CODICE CODE
5581000021
5581010021
5581020021
5581030021
5581040021
5581050021
5581080021
5581090021
5581100021
5581110021
5581120021
5581130021
5581140021
5581150021
5581160021
5581170021

1 cm - 4000K

CODICE CODE
5582000021
5582010021
5582020021
5582030021
5582040021
5582050021
5582080021
5582090021
5582100021
5582110021
5582120021
5582130021
5582140021
5582150021
5582160021
5582170021

N.B./P.N.:
LUNGHEZZA MASSIMA VERSIONE CROMO = 2,00 m / MAXIMUM LENGTH CHROME VERSION = 2.00 m
TESTATE NON INCLUSE / DEAD ENDS NOT INCLUDED

zero55

led non integrato

not integrated led

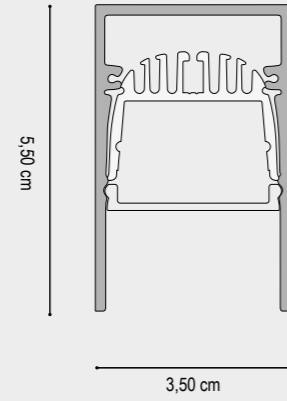

zero55

accessori

accessories



FINITURA STRUTTURA FINISHES	DIFFUSORE DIFFUSER	1 cm	200 cm	300 cm
		CODICE CODE	CODICE CODE	CODICE CODE
GRIGIO VESUVIO ANTHRACITE	OPALE/OPAL	5503000001	5503000200	5503000300
ARGILLA CLAY		5503010001	5503010200	5503010300
ARGENTO OPACO/MATT SILVER		5503020001	5503020200	5503020300
BIANCO INTONACO/WHITE		5503030001	5503030200	5503030300
NERO CARAVAGGIO/BLACK		5503040001	5503040200	5503040300
MOKA MOCHA		5503050001	5503050200	5503050300
CROMO/CHROME		5503080001	5503080200	-----
ORO CALIFORNIA/GOLD		5503090001	5503090200	5503090300
ARAMEN COPPER		5503100001	5503100200	5503100300
GRIGIO AVIO/GREY AVIO		5503110001	5503110200	5503110300
ARGENTO COMETA/SILVER COMET		5503120001	5503120200	5503120300
OTTONE VENEZIANO/BRASS		5503130001	5503130200	5503130300
TITANIO/TITANIUM		5503140001	5503140200	5503140300
BRONZO RIACI/RIACI BRONZE		5503150001	5503150200	5503150300
VERDE COSTA/GREEN COAST		5503160001	5503160200	5503160300
TERRA SENESE/SENESE EARTH		5503170001	5503170200	5503170300

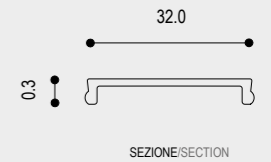

COVER ALLUMINIO / ALUMINUM COVER

N.B./P.N.:
LUNGHEZZA MASSIMA VERSIONE CROMO = 2,00 m / MAXIMUM LENGTH CHROME VERSION = 2.00 m
TESTATE NON INCLUDE / DEAD ENDS NOT INCLUDED

DIFFUSORE DIFFUSER	1 cm	200 cm	300 cm	400 cm
	CODICE CODE	CODICE CODE	CODICE CODE	CODICE CODE
OPALE/OPAL	1100100001	1100100200	1100100300	1100100400
SATINATA/SATIN	1100101001	1100101200	1100101300	1100101400
PRISMATIZZATO/PRISMATIC	1100103001	1100103200	1100103300	1100103400
ECLISSI/ECLIPSE	1100106001	1100106200	1100106300	1100106400

FINITURA STRUTTURA FINISHES	1 cm	1 cm	
	CODICE CODE	CODICE CODE	
GRIGIO VESUVIO ANTHRACITE	1100500001	ARAMEN COPPER	1100510001
ARGILLA CLAY	1100501001	GRIGIO AVIO/GREY AVIO	1100511001
ARGENTO OPACO/MATT SILVER	1100502001	ARGENTO COMETA/SILVER COMET	1100512001
BIANCO INTONACO/WHITE	1100503001	OTTONE VENEZIANO/BRASS	1100513001
NERO CARAVAGGIO/BLACK	1100504001	TITANIO/TITANIUM	1100514001
MOKA MOCHA	1100505001	BRONZO RIACI/RIACI BRONZE	1100515001
CROMO/CHROME	1100508001	VERDE COSTA/GREEN COAST	1100516001
ORO CALIFORNIA/GOLD	1100509001	TERRA SENESE/SENESE EARTH	1100517001

TESTATE DI CHIUSURA / DEAD ENDS

FINITURA STRUTTURA FINISHES	CODICE CODE	FINITURA STRUTTURA FINISHES	CODICE CODE
GRIGIO VESUVIO ANTHRACITE	550400	ARAMEN COPPER	550410
ARGILLA CLAY	550401	GRIGIO AVIO GREY AVIO	550411
ARGENTO OPACO MATT SILVER	550402	ARGENTO COMETA SILVER COMET	550412
BIANCO INTONACO WHITE	550403	OTTONE VENEZIANO BRASS	550413
NERO CARAVAGGIO BLACK	550404	TITANIO/TITANIUM	550414
MOKA MOCHA	550405	BRONZO RIACI/RIACI BRONZE	550415
CROMO CHROME	550408	VERDE COSTA GREEN COAST	550416
ORO CALIFORNIA GOLD	550409	TERRA SENESE SENESE EARTH	550417

Nel codice sono comprese le viti per il fissaggio delle testate al profilo. Il codice contiene n° 1 testate di chiusura.
The code includes the screws for fixing the heads to the profile. The code contains 1 closing warheads

KIT DI SOSPENSIONE / SUSPENSION KIT

ARTICOLI INCLUSI NEL CODICE
ARTICLES INCLUDED IN THE CODE

Cavo in acciaio 2,00m con puntalino
2.00m steel cable with tip
Boccola cromata con regolazione millimetrica
Chrome bush with millimeter adjustment

Cavo in acciaio 3,00m con puntalino
3.00m steel cable with tip

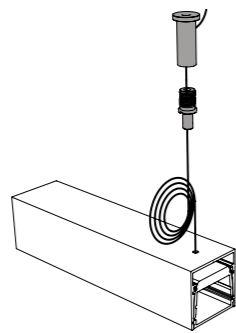

FINITURA
FINISHES

CROMO CHROME

CODICE
CODE

1100508200

1100508F30

STAFFA DI FISSAGGIO A CARTONGESSO / MOUNTING CLIP FOR PLASTERBOARD

Accessorio che consente l'incasso del modello.
Accessory that allows the collection of the model.

Nel codice sono comprese le viti per il fissaggio del modello alla staffa. The code includes screws for fixing the model to the bracket.

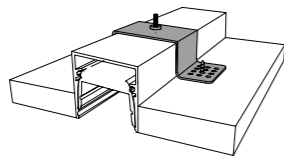

FINITURA
FINISHES

ALLUMINIO NATURALE ALUMINUM

CODICE
CODE

550502

GIUNTI / JOINTS

		FINITURA FINISHES	CODICE CODE
GIUNTO LINEA CONTINUA / STRAIGHT JOINT Accessorio per giunzioni meccaniche lineari Accessory for linear mechanical joints		ALLUMINIO NATURALE ALUMINUM	55050601
GIUNTO 90° ORIZZONTALE / HORIZONTAL JOINT 90° Accessorio per giunzioni meccaniche con angolo 90° Accessory for linear mechanical joints with 90° angle		ALLUMINIO NATURALE ALUMINUM	55050602
GIUNTO 90° VERTICALE INTERNO / VERTICAL JOINT 90° Accessorio per giunzioni meccaniche con angolo 90° Accessory for linear mechanical joints with 90° angle		ALLUMINIO NATURALE ALUMINUM	55050603
GIUNTO 90° ANGOLARE VERTICALE ESTERNO / VERTICAL JOINT 90° Accessorio per giunzioni meccaniche con angolo 90° Accessory for linear mechanical joints with 90° angle		ALLUMINIO NATURALE ALUMINUM	55050604
GIUNTO ANGOLARE A T / ANGULAR T-JOINT Accessorio per giunzioni meccaniche a T Accessory for mechanical T-junctions		ALLUMINIO NATURALE ALUMINUM	55050606
GIUNTO ANGOLARE A X / ANGULAR T-JOINT Accessorio per giunzioni meccaniche a X Accessory for mechanical T-junctions		ALLUMINIO NATURALE ALUMINUM	55050607

LAVORAZIONI / PROCESSING

DATI TECNICI TECHNICAL DATA	CODICE CODE
TAGLIO 90° ORIZZONTALE (PER ANGOLI FORMATI DA DUE PROFILI) HORIZONTAL 90° CUT (FOR CORNERS MADE OF TWO PROFILES)	190X
TAGLIO 90° VERTICALE (PER ANGOLI FORMATI DA DUE PROFILI) VERTICAL 90° CUT (FOR CORNERS MADE OF TWO PROFILES)	190Y
TAGLIO ANGOLARE CUSTOM (PER ANGOLI FORMATI DA DUE PROFILI) CUSTOM CORNER CUT (FOR CORNERS MADE OF TWO PROFILES)	190N
ASOLA CUSTOMIZZATA / CUSTOM SLOT	100N
FORO / HOLE	100F
CABLAGGIO - COLLAUDO - CE LED AL CENTIMETRO INSTALLATION AND TESTING LED MODULE AT CENTIMETER	1101
CONNETTORE MASCHIO/FEMMINA MALE/FEMALE CONNECTOR	98CFM
CONNETTORE MASCHIO/FEMMINA MONTATO NEL PRODOTTO MALE/ FEMALE CONNECTOR FITTED IN THE PRODUCT	98MFM
CAVO DI ALIMENTAZIONE 2X0,75 TONDO TRASPARENTE 1CM POWER CABLE 2X0,75 ROUND TRANSPARENT 1CM	98CTT001

**“tecnologia al top
per qualità, resa cromatica,
lumen emessi, temperatura colore”**

ZER075 costruito in estruso di alluminio si avvale della tecnologia degli schermi in policarbonato per diffondere la luce per mezzo di LED al top, per qualità, resa cromatica, lumen emessi, ed accurata selezione della temperatura colore, scelta in base al progetto scenogra i co che vogliamo ottenere. ZER075 offre una gamma di finiture e di accessori, i tagli lineari e a 45° o su MISURA, rendono realizzabile qualsiasi progetto sia esso da incasso a parete, plafone o sospensione.

ZER075 is made in extruded aluminium. Use polycarbonate technology for diffusing led light with high precision, use high quality like led, colour rendering, lumen output and accurate colour temperature for ensuring optimal results for each type of project. ZER035 offers a wide gamma of finishing's and accessories, several lengths, 45°cuts or completely customized. With Zer035 it's possible to realize any kind of projects like wall-recessed, surface mounting or pendant.

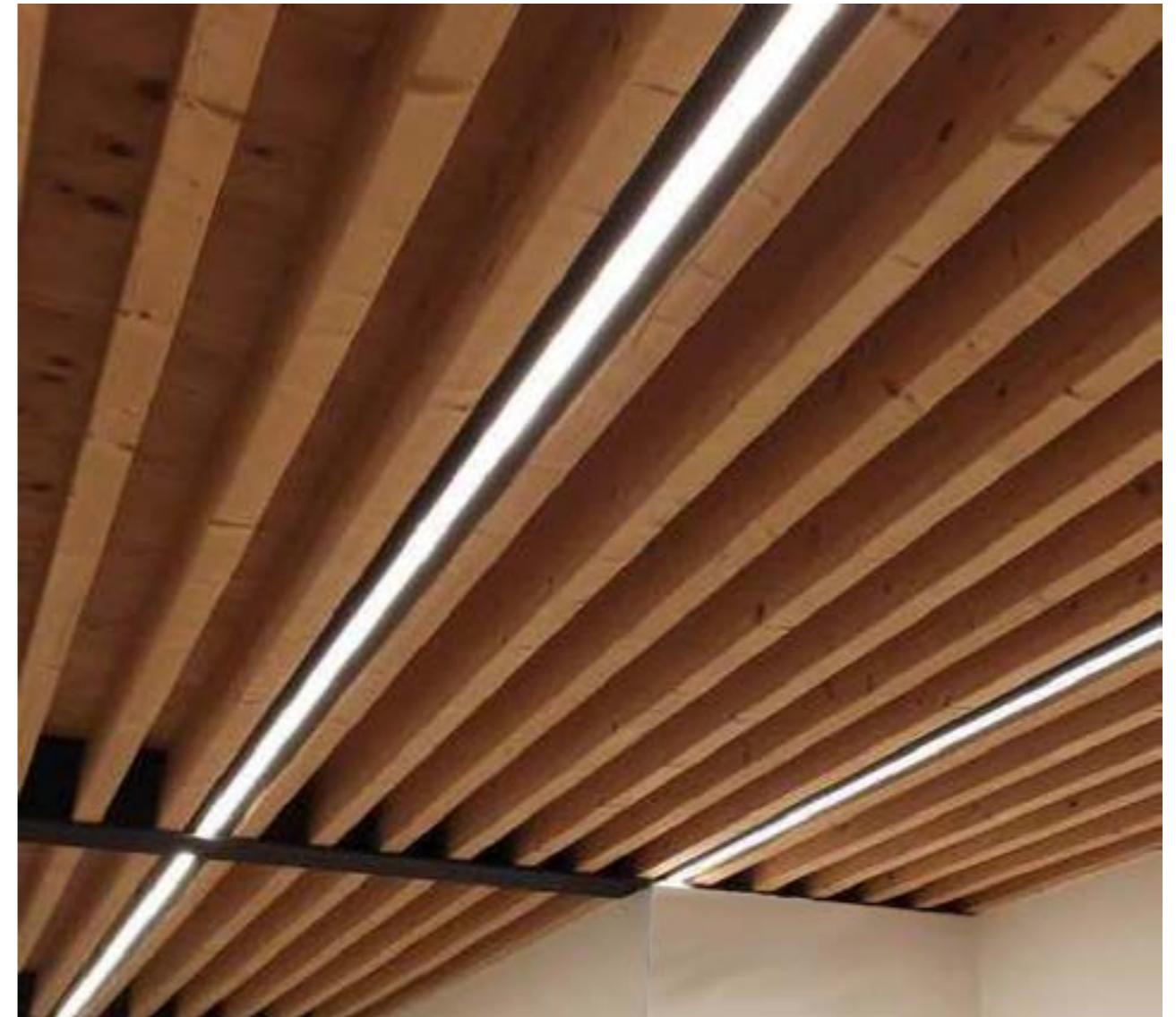

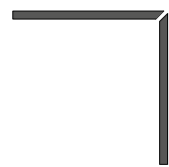

A. COMPOSIZIONE ANGOLARE A "L"
A. L-ANGLE COMPOSITION

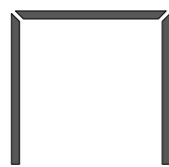

B. COMPOSIZIONE ANGOLARE A "C"
B. C-ANGLE COMPOSITION

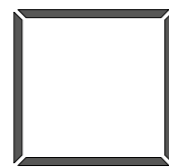

C. COMPOSIZIONE POLIGONALE (QUADRATO/RETTANGOLO)
C. POLYGONAL COMPOSITION (SQUARE / RECTANGLE)



D. COMPOSIZIONE POLIGONALE (PENTAGONO/ESAGONO)
D. POLYGONAL COMPOSITION (PENTAGON / HEX)

INSTALLAZIONE A SOSPENSIONE
SUSPENSION

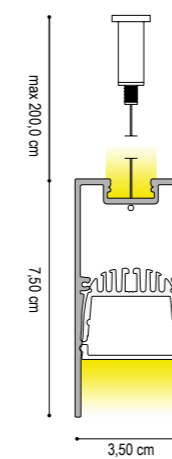

INSTALLAZIONE A SOSPENSIONE
SUSPENSION

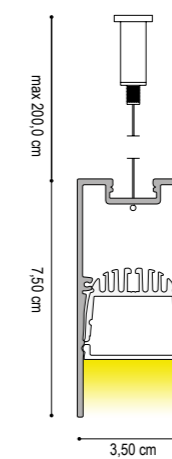

INSTALLAZIONE A PLAFONE
CEILING INSTALLATION

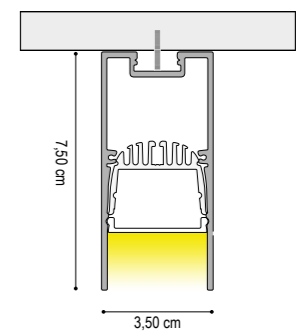

ESEMPIO 1 / TYPE 1

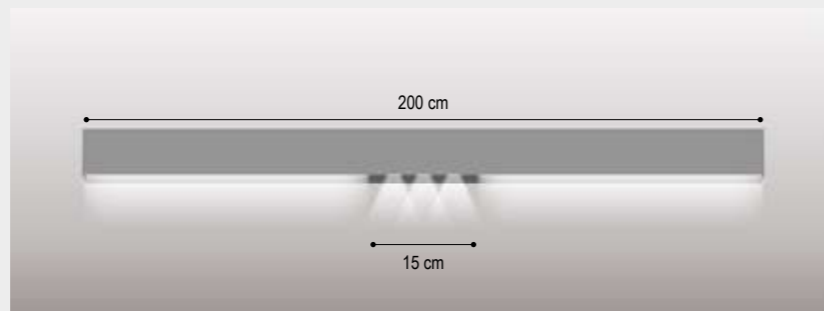

VISTA FRONTALE / FRONT VIEW

ESEMPIO 2 / TYPE 2

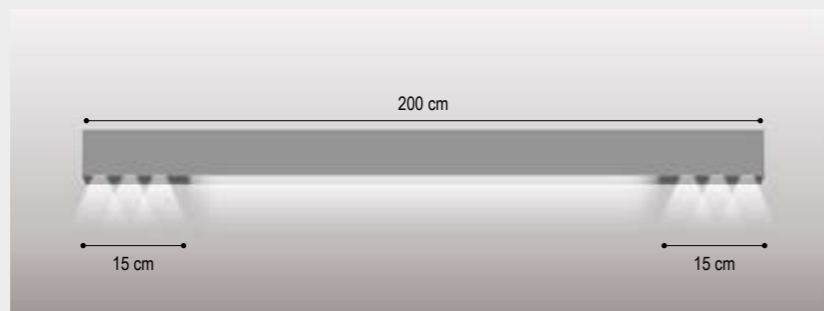

VISTA LATERALE / SIDE VIEW

ESEMPIO 3 / TYPE 3

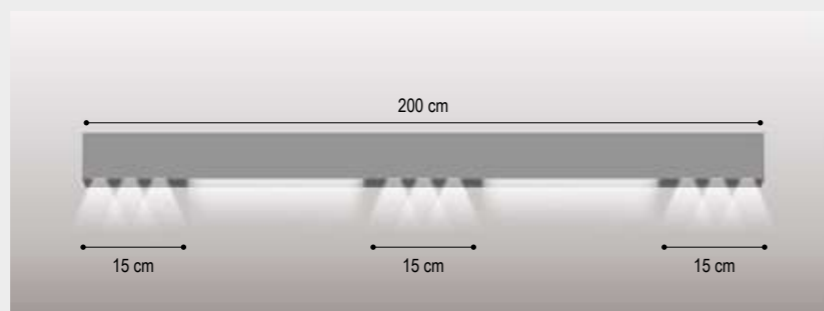

VISTA FRONTALE / FRONT VIEW

ESEMPIO 4 / TYPE 4

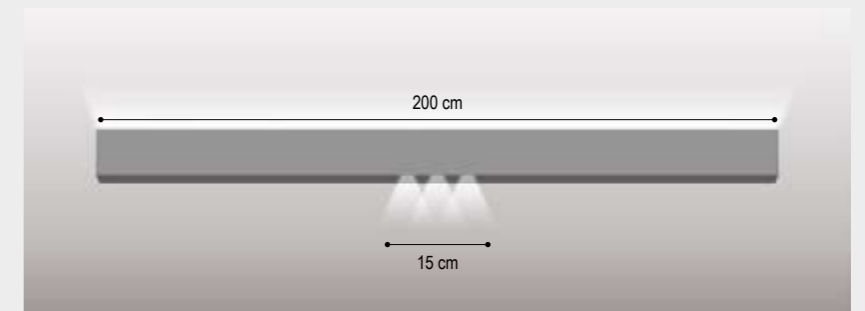

VISTA FRONTALE / FRONT VIEW

ESEMPIO 5 / TYPE 5



VISTA LATERALE / SIDE VIEW

ESEMPIO 6 / TYPE 6

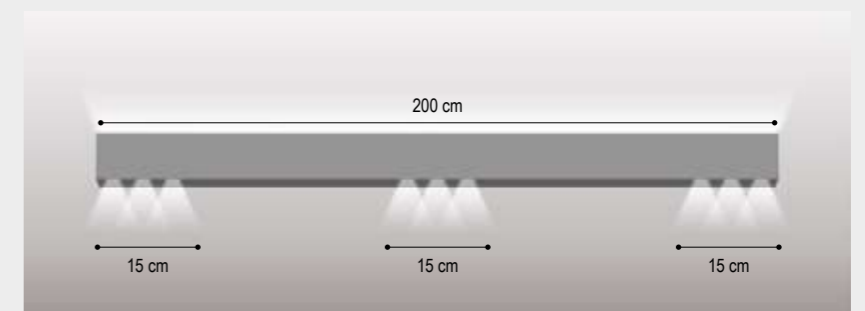

VISTA FRONTALE / FRONT VIEW

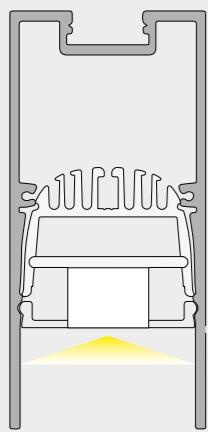

VISTA LATERALE / SIDE VIEW

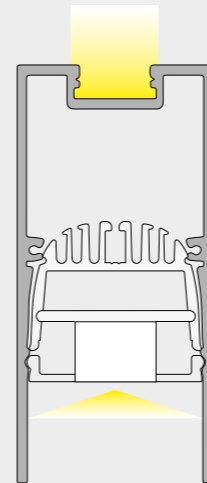

VISTA LATERALE / SIDE VIEW

zero75

led integrato

integrated led

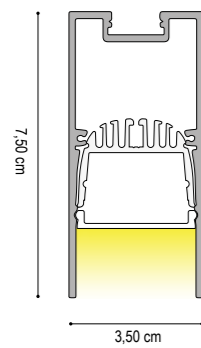

DATI TECNICI
TECHNICAL DATA

	1 cm - 2700K	1 cm - 3000K	1 cm - 4000K
Nominal LED Flux:	2100 lm/m	2200 lm/m	2350 lm/m
Flux Tot:	1680 lm/m	1760 lm/m	1880 lm/m
Output:	105 lm/W	110 lm/W	117 lm/W
CCT:	2700 K	3000 K	4000 K
CRI:	>95	>95	>95
Power Tot:	20.0 W/m	20.0 W/m	20.0 W/m
Weight:	0.90 Kg/m	0.90 Kg/m	0.90 Kg/m

Alluminio/aluminium Cover: Opale/opal

DRIVER NON INCLUSO / NOT INCLUDED

CAVO ALIMENTAZIONE : 50 cm
ALIMENTATION CABLE : 50 cm

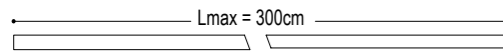

FINITURA STRUTTURA
FINISHES

- GRIGIO VESUVIO ANTHRACITE
- ARGILLA CLAY
- ARGENTO OPACO/MATT SILVER
- BIANCO INTONACO/WHITE
- NERO CARAVAGGIO/BLACK
- MOKA MOCHA
- CROMO/CHROME
- ORO CALIFORNIA/GOLD
- ARAMEN COPPER
- GRIGIO AVIO/ GREY AVIO
- ARGENTO COMETA/SILVER COMET
- OTTONE VENEZIANO/BRASS
- TITANIO/TITANIUM
- BRONZO RIACI/RIACI BRONZE
- VERDE COSTA/GREEN COAST
- TERRA SENESE/SENESE EARTH

DIFFUSORE
DIFFUSER

OPALE/OPAL

	1 cm - 2700K	1 cm - 3000K	1 cm - 4000K
CODICE CODE			
	7525000001	7526000001	7527000001
	7525010001	7526010001	7527010001
	7525020001	7526020001	7527020001
	7525030001	7526030001	7527030001
	7525040001	7526040001	7527040001
	7525050001	7526050001	7527050001
	7525080001	7526080001	7527080001
	7525090001	7526090001	7527090001
	7525100001	7526100001	7527100001
	7525110001	7526110001	7527110001
	7525120001	7526120001	7527120001
	7525130001	7526130001	7527130001
	7525140001	7526140001	7527140001
	7525150001	7526150001	7527150001
	7525160001	7526160001	7527160001
	7525170001	7526170001	7527170001

N.B./P.N.:

LUNGHEZZA MASSIMA VERSIONE CROMO = 2,00 m / MAXIMUM LENGTH CHROME VERSION = 2.00 m
TESTATE NON INCLUSE / DEAD ENDS NOT INCLUDED

zero75 — ugr<19

led integrato

integrated led

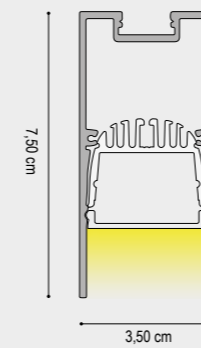

DATI TECNICI
TECHNICAL DATA

	1 cm - 2700K	1 cm - 3000K	1 cm - 4000K
Nominal LED Flux:	2100 lm/m	2200 lm/m	2350 lm/m
Flux Tot:	1890 lm/m	1980 lm/m	2115 lm/m
Output:	105 lm/W	110 lm/W	117 lm/W
CCT:	2700 K	3000 K	4000 K
CRI:	>95	>95	>95
Power Tot:	20.0 W/m	20.0 W/m	20.0 W/m
Weight:	0.90 Kg/m	0.90 Kg/m	0.90 Kg/m

Alluminio/aluminium Cover: Prismaticata/Prismatic

DRIVER NON INCLUSO / NOT INCLUDED

CAVO ALIMENTAZIONE : 50 cm
ALIMENTATION CABLE : 50 cm

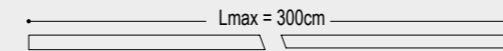

FINITURA STRUTTURA
FINISHES

- GRIGIO VESUVIO ANTHRACITE
- ARGILLA CLAY
- ARGENTO OPACO/MATT SILVER
- BIANCO INTONACO/WHITE
- NERO CARAVAGGIO/BLACK
- MOKA MOCHA
- CROMO/CHROME
- ORO CALIFORNIA/GOLD
- ARAMEN COPPER
- GRIGIO AVIO/ GREY AVIO
- ARGENTO COMETA/SILVER COMET
- OTTONE VENEZIANO/BRASS
- TITANIO/TITANIUM
- BRONZO RIACI/RIACI BRONZE
- VERDE COSTA/GREEN COAST
- TERRA SENESE/SENESE EARTH

DIFFUSORE
DIFFUSER

PRISMATIZZATO
PRISMATIC

	1 cm - 2700K	1 cm - 3000K	1 cm - 4000K
CODICE CODE			
	7525003001	7526003001	7527003001
	7525013001	7526013001	7527013001
	7525023001	7526023001	7527023001
	7525033001	7526033001	7527033001
	7525043001	7526043001	7527043001
	7525053001	7526053001	7527053001
	7525083001	7526083001	7527083001
	7525093001	7526093001	7527093001
	7525103001	7526103001	7527103001
	7525113001	7526113001	7527113001
	7525123001	7526123001	7527123001
	7525133001	7526133001	7527133001
	7525143001	7526143001	7527143001
	7525153001	7526153001	7527153001
	7525163001	7526163001	7527163001
	7525173001	7526173001	7527173001

N.B./P.N.:

LUNGHEZZA MASSIMA VERSIONE CROMO = 2,00 m / MAXIMUM LENGTH CHROME VERSION = 2.00 m
TESTATE NON INCLUSE / DEAD ENDS NOT INCLUDED

zero75

led integrato

integrated led

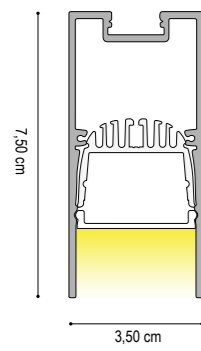

DATI TECNICI
TECHNICAL DATA

	1 cm - 2700K	1 cm - 3000K	1 cm - 4000K
Nominal LED Flux:	2916 lm/m	3024 lm/m	3125 lm/m
Flux Tot:	2333 lm/m	2419 lm/m	2500 lm/m
Output:	135 lm/W	140 lm/W	145 lm/W
CCT:	2700 K	3000 K	4000 K
CRI:	>95	>95	>95
Power Tot:	22 W/m	22 W/m	22 W/m
Weight:	0.90 Kg/m	0.90 Kg	0.90 Kg

Alluminio/aluminium

Cover: Opale/opal

Lmax = 300cm

DRIVER NON INCLUSO / NOT INCLUDED

CAVO ALIMENTAZIONE : 50 cm
ALIMENTATION CABLE : 50 cm

FINITURA STRUTTURA
FINISHES

- GRIGIO VESUVIO ANTHRACITE
- ARGILLA CLAY
- ARGENTO OPACO/MATT SILVER
- BIANCO INTONACO/WHITE
- NERO CARAVAGGIO/BLACK
- MOKA MOCHA
- CROMO/CHROME
- ORO CALIFORNIA/GOLD
- ARAMEN COPPER
- GRIGIO AVIO/GREY AVIO
- ARGENTO COMETA/SILVER COMET
- OTTONE VENEZIANO/BRASS
- TITANIO/TITANIUM
- BRONZO RIACI/RIACI BRONZE
- VERDE COSTA/GREEN COAST
- TERRA SENESE/SENESE EARTH

DIFFUSORE
DIFFUSER

OPALE/OPAL

	1 cm - 2700K	1 cm - 3000K	1 cm - 4000K
CODICE CODE	7586000001	7587000001	7588000001
	7586010001	7587010001	7588010001
	7586020001	7587020001	7588020001
	7586030001	7587030001	7588030001
	7586040001	7587040001	7588040001
	7586050001	7587050001	7588050001
	7586080001	7587080001	7588080001
	7586090001	7587090001	7588090001
	7586100001	7587100001	7588100001
	7586110001	7587110001	7588110001
	7586120001	7587120001	7588120001
	7586130001	7587130001	7588130001
	7586140001	7587140001	7588140001
	7586150001	7587150001	7588150001
	7586160001	7587160001	7588160001
	7586170001	7587170001	7588170001

N.B./P.N.:
LUNGHEZZA MASSIMA VERSIONE CROMO = 2,00 m / MAXIMUM LENGTH CHROME VERSION = 2.00 m
TESTATE NON INCLUSE / DEAD ENDS NOT INCLUDED

zero75 — ugr<19

led integrato

integrated led

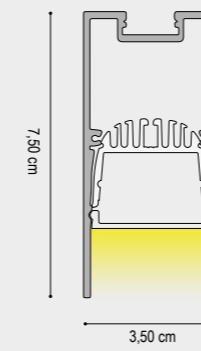

DATI TECNICI
TECHNICAL DATA

	1 cm - 2700K	1 cm - 3000K	1 cm - 4000K
Nominal LED Flux:	2916 lm/m	3024 lm/m	3125 lm/m
Flux Tot:	2624 lm/m	2722 lm/m	2812 lm/m
Output:	135 lm/W	140 lm/W	145 lm/W
CCT:	2700 K	3000 K	4000 K
CRI:	>95	>95	>95
Power Tot:	22 W/m	22 W/m	22 W/m
Weight:	0.90 Kg/m	0.90 Kg	0.90 Kg

Alluminio/aluminium

Cover: Prismaticata/Prismatic

Lmax = 300cm

DRIVER NON INCLUSO / NOT INCLUDED

CAVO ALIMENTAZIONE : 50 cm
ALIMENTATION CABLE : 50 cm

FINITURA STRUTTURA
FINISHES

- GRIGIO VESUVIO ANTHRACITE
- ARGILLA CLAY
- ARGENTO OPACO/MATT SILVER
- BIANCO INTONACO/WHITE
- NERO CARAVAGGIO/BLACK
- MOKA MOCHA
- CROMO/CHROME
- ORO CALIFORNIA/GOLD
- ARAMEN COPPER
- GRIGIO AVIO/GREY AVIO
- ARGENTO COMETA/SILVER COMET
- OTTONE VENEZIANO/BRASS
- TITANIO/TITANIUM
- BRONZO RIACI/RIACI BRONZE
- VERDE COSTA/GREEN COAST
- TERRA SENESE/SENESE EARTH

DIFFUSORE
DIFFUSER

PRISMATIZZATO
PRISMATIC

	1 cm - 2700K	1 cm - 3000K	1 cm - 4000K
CODICE CODE	7586003001	7587003001	7588003001
	7586013001	7587013001	7588013001
	7586023001	7587023001	7588023001
	7586033001	7587033001	7588033001
	7586043001	7587043001	7588043001
	7586053001	7587053001	7588053001
	7586083001	7587083001	7588083001
	7586093001	7587093001	7588093001
	7586103001	7587103001	7588103001
	7586113001	7587113001	7588113001
	7586123001	7587123001	7588123001
	7586133001	7587133001	7588133001
	7586143001	7587143001	7588143001
	7586153001	7587153001	7588153001
	7586163001	7587163001	7588163001
	7586173001	7587173001	7588173001

N.B./P.N.:
LUNGHEZZA MASSIMA VERSIONE CROMO = 2,00 m / MAXIMUM LENGTH CHROME VERSION = 2.00 m
TESTATE NON INCLUSE / DEAD ENDS NOT INCLUDED

zero75

led integrato

integrated led

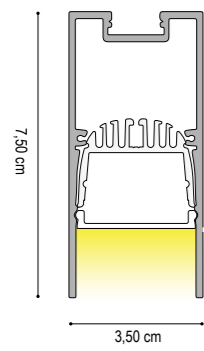

DATI TECNICI
TECHNICAL DATA

	1 cm - 2700K	1 cm - 3000K	1 cm - 4000K
Nominal LED Flux:	3750 lm/m	3900 lm/m	4050 lm/m
Flux Tot:	3120 lm/m	3240 lm/m	3570 lm/m
Output:	125 lm/W	130 lm/W	135 lm/W
CCT:	2700 K	3000 K	4000 K
CRI:	>90	>90	>90
Power Tot:	30.0 W/m	30.0 W/m	30.0 W/m
Weight:	0.90 Kg/m	0.90 Kg/m	0.90 Kg/m

Alluminio/aluminium

Cover: Opale/opal

Lmax = 300cm

DRIVER NON INCLUSO / NOT INCLUDED

CAVO ALIMENTAZIONE : 50 cm
ALIMENTATION CABLE : 50 cm

FINITURA STRUTTURA
FINISHES

- GRIGIO VESUVIO ANTHRACITE
- ARGILLA CLAY
- ARGENTO OPACO/MATT SILVER
- BIANCO INTONACO/WHITE
- NERO CARAVAGGIO/BLACK
- MOKA MOCHA
- CROMO CHROME
- ORO CALIFORNIA/GOLD
- ARAMEN COPPER
- GRIGIO AVIO/GREY AVIO
- ARGENTO COMETA/SILVER COMET
- OTTONE VENEZIANO BRASS
- TITANIO/TITANIUM
- BRONZO RIACIRIACI BRONZE
- VERDE COSTA/GREEN COAST
- TERRA SENESE SENESE EARTH

DIFFUSORE
DIFFUSER

OPALE/OPAL

	1 cm - 2700K	1 cm - 3000K	1 cm - 4000K
CODICE CODE	758000001	758100001	758200001
	758001001	758101001	758201001
	758002001	758102001	758202001
	758003001	758103001	758203001
	758004001	758104001	758204001
	758005001	758105001	758205001
	758008001	758108001	758208001
	758009001	758109001	758209001
	758010001	758110001	758210001
	758011001	758111001	758211001
	758012001	758112001	758212001
	758013001	758113001	758213001
	758014001	758114001	758214001
	758015001	758115001	758215001
	758016001	758116001	758216001
	758017001	758117001	758217001

N.B./P.N.:
LUNGHEZZA MASSIMA VERSIONE CROMO = 2,00 m / MAXIMUM LENGTH CHROME VERSION = 2.00 m
TESTATE NON INCLUSE / DEAD ENDS NOT INCLUDED

zero75 — ugr<19

led integrato

integrated led

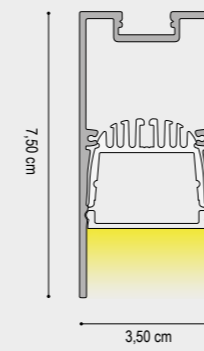

DATI TECNICI
TECHNICAL DATA

	1 cm - 2700K	1 cm - 3000K	1 cm - 4000K
Nominal LED Flux:	3900 lm/m	4050 lm/m	4200 lm/m
Flux Tot:	3375 lm/m	3510 lm/m	3645 lm/m
Output:	130 lm/W	135 lm/W	140 lm/W
CCT:	2700 K	3000 K	4000 K
CRI:	>90	>90	>90
Power Tot:	30.0 W/m	30.0 W/m	30.0 W/m
Weight:	0.90 Kg/m	0.90 Kg/m	0.90 Kg/m

Alluminio/aluminium

Cover: Prismatizzata/Prismatic

Lmax = 300cm

DRIVER NON INCLUSO / NOT INCLUDED

CAVO ALIMENTAZIONE : 50 cm
ALIMENTATION CABLE : 50 cm

FINITURA STRUTTURA
FINISHES

- GRIGIO VESUVIO ANTHRACITE
- ARGILLA CLAY
- ARGENTO OPACO/MATT SILVER
- BIANCO INTONACO/WHITE
- NERO CARAVAGGIO/BLACK
- MOKA MOCHA
- CROMO CHROME
- ORO CALIFORNIA/GOLD
- ARAMEN COPPER
- GRIGIO AVIO/GREY AVIO
- ARGENTO COMETA/SILVER COMET
- OTTONE VENEZIANO BRASS
- TITANIO/TITANIUM
- BRONZO RIACIRIACI BRONZE
- VERDE COSTA/GREEN COAST
- TERRA SENESE SENESE EARTH

DIFFUSORE
DIFFUSER

PRISMATIZZATO
PRISMATIC

	1 cm - 2700K	1 cm - 3000K	1 cm - 4000K
CODICE CODE	7580003001	7581003001	7582003001
	7580013001	7581013001	7582013001
	7580023001	7581023001	7582023001
	7580033001	7581033001	7582033001
	7580043001	7581043001	7582043001
	7580053001	7581053001	7582053001
	7580083001	7581083001	7582083001
	7580093001	7581093001	7582093001
	7580103001	7581103001	7582103001
	7580113001	7581113001	7582113001
	7580123001	7581123001	7582123001
	7580133001	7581133001	7582133001
	7580143001	7581143001	7582143001
	7580153001	7581153001	7582153001
	7580163001	7581163001	7582163001
	7580173001	7581173001	7582173001

N.B./P.N.:
LUNGHEZZA MASSIMA VERSIONE CROMO = 2,00 m / MAXIMUM LENGTH CHROME VERSION = 2.00 m
TESTATE NON INCLUSE / DEAD ENDS NOT INCLUDED

zero75 x

led integrato

integrated led

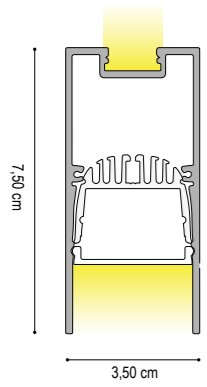

DATI TECNICI
TECHNICAL DATA

	1 cm - 2700K	1 cm - 3000K	1 cm - 4000K
Nominal LED Flux:	↑ 1440 lm - 2100 lm ↓	↑ 1490 lm - 2200 lm ↓	↑ 1540 lm - 2350 lm/m ↓
Flux Tot:	↑ 1152 lm - 1680 lm ↓	↑ 1202 lm - 1760 lm ↓	↑ 1252 lm - 1880 lm/m ↓
Output:	↑ 100 lm/W - 105 lm/W ↓	↑ 105 lm/W - 110 lm/W ↓	↑ 110 lm/W - 117 lm/W ↓
CCT:	2700 K	3000 K	4000 K
CRI:	>95	>95	>95
Power:	↑ 14,4W - 20W ↓	↑ 14,4W - 20W ↓	↑ 14,4W - 20W ↓
Power Tot:	35.0 W/m	35.0 W/m	35.0 W/m
Weight:	0.90 Kg/m	0.90 Kg/m	0.90 Kg/m

Alluminio/aluminium Cover: Opale/opal
Satinata/Satin

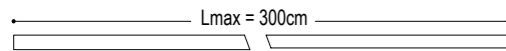

DRIVER NON INCLUSO / NOT INCLUDED

CAVO ALIMENTAZIONE : 50 cm
ALIMENTATION CABLE : 50 cm

FINITURA STRUTTURA
FINISHES

- GRIGIO VESUVIO ANTHRACITE
- ARGILLA CLAY
- ARGENTO OPACO/MATT SILVER
- BIANCO INTONACO/WHITE
- NERO CARAVAGGIO/BLACK
- MOKA MOCHA
- CROMO/CHROME
- ORO CALIFORNIA/GOLD
- ARAMEN COPPER
- GRIGIO AVIO/GREY AVIO
- ARGENTO COMETA/SILVER COMET
- OTTONE VENEZIANO/BRASS
- TITANIO/TITANIUM
- BRONZO RIACI/RIACI BRONZE
- VERDE COSTA/GREEN COAST
- TERRA SENESE/SENESE EARTH

DIFFUSORE
DIFFUSER

- TRASPARENTE
TRANSPARENT
- OPALE/OPAL

	1 cm - 2700K	1 cm - 3000K	1 cm - 4000K
CODICE CODE	75X2500001	75X2600001	75X2700001
	75X2501001	75X2601001	75X2701001
	75X2502001	75X2602001	75X2702001
	75X2503001	75X2603001	75X2703001
	75X2504001	75X2604001	75X2704001
	75X2505001	75X2605001	75X2705001
	75X2508001	75X2608001	75X2708001
	75X2509001	75X2609001	75X2709001
	75X2510001	75X2610001	75X2710001
	75X2511001	75X2611001	75X2711001
	75X2512001	75X2612001	75X2712001
	75X2513001	75X2613001	75X2713001
	75X2514001	75X2614001	75X2714001
	75X2515001	75X2615001	75X2715001
	75X2516001	75X2616001	75X2716001
	75X2517001	75X2617001	75X2717001

N.B./P.N.:
LUNGHEZZA MASSIMA VERSIONE CROMO = 2,00 m / MAXIMUM LENGTH CHROME VERSION = 2.00 m
TESTATE NON INCLUSE / DEAD ENDS NOT INCLUDED

zero75 x — ugr<19

led integrato

integrated led

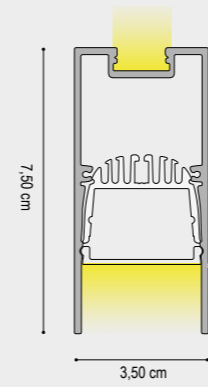

DATI TECNICI
TECHNICAL DATA

	1 cm - 2700K	1 cm - 3000K	1 cm - 4000K
Nominal LED Flux:	↑ 1440 lm - 2100 lm ↓	↑ 1440 lm - 2200 lm ↓	↑ 1440 lm - 2350 lm/m ↓
Flux Tot:	↑ 1296 lm - 1890 lm ↓	↑ 1296 lm - 1980 lm ↓	↑ 1296 lm - 2115 lm/m ↓
Output:	↑ 100 lm/W - 105 lm/W ↓	↑ 105 lm/W - 110 lm/W ↓	↑ 110 lm/W - 117 lm/W ↓
CCT:	2700 K	W 3000 K	4000 K
CRI:	>95	>95	>95
Power:	↑ 14,4W - 20W ↓	↑ 14,4W - 20W ↓	↑ 14,4W - 20W ↓
Power Tot:	35.0 W/m	35.0 W/m	35.0 W/m
Weight:	0.90 Kg/m	0.90 Kg/m	0.90 Kg/m

Alluminio/aluminium Cover: Prismaticata/Prismatic
Satinata/Satin

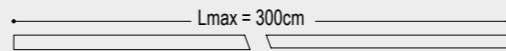

DRIVER NON INCLUSO / NOT INCLUDED

CAVO ALIMENTAZIONE : 50 cm
ALIMENTATION CABLE : 50 cm

FINITURA STRUTTURA
FINISHES

- GRIGIO VESUVIO ANTHRACITE
- ARGILLA CLAY
- ARGENTO OPACO/MATT SILVER
- BIANCO INTONACO/WHITE
- NERO CARAVAGGIO/BLACK
- MOKA MOCHA
- CROMO/CHROME
- ORO CALIFORNIA/GOLD
- ARAMEN COPPER
- GRIGIO AVIO/GREY AVIO
- ARGENTO COMETA/SILVER COMET
- OTTONE VENEZIANO/BRASS
- TITANIO/TITANIUM
- BRONZO RIACI/RIACI BRONZE
- VERDE COSTA/GREEN COAST
- TERRA SENESE/SENESE EARTH

DIFFUSORE
DIFFUSER

- TRASPARENTE
TRANSPARENT
- PRISMATIZZATO
PRISMATIC

	1 cm - 2700K	1 cm - 3000K	1 cm - 4000K
CODICE CODE	75X2500301	75X2600301	75X2700301
	75X2501301	75X2601301	75X2701301
	75X2502301	75X2602301	75X2702301
	75X2503301	75X2603301	75X2703301
	75X2504301	75X2604301	75X2704301
	75X2505301	75X2605301	75X2705301
	75X2508301	75X2608301	75X2708301
	75X2509301	75X2609301	75X2709301
	75X2510301	75X2610301	75X2710301
	75X2511301	75X2611301	75X2711301
	75X2512301	75X2612301	75X2712301
	75X2513301	75X2613301	75X2713301
	75X2514301	75X2614301	75X2714301
	75X2515301	75X2615301	75X2715301
	75X2516301	75X2616301	75X2716301
	75X2517301	75X2617301	75X2717301

N.B./P.N.:
LUNGHEZZA MASSIMA VERSIONE CROMO = 2,00 m / MAXIMUM LENGTH CHROME VERSION = 2.00 m
TESTATE NON INCLUSE / DEAD ENDS NOT INCLUDED

zero75 x

led integrato

integrated led

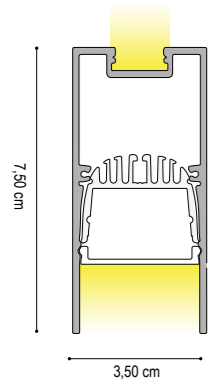

DATI TECNICI
TECHNICAL DATA

	1 cm - 2700K	1 cm - 3000K	1 cm - 4000K
Nominal LED Flux:	↑ 1440 lm - 2916 lm ↓	↑ 1490 lm - 3024lm ↓	↑ 1540 lm - 3125 lm ↓
Flux Tot:	↑ 1152 lm - 2333 lm/m ↓	↑ 1202 lm - 2419 lm/m ↓	↑ 1252 lm - 2500 lm/m ↓
Output:	↑ 100 - 135 lm/W ↓	↑ 100 - 140 lm/W ↓	↑ 100 - 145 lm/W ↓
CCT:	2700 K	3000 K	4000 K
CRI:	>95	>95	>95
Power:	↑ 14,4W - 21,6W ↓	↑ 14,4W - 21,6W ↓	↑ 14,4W - 21,6W ↓
Power Tot:	36 W/m	36 W/m	36 W/m
Weight:	0.90 Kg/m	0.90 Kg	0.90 Kg

Alluminio/aluminium Cover: Opale/opal
Satinata/Satin

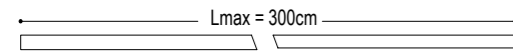

DRIVER NON INCLUSO / NOT INCLUDED

CAVO ALIMENTAZIONE : 50 cm
ALIMENTATION CABLE : 50 cm

FINITURA STRUTTURA
FINISHES

- GRIGIO VESUVIO ANTHRACITE
- ARGILLA CLAY
- ARGENTO OPACO/MATT SILVER
- BIANCO INTONACO/WHITE
- NERO CARAVAGGIO/BLACK
- MOKA MOCHA
- CROMO/CHROME
- ORO CALIFORNIA/GOLD
- ARAMEN COPPER
- GRIGIO AVIO/GREY AVIO
- ARGENTO COMETA/SILVER COMET
- OTTONE VENEZIANO/BRASS
- TITANIO/TITANIUM
- BRONZO RIACIRIACI/BRONZE
- VERDE COSTA/GREEN COAST
- TERRA SENESE/SENESE EARTH

DIFFUSORE
DIFFUSER

- TRASPARENTE
TRANSPARENT
- OPALE/OPAL

	1 cm - 2700K	1 cm - 3000K	1 cm - 4000K
CODICE CODE	75X8600001	75X8700001	75X8800001
	75X8601001	75X8701001	75X8801001
	75X8602001	75X8702001	75X8802001
	75X8603001	75X8703001	75X8803001
	75X8604001	75X8704001	75X8804001
	75X8605001	75X8705001	75X8805001
	75X8608301	75X8708301	75X8808301
	75X8609001	75X8709001	75X8809001
	75X8610001	75X8710001	75X8810001
	75X8611001	75X8711001	75X8811001
	75X8612001	75X8712001	75X8812001
	75X8613001	75X8713001	75X8813001
	75X8614001	75X8714001	75X8814001
	75X8615001	75X8715001	75X8815001
	75X8616001	75X8716001	75X8816001
	75X8617001	75X8717001	75X8817001

N.B./P.N.:
LUNGHEZZA MASSIMA VERSIONE CROMO = 2,00 m / MAXIMUM LENGTH CHROME VERSION = 2.00 m
TESTATE NON INCLUSE / DEAD ENDS NOT INCLUDED

zero75 x — ugr<19

led integrato

integrated led

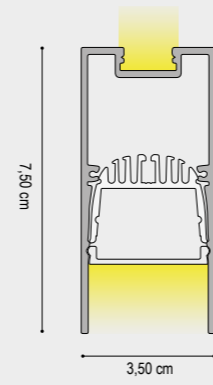

DATI TECNICI
TECHNICAL DATA

	1 cm - 2700K	1 cm - 3000K	1 cm - 4000K
Nominal LED Flux:	↑ 1440 lm - 2916 lm ↓	↑ 1490 lm - 3024 lm ↓	↑ 1540 lm - 3125 lm ↓
Flux Tot:	↑ 1152 lm - 2333 lm/m ↓	↑ 1202 lm - 2419 lm/m ↓	↑ 1252 lm - 2500 lm/m ↓
Output:	↑ 100 - 135 lm/W ↓	↑ 100 - 135 lm/W ↓	↑ 100 - 135 lm/W ↓
CCT:	2700 K	3000 K	4000 K
CRI:	>95	>95	>95
Power:	↑ 14,4W - 21,6W ↓	↑ 14,4W - 21,6W ↓	↑ 14,4W - 21,6W ↓
Power Tot:	36 W/m	36 W/m	36 W/m
Weight:	0.90 Kg/m	0.90 Kg	0.90 Kg

Alluminio/aluminium Cover: Prismatizzata/Prismatic

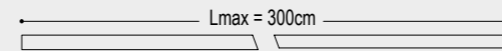

DRIVER NON INCLUSO / NOT INCLUDED

CAVO ALIMENTAZIONE : 50 cm
ALIMENTATION CABLE : 50 cm

FINITURA STRUTTURA
FINISHES

- GRIGIO VESUVIO ANTHRACITE
- ARGILLA CLAY
- ARGENTO OPACO/MATT SILVER
- BIANCO INTONACO/WHITE
- NERO CARAVAGGIO/BLACK
- MOKA MOCHA
- CROMO/CHROME
- ORO CALIFORNIA/GOLD
- ARAMEN COPPER
- GRIGIO AVIO/GREY AVIO
- ARGENTO COMETA/SILVER COMET
- OTTONE VENEZIANO/BRASS
- TITANIO/TITANIUM
- BRONZO RIACIRIACI/BRONZE
- VERDE COSTA/GREEN COAST
- TERRA SENESE/SENESE EARTH

DIFFUSORE
DIFFUSER

- TRASPARENTE
TRANSPARENT
- PRISMATIZZATO
PRISMATIC

	1 cm - 2700K	1 cm - 3000K	1 cm - 4000K
CODICE CODE	75X8600301	75X8700301	75X8800301
	75X8601301	75X8701301	75X8801301
	75X8602301	75X8702301	75X8802301
	75X8603301	75X8703301	75X8803301
	75X8604301	75X8704301	75X8804301
	75X8605301	75X8705301	75X8805301
	75X8608301	75X8708301	75X8808301
	75X8609301	75X8709301	75X8809301
	75X8610301	75X8710301	75X8810301
	75X8611301	75X8711301	75X8811301
	75X8612301	75X8712301	75X8812301
	75X8613301	75X8713301	75X8813301
	75X8614301	75X8714301	75X8814301
	75X8615301	75X8715301	75X8815301
	75X8616301	75X8716301	75X8816301
	75X8617301	75X8717301	75X8817301

N.B./P.N.:
LUNGHEZZA MASSIMA VERSIONE CROMO = 2,00 m / MAXIMUM LENGTH CHROME VERSION = 2.00 m
TESTATE NON INCLUSE / DEAD ENDS NOT INCLUDED

zero75 x

led integrato

integrated led

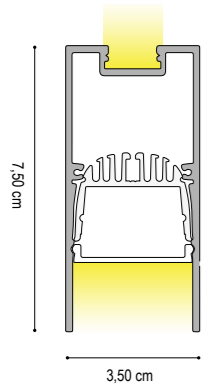

DATI TECNICI
TECHNICAL DATA

	1 cm - 2700K	1 cm - 3000K	1 cm - 4000K
Nominal LED Flux:	↑ 1440 lm/m - 3750 lm/m ↓	↑ 1440 lm/m - 3900 lm/m ↓	↑ 1440 lm/m - 4050 lm/m ↓
Flux Tot:	↑ 1152 lm/m - 3120 lm/m ↓	↑ 1152 lm/m - 3240 lm/m ↓	↑ 1152 lm/m - 3570 lm/m ↓
Output:	↑ 100 lm/W - 130 lm/W ↓	↑ 100 lm/W - 1130 lm/W ↓	↑ 100 lm/W - 1135 lm/W ↓
CCT:	2700 K	3000 K	4000 K
CRI:	>95	>95	>95
Power:	↑ 15W - 30W ↓	↑ 15W - 30W ↓	↑ 15W - 30W ↓
Power Tot:	45 W/m	45 W/m	45 W/m
Weight:	0.90 Kg/m	0.90 Kg	0.90 Kg

Alluminio/aluminium Cover: Opale/opal
Satinata/Satin

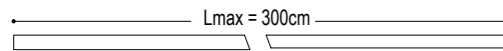

DRIVER NON INCLUSO / NOT INCLUDED

CAVO ALIMENTAZIONE : 50 cm
ALIMENTATION CABLE : 50 cm

FINITURA STRUTTURA
FINISHES

- GRIGIO VESUVIO ANTHRACITE
- ARGILLA CLAY
- ARGENTO OPACO/MATT SILVER
- BIANCO INTONACO/WHITE
- NERO CARAVAGGIO/BLACK
- MOKA MOCHA
- CROMO/CHROME
- ORO CALIFORNIA/GOLD
- ARAMEN COPPER
- GRIGIO AVIO/GREY AVIO
- ARGENTO COMETA/SILVER COMET
- OTTONE VENEZIANO/BRASS
- TITANIO/TITANIUM
- BRONZO RIACI/RIACI BRONZE
- VERDE COSTA/GREEN COAST
- TERRA SENESE/SENESE EARTH

DIFFUSORE
DIFFUSER

- TRASPARENTE
TRANSPARENT
- OPALE/OPAL

	1 cm - 2700K	1 cm - 3000K	1 cm - 4000K
CODICE CODE	75X8000001	75X8100001	75X8200001
	75X8001001	75X8101001	75X8201001
	75X8002001	75X8102001	75X8202001
	75X8003001	75X8103001	75X8203001
	75X8004001	75X8104001	75X8204001
	75X8005001	75X8105001	75X8205001
	75X8008001	75X8108001	75X8208001
	75X8009001	75X8109001	75X8209001
	75X8010001	75X8110001	75X8210001
	75X8011001	75X8111001	75X8211001
	75X8012001	75X8112001	75X8212001
	75X8013001	75X8113001	75X8213001
	75X8014001	75X8114001	75X8214001
	75X8015001	75X8115001	75X8215001
	75X8016001	75X8116001	75X8216001
	75X8017001	75X8117001	75X8217001

N.B./P.N.:
LUNGHEZZA MASSIMA VERSIONE CROMO = 2,00 m / MAXIMUM LENGTH CHROME VERSION = 2.00 m
TESTATE NON INCLUSE / DEAD ENDS NOT INCLUDED

zero75 x — ugr<19

led integrato

integrated led

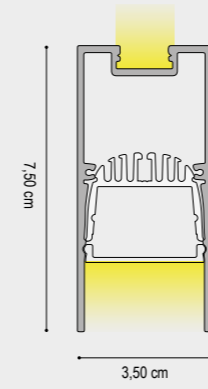

DATI TECNICI
TECHNICAL DATA

	1 cm - 2700K	1 cm - 3000K	1 cm - 4000K
Nominal LED Flux:	↑ 1440 lm/m - 3750 lm/m ↓	↑ 1440 lm/m - 3900 lm/m ↓	↑ 1440 lm/m - 4050 lm/m ↓
Flux Tot:	↑ 1296 lm/m - 3375 lm/m ↓	↑ 1296 lm/m - 3510 lm/m ↓	↑ 1296 lm/m - 3645 lm/m ↓
Output:	↑ 100 lm/W - 125 lm/W ↓	↑ 100 lm/W - 130 lm/W ↓	↑ 100 lm/W - 135 lm/W ↓
CCT:	2700 K	3000 K	4000 K
CRI:	>95	>95	>95
Power:	↑ 15W - 30W ↓	↑ 15W - 30W ↓	↑ 15W - 30W ↓
Power Tot:	45 W/m	45 W/m	45 W/m
Weight:	0.90 Kg/m	0.90 Kg	0.90 Kg

Alluminio/aluminium Cover: Opale/opal
Satinata/Satin

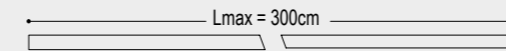

DRIVER NON INCLUSO / NOT INCLUDED

CAVO ALIMENTAZIONE : 50 cm
ALIMENTATION CABLE : 50 cm

FINITURA STRUTTURA
FINISHES

- GRIGIO VESUVIO ANTHRACITE
- ARGILLA CLAY
- ARGENTO OPACO/MATT SILVER
- BIANCO INTONACO/WHITE
- NERO CARAVAGGIO/BLACK
- MOKA MOCHA
- CROMO/CHROME
- ORO CALIFORNIA/GOLD
- ARAMEN COPPER
- GRIGIO AVIO/GREY AVIO
- ARGENTO COMETA/SILVER COMET
- OTTONE VENEZIANO/BRASS
- TITANIO/TITANIUM
- BRONZO RIACI/RIACI BRONZE
- VERDE COSTA/GREEN COAST
- TERRA SENESE/SENESE EARTH

DIFFUSORE
DIFFUSER

- TRASPARENTE
TRANSPARENT
- PRISMATIZZATO
PRISMATIC

	1 cm - 2700K	1 cm - 3000K	1 cm - 4000K
CODICE CODE	75X8000301	75X8100301	75X8200301
	75X8001301	75X8101301	75X8201301
	75X8002301	75X8102301	75X8202301
	75X8003301	75X8103301	75X8203301
	75X8004301	75X8104301	75X8204301
	75X8005301	75X8105301	75X8205301
	75X8008301	75X8108301	75X8208301
	75X8009301	75X8109301	75X8209301
	75X8010301	75X8110301	75X8210301
	75X8011301	75X8111301	75X8211301
	75X8012301	75X8112301	75X8212301
	75X8013301	75X8113301	75X8213301
	75X8014301	75X8114301	75X8214301
	75X8015301	75X8115301	75X8215301
	75X8016301	75X8116301	75X8216301
	75X8017301	75X8117301	75X8217301

N.B./P.N.:
LUNGHEZZA MASSIMA VERSIONE CROMO = 2,00 m / MAXIMUM LENGTH CHROME VERSION = 2.00 m
TESTATE NON INCLUSE / DEAD ENDS NOT INCLUDED



zero75 xp



zero75 xp

ZER075X-P CON DIFFUSORE ESTERNO
ZER075X-P WITH EXTERNAL DIFFUSER

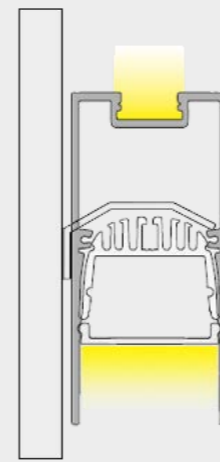

INSTALLAZIONE STAFFA A PARETE WALL BRACKET INSTALLATION

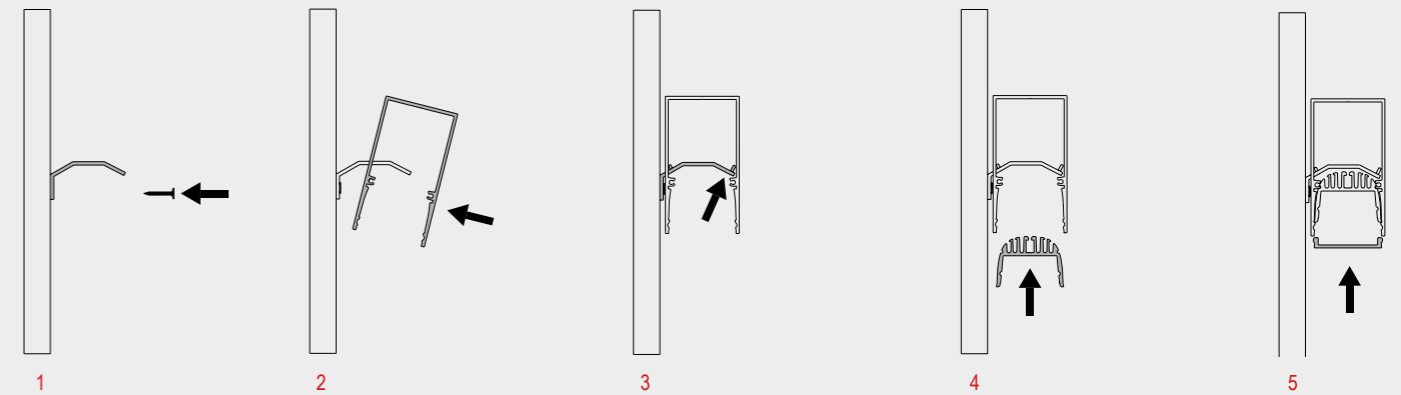

1. FISSARE LE STAFFE UTILIZZANDO SISTEMI DI FISSAGGIO IDONEI AL TIPO DI PARETE. PRESTARE ATTENZIONE ALL'ALLINEAMENTO DELLE STAFFE PER UNA CORRETTA INSTALLAZIONE DEL PRODOTTO. IN CASO DI INSTALLAZIONE SU PARETE NON LINEARE, SI CONSIGLIA DI UTILIZZARE SUPPORTI DISTANZIALI AL FINE DI EVITARNE LA TORSIONE.

1. FIX THE BRACKETS USING FASTENING SYSTEMS SUITABLE FOR THE TYPE OF WALL. PAY ATTENTION TO THE ALIGNMENT OF THE BRACKETS FOR A CORRECT INSTALLATION OF THE PRODUCT. IN THE EVENT OF INSTALLATION ON A NON-LINEAR WALL, IT IS RECOMMENDED TO USE SPACER SUPPORTS IN ORDER TO AVOID TORSION.

2. SUL LATO DEL PROFILO RIVOLTO VERSO LA PARETE È PRESENTE UN'ASOLA. INSERIRE LA STAFFA NELL'ASOLA.

2. THERE IS A SLOT ON THE SIDE OF THE PROFILE FACING THE WALL. INSERT THE BRACKET IN THE SLOT.

3. BLOCCARE IL PROFILO ALLA STAFFA UTILIZZANDO GLI APPOSITI GRANI FILETTATI.

3. LOCK THE PROFILE TO THE BRACKET USING THE SPECIAL THREADED DOWELS.

4. INSERIRE IL DISSIPATORE IN ALLUMINIO. ATTENZIONE! ASSICURARSI DEL PERFETTO SCATTO TRA IL DISSIPATORE E IL PROFILO. UN'INSTALLAZIONE ERRATA PUÒ COMPROMETTERE LA TENUTA E LA DURABILITÀ DEL PRODOTTO.

4. INSERT THE ALUMINUM HEAT SINK. WARNING! MAKE SURE THE PERFECT SNAP BETWEEN THE HEAT SINK AND THE PROFILE. AN INCORRECT INSTALLATION MAY COMPROMISE THE SEALING AND DURABILITY OF THE PRODUCT.

5. INSERIRE LA COVER IN POLICARBONATO.

5. INSERT THE POLYCARBONATE COVER.

configurazioni

configurations



A. COMPOSIZIONE ANGOLARE A "L"
A. L-ANGLE COMPOSITION

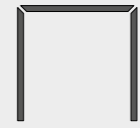

B. COMPOSIZIONE ANGOLARE A "C"
B. C-ANGLE COMPOSITION

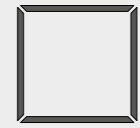

C. COMPOSIZIONE POLIGONALE (QUADRATO/RETTANGOLO)
C. POLYGONAL COMPOSITION (SQUARE / RECTANGLE)

DATI TECNICI
TECHNICAL DATA

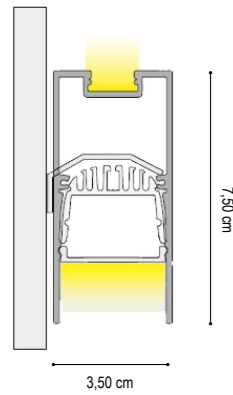

	DIFFUSORE PRISMATIZZATO / PRISMATIC DIFFUSER		
	1 cm - 40W/m	1 cm - 40W	1 cm - 40W
Nominal LED Flux:	↑ 2100 lm/m - 2100 lm/m ↓	↑ 2200 lm/m - 2200 lm/m ↓	↑ 2300 lm - 2300 lm/m ↓
Flux Tot:	↑ 1680 lm/m - 1680 lm/m ↓	↑ 1780 lm - 1780lm ↓	↑ 1880 lm - 10656 lm/m ↓
Output:	105 lm/W	110 lm/W	115 lm/W
CCT:	2700 K	3000 K	4000 K
CRI:	>95	>95	>95
Power:	↑ 20.0W/m - 20.0W/m ↓	↑ 20.0W - 20.0W ↓	↑ 90.0W - 90.0W ↓
Power Tot:	40.0W/m	40.0W/m	40.0W/m
Weight:	1.40 Kg/m	2.80 Kg	4.20 Kg

Alluminio/aluminium

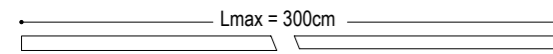

DRIVER NON INCLUSO / NOT INCLUDED

CAVO ALIMENTAZIONE : 50 cm
ALIMENTATION CABLE : 50 cm

FINITURA STRUTTURA FINISHES	DIFFUSORE DIFFUSER	1 cm - 2700K	1 cm - 3000K	1 cm - 4000K
		CODICE CODE	CODICE CODE	CODICE CODE
GRIGIO VESUVIO ANTHRACITE		75X2500041	75X2600041	75X2700041
ARGILLA CLAY		75X2501041	75X2601041	75X2701041
ARGENTO OPACO MATT SILVER		75X2502041	75X2602041	75X2702041
BIANCO INTONACO/WHITE		75X2503041	75X2603041	75X2703041
NERO CARAVAGGIO/BLACK		75X2504041	75X2604041	75X2704041
MOKA MOCHA		75X2605041	75X2605041	75X2705041
ORO CALIFORNIA/GOLD		75X2509041	75X2609041	75X2709041
ARAMEN COPPER	OPALE/OPAL	75X2510041	75X2610041	75X2710041
GRIGIO AVIO/GREY AVIO	OPALE/OPAL	75X2511041	75X2611041	75X2711041
ARGENTO COMETA/SILVER COMET		75X2512041	75X2612041	75X2712041
OTTONE VENEZIANO/BRASS		75X2513041	75X2613041	75X2713041
TITANIO/TITANIUM		75X2514041	75X2614041	75X2714041
BRONZO RIACI/RIACI BRONZE		75X2515041	75X2615041	75X2715041
VERDE COSTA/GREEN COAST		75X2516041	75X2616041	75X2716041
TERRA SENESE SENESE EARTH		75X2517041	75X2617041	75X2717041
CROMO/CHROME		75X2508041	75X2608041	75X2708041

N.B./P.N.:

LUNGHEZZA MASSIMA VERSIONE CROMO = 2,00 m / MAXIMUM LENGTH CHROME VERSION = 2.00 m

TESTATE NON INCLUSE / DEAD ENDS NOT INCLUDED

IL DISSIPATORE INTERNO VIENE FORNITO DI SERIE IN FINITURA ALLUMINIO NATURALE / THE EXTERNAL HEATSINK IS SUPPLIED AS STANDARD IN A NATURAL ALUMINIUM FINISH

DATI TECNICI
TECHNICAL DATA

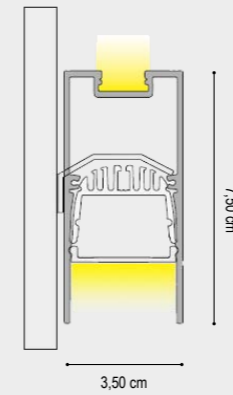

	DIFFUSORE PRISMATIZZATO / PRISMATIC DIFFUSER		
	1 cm - 60W/m	1 cm - 60W/m	1 cm - 60W/m
Nominal LED Flux:	↑ 3900 lm/m - 3900 lm/m ↓	↑ 4050 lm - 4050 lm ↓	↑ 4200 lm - 4200 lm ↓
Flux Tot:	↑ 3120 lm/m - 3120 lm/m ↓	↑ 3240 lm - 3240 lm ↓	↑ 3570 lm - 3700 lm ↓
Output:	130 lm/W	135 lm/W	140 lm/W
CCT:	2700 K	3000 K	4000 K
CRI:	>95	>95	>95
Power:	↑ 30.0W/m - 30.0W/m ↓	↑ 30.0W - 30.0W ↓	↑ 30.0W - 30.0W ↓
Power Tot:	60.0W/m	60.0W/m	60.0W/m
Weight:	1.40 Kg/m	2.80 Kg	4.20 Kg

Alluminio/aluminium

Cover: Prismatizzato/prismatic - Satinato/Satin

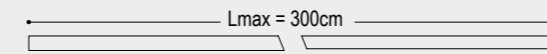

DRIVER NON INCLUSO / NOT INCLUDED

CAVO ALIMENTAZIONE : 50 cm
ALIMENTATION CABLE : 50 cm

FINITURA STRUTTURA FINISHES	DIFFUSORE DIFFUSER	1 cm - 2700K	1 cm - 3000K	1 cm - 4000K
		CODICE CODE	CODICE CODE	CODICE CODE
GRIGIO VESUVIO ANTHRACITE		75X8000041	75X8100041	75X8200041
ARGILLA CLAY		75X8001041	75X8101041	75X8201041
ARGENTO OPACO MATT SILVER		75X8002041	75X8102041	75X8202041
BIANCO INTONACO/WHITE		75X8003041	75X8103041	75X8203041
NERO CARAVAGGIO/BLACK		75X8004041	75X8104041	75X8204041
MOKA MOCHA		75X8005041	75X8105041	75X8205041
ORO CALIFORNIA/GOLD		75X8009041	75X8109041	75X8209041
ARAMEN COPPER	OPALE/OPAL	75X8010041	75X8110041	75X8210041
GRIGIO AVIO/GREY AVIO	OPALE/OPAL	75X8011041	75X8111041	75X8211041
ARGENTO COMETA/SILVER COMET		75X8012041	75X8112041	75X8211041
OTTONE VENEZIANO/BRASS		75X8013041	75X8113041	75X8213041
TITANIO/TITANIUM		75X8014041	75X8114041	75X8214041
BRONZO RIACI/RIACI BRONZE		75X8015041	75X8115041	75X8215041
VERDE COSTA/GREEN COAST		75X8016041	75X8116041	75X8216041
TERRA SENESE SENESE EARTH		75X8017041	75X8117041	75X8217041
CROMO/CHROME		75X8008041	75X8108041	75X8208041

N.B./P.N.:

LUNGHEZZA MASSIMA VERSIONE CROMO = 2,00 m / MAXIMUM LENGTH CHROME VERSION = 2.00 m

TESTATE NON INCLUSE / DEAD ENDS NOT INCLUDED

IL DISSIPATORE INTERNO VIENE FORNITO DI SERIE IN FINITURA ALLUMINIO NATURALE / THE EXTERNAL HEATSINK IS SUPPLIED AS STANDARD IN A NATURAL ALUMINIUM FINISH

zero75

led non intergrato

not integrated led

zero75

accessori

accessories

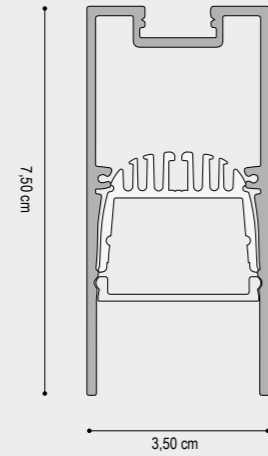

DIFFUSORE DIFFUSER	1 cm				200 cm				300 cm				400 cm			
	CODICE CODE		CODICE CODE		CODICE CODE		CODICE CODE		CODICE CODE		CODICE CODE		CODICE CODE			
OPALE/OPAL	1100100001		1100100200		1100100300		1100100400		1100100300		1100100400		1100100400			
SATINATA/SATIN	1100101001		1100101200		1100101300		1100101400		1100101300		1100101400		1100101400			
PRISMATIZZATO PRISMATIC	1100103001		1100103200		1100103300		1100103400		1100103300		1100103400		1100103400			
ECLISSI ECLIPSE	1100106001		1100106200		1100106300		1100106400		1100106300		1100106400		1100106400			

FINITURA STRUTTURA
FINISHES

- GRIGIO VESUVIO ANTHRACITE
- ARGILLA CLAY
- BIANCO INTONACO/WHITE
- NERO CARAVAGGIO BLACK
- MOKA MOCHA
- CROMO/CHROME
- ORO CALIFORNIA/GOLD
- ARAMEN COPPER
- GRIGIO AVIO GREY AVIO
- ARGENTO COMETA/SILVER COMET
- OTTONE VENEZIANO BRASS
- TITANIO/TITANIUM
- BRONZO RIACI/RIACI BRONZE
- VERDE COSTA/GREEN COAST
- TERRA SENESE SENESE EARTH

DIFFUSORE
DIFFUSER

OPALE/OPAL

1 cm	200 cm	300 cm
CODICE CODE	CODICE CODE	CODICE CODE
7503000001	7503000200	7503000300
7503010001	7503010200	7503010300
7503030001	7503030200	7503030300
7503040001	7503040200	7503040300
7503050001	7503050200	7503050300
7503080001	7503080200	7503080300
7503090001	7503090200	7503090300
7503100001	7503100200	7503100300
7503110001	7503110200	7503110300
7503120001	7503120200	7503120300
7503130001	7503130200	7503130300
7503140001	7503140200	7503140300
7503150001	7503150200	7503150300
7503160001	7503160200	7503160300
7503170001	7503170200	7503170300

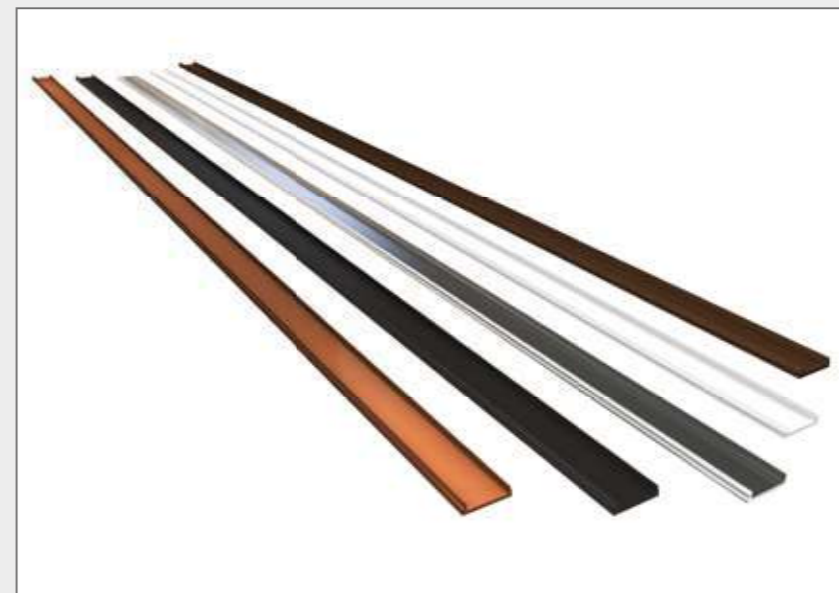

COVER ALLUMINIO / ALUMINUM COVER

1 cm		1 cm	
FINITURA STRUTTURA FINISHES	CODICE CODE	FINITURA STRUTTURA FINISHES	CODICE CODE
GRIGIO VESUVIO ANTHRACITE	1100500001	ARAMEN COPPER	1100510001
ARGILLA CLAY	1100501001	GRIGIO AVIO GREY AVIO	1100511001
ARGENTO OPACO/MATT SILVER	1100502001	ARGENTO COMETA/SILVER COMET	1100512001
BIANCO INTONACO/WHITE	1100503001	OTTONE VENEZIANO BRASS	1100513001
NERO CARAVAGGIO BLACK	1100504001	TITANIO/TITANIUM	1100514001
MOKA MOCHA	1100505001	BRONZO RIACI/RIACI BRONZE	1100515001
CROMO/CHROME	1100508001	VERDE COSTA/GREEN COAST	1100516001
ORO CALIFORNIA/GOLD	1100509001	TERRA SENESE SENESE EARTH	1100517001

N.B./P.N.:
LUNGHEZZA MASSIMA VERSIONE CROMO = 2,00 m / MAXIMUM LENGTH CHROME VERSION = 2.00 m
TESTATE NON INCLUDE / DEAD ENDS NOT INCLUDED

TESTATE DI CHIUSURA / DEAD ENDS

FINITURA STRUTTURA FINISHES	CODICE CODE	FINITURA STRUTTURA FINISHES	CODICE CODE
GRIGIO VESUVIO ANTHRACITE	750400	ARAMEN COPPER	7504100
ARGILLA CLAY	750401	GRIGIO AVIO GREY AVIO	7504110
ARGENTO OPACO MATT SILVER	750402	ARGENTO COMETA/SILVER COMET	7504120
BIANCO INTONACO/WHITE	750403	OTTONE VENEZIANO BRASS	7504130
NERO CARAVAGGIO BLACK	750404	TITANIO/TITANIUM	7504140
MOKA MOCHA	750405	BRONZO RIACI/RIACI BRONZE	7504150
CROMO CHROME	750408	VERDE COSTA/GREEN COAST	7504160
ORO CALIFORNIA/GOLD	750409	TERRA SENESE SENESE EARTH	7504170

Il codice contiene 1 testata di chiusura con viti.
The code contains 1 closing warhead with screws.

KIT DI SOSPENSIONE / SUSPENSION KIT

ARTICOLI INCLUSI NEL CODICE
ARTICLES INCLUDED IN THE CODE

Cavo in acciaio 2,00m con puntalino
2.00m steel cable with tip
Boccola cromata con regolazione millimetrica
Chrome bush with millimeter adjustment

Cavo in acciaio 3,00m con puntalino
3.00m steel cable with tip

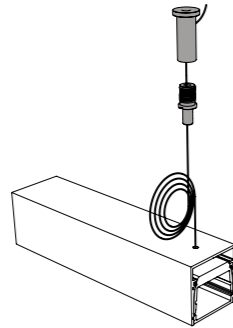

FINITURA
FINISHES

CODICE
CODE

CROMO CHROME

1100508200

1100508F30

STAFFA DI FISSAGGIO A CARTONGESSO / MOUNTING CLIP FOR PLASTERBOARD

Accessorio che consente l'incasso del modello.
Accessory that allows the collection of the model.

Nel codice sono comprese le viti per il fissaggio
del modello alla staffa. The code includes screws
for fixing their model to the bracket.

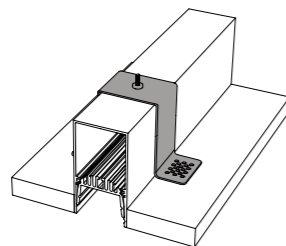

FINITURA
FINISHES

CODICE
CODE

ALLUMINIO NATURALE/ALUMINUM

750502

GIUNTI / JOINTS

GIUNTO LINEA CONTINUA / STRAIGHT JOINT

Accessorio per giunzioni meccaniche lineari
Accessory for linear mechanical joints

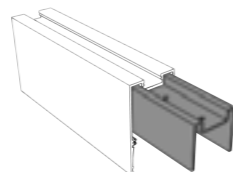

FINITURA
FINISHES

CODICE
CODE

ALLUMINIO NATURALE/ALUMINUM

75050601

GIUNTO 90° ORIZZONTALE / HORIZONTAL JOINT 90°

Accessorio per giunzioni meccaniche con angolo 90°
Accessory for linear mechanical joints with 90° angle

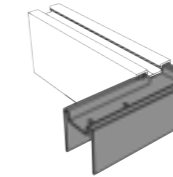

ALLUMINIO NATURALE/ALUMINUM

75050602

GIUNTO ANGOLARE A T / ANGULAR T-JOINT

Accessorio per giunzioni meccaniche a T
Accessory for mechanical T-junctions

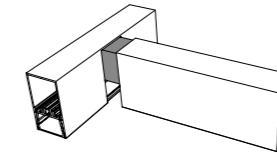

ALLUMINIO NATURALE/ALUMINUM

75050603

GIUNTO ANGOLARE A X / ANGULAR X-JOINT

Accessorio per giunzioni meccaniche a X
Accessory for mechanical X-junctions

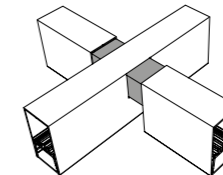

ALLUMINIO NATURALE/ALUMINUM

75050604

LAVORAZIONI / PROCESSING

DATI TECNICI
TECHNICAL DATA

CODICE
CODE

TAGLIO 90° ORIZZONTALE (PER ANGOLI FORMATI DA DUE PROFILI)
HORIZONTAL 90° CUT (FOR CORNERS MADE OF TWO PROFILES)

190X



TAGLIO 90° VERTICALE (PER ANGOLI FORMATI DA DUE PROFILI)
VERTICAL 90° CUT (FOR CORNERS MADE OF TWO PROFILES)

190Y

TAGLIO ANGOLARE CUSTOM (PER ANGOLI FORMATI DA DUE
PROFILI) CUSTOM CORNER CUT (FOR CORNERS MADE OF TWO
PROFILES)

190N



ASOLA CUSTOMIZZATA / CUSTOM SLOT

100N

FORO / HOLE

100F



CABLAGGIO - COLLAUDO - CE LED AL CENTIMETRO
INSTALLATION AND TESTING LED MODULE AT CENTIMETER

1101



CONNETTORE MASCHIO/FEMMINA
MALE/FEMALE CONNECTOR

98CFM

CONNETTORE MASCHIO/FEMMINA MONTATO NEL PRODOTTO MALE/
FEMALE CONNECTOR FITTED IN THE PRODUCT

98MFM



CAVO DI ALIMENTAZIONE 2X0,75 TONDO TRASPARENTE 1CM POWER
CABLE 2X0,75 ROUND TRANSPARENT 1CM

98CTT001



DRIVER INTEGRATO ON/OFF 60W / MOUNTING WIRING TESTING CE
MARKING DRIVER 60W

1050A

DRIVER INTEGRATO ON/OFF 96W / MOUNTING WIRING TESTING CE
MARKING DRIVER 96W

1096A



DRIVER INTEGRATO DIM 60W / MOUNTING WIRING TESTING CE
MARKING DIM DRIVER 60W

1060D

DRIVER INTEGRATO DIM 100W / MOUNTING WIRING TESTING CE
MARKING DRIVER DIM 100W

1101D

DRIVER INTEGRATO DIM 150W / MOUNTING WIRING TESTING CE
MARKING DRIVER DIM 150W

1150D

**“tecnologia al top
per qualità, resa cromatica,
lumen emessi, temperatura colore”**

ZER035 costruito in estruso di alluminio si avvale della tecnologia degli schermi in policarbonato per diffondere la luce per mezzo di LED al top, per qualità, resa cromatica, lumen emessi, ed accurata selezione della temperatura colore, scelta in base al progetto scenografico che vogliamo ottenere. ZER035 offre una gamma di finiture e di accessori, i tagli lineari e a 45° o su MISURA, rendono realizzabile qualsiasi progetto sia esso da incasso a parete, plafone o sospensione.

ZER035 is made in extruded aluminium. Use polycarbonate technology for diffusing led light with high precision, use high quality like led, colour rendering, lumen output and accurate colour temperature for ensuring optimal results for each type of project. ZER035 offers a wide gamma of finishing's and accessories, several lengths, 45°cuts or completely customized. With Zer035 it's possible to realize any kind of projects like wall-recessed, surface mounting or pendant



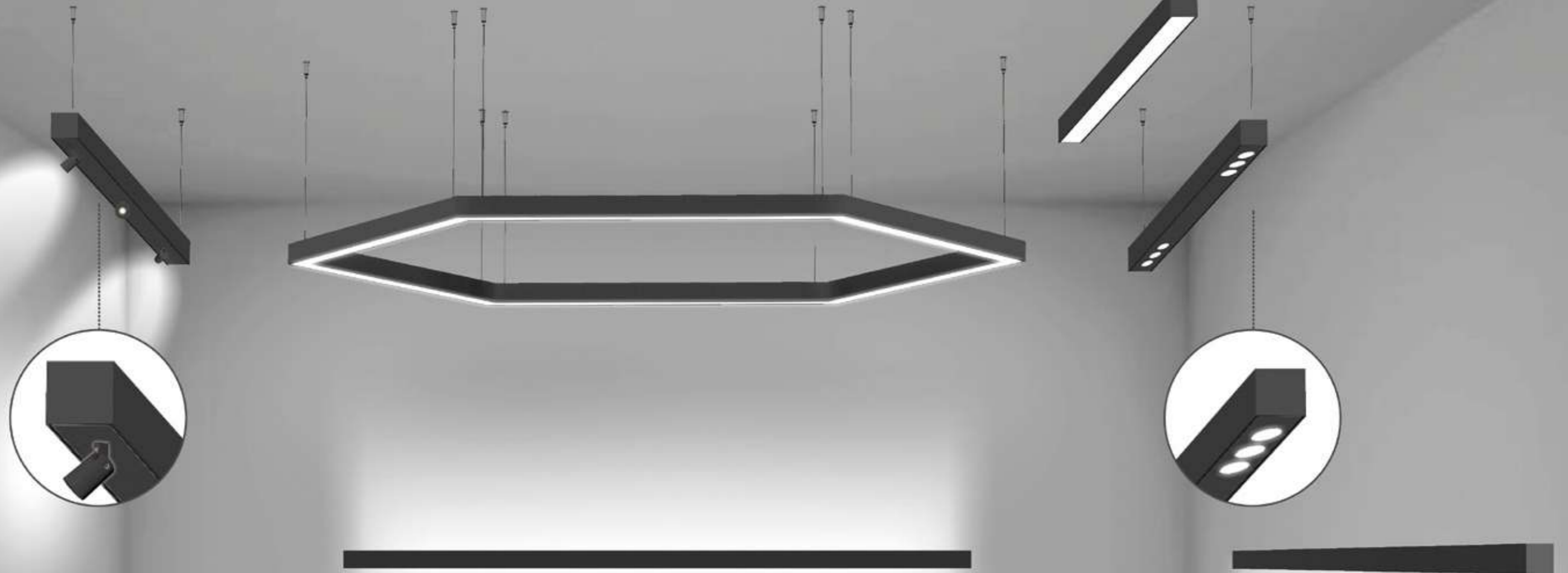

LE COMPOSIZIONI SOPRA RIPORTATE POSSONO ESSERE REALIZZATE PER INSTALLAZIONE A SOSPENSIONE / SOFFITTO-PARETE / INCASSO. PER LE COMPOSIZIONI POLIGONALI RIVOLGERSI AL NOSTRO REPARTO TECNICO.

THE ABOVE COMPOSITIONS CAN BE MADE FOR SUSPENSION / CEILING-WALL / RECESSED INSTALLATION. FOR POLYGONAL COMPOSITIONS, PLEASE CONTACT OUR TECHNICAL DEPARTMENT.

IL FISSAGGIO A SUPERFICIE NON PREVEDE UTILIZZO DI ACCESSORI. IL PRODOTTO ZERO35 SI INSTALLA A SUPERFICIE MEDIANTE UTILIZZO DI TASSELLI IDONEI AL TIPO DI MURATURA E FORANDO IL PROFILO ESTERNO IN ALLUMINIO. LA FORATURA DEL PROFILO PUÒ ESSERE RICHIESTA UTILIZZANDO IL CODICE 100F.

SURFACE MOUNTING DOES NOT INCLUDE THE USE OF ACCESSORIES. THE ZERO35 PRODUCT IS INSTALLED ON THE SURFACE BY USING DOWELS SUITABLE FOR THE TYPE OF MASONRY AND DRILLING THE EXTERNAL ALUMINUM PROFILE. PROFILE DRILLING CAN BE REQUIRED USING CODE 100F.



A. COMPOSIZIONE ANGOLARE A "L"
A. L-ANGLE COMPOSITION

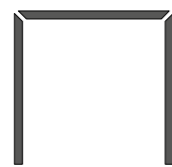

B. COMPOSIZIONE ANGOLARE A "C"
B. C-ANGLE COMPOSITION

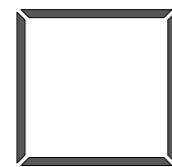

C. COMPOSIZIONE POLIGONALE (QUADRATO/RETTANGOLO)
C. POLYGONAL COMPOSITION (SQUARE / RECTANGLE)



D. COMPOSIZIONE POLIGONALE (PENTAGONO/ESAGONO)
D. POLYGONAL COMPOSITION (PENTAGON / HEX)

INSTALLAZIONE A SOSPENSIONE
SUSPENSION

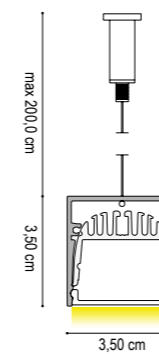

INSTALLAZIONE A SOFFITTO
CEILING INSTALLATION

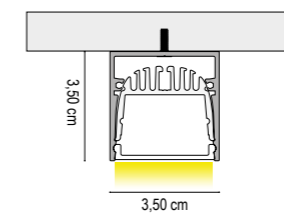

INSTALLAZIONE A INCASSO IN CARTONGESSO
RECESSED INSTALLATION IN PLASTERBOARD

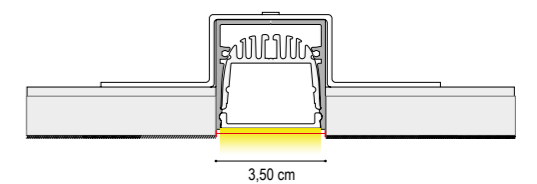

INSTALLAZIONE AD INCASSO
LARGHEZZA TAGLIO
L=3,50 cm
RECESSED INSTALLATION

ATTENZIONE! GLI ACCESSORI PER L'INSTALLAZIONE A INCASSO SONO STATI DIMENSIONATI PER UN PANNELLO STANDARD IN CARTONGESSO DI SPESSORE 12,5 mm
WARNING! THE BUILT-IN INSTALLATION ACCESSORIES HAVE BEEN DIMENSIONED FOR A STANDARD PLASTERBOARD PANEL OF 12.5 mm THICKNESS

DATI TECNICI
TECHNICAL DATA

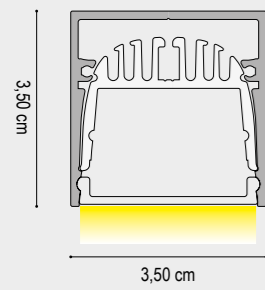

	1 cm	200 cm	300 cm
Nominal LED Flux:	2200 lm/m	4400 lm	6600 lm
Flux Tot:	1760 lm/m	3520 lm	5280 lm
Output:	110 lm/W	110 lm/W	110 lm/W
CCT:	3000 K	3000 K	3000 K
CRI:	>95	>95	>95
Power Tot:	20.0 W/m	40.0 W	60.0 W
Weight:	0.90 Kg/m	1.80 Kg	2.70 Kg

Alluminio/aluminium Cover: Opale/opal

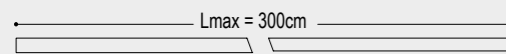

DRIVER NON INCLUSO / NOT INCLUDED

CAVO ALIMENTAZIONE : 50 cm
ALIMENTATION CABLE : 50 cm

	1 cm	200 cm	300 cm
FINITURA STRUTTURA FINISHES			
GRIGIO VESUVIO ANTHRACITE			
ARGILLA CLAY			
ARGENTO OPACO/MATT SILVER			
BIANCO INTONACO/WHITE			
NERO CARAVAGGIO BLACK			
MOKA MOCHA			
ORO CALIFORNIA/GOLD			
ARAMEN COPPER			
GRIGIO AVIO/GREY AVIO			
ARGENTO COMETA/SILVER COMET			
OTTONE VENEZIANO BRASS			
TITANIO/TITANIUM			
BRONZO RIACI/RIACI BRONZE			
VERDE COSTA/GREEN COAST			
TERRA SENESE SENESE EARTH			
CROMO/CHROME			
DIFFUSORE DIFFUSER			
OPALE/OPAL			
CODICE CODE			
1102600001	1102600200	1102600300	
1102601001	1102601200	1102601300	
1102602001	1102602200	1102602300	
1102603001	1102603200	1102603300	
1102604001	1102604200	1102604300	
1102605001	1102605200	1102605300	
1102609001	1102609200	1102609300	
1102610001	1102610200	1102610300	
1102611001	1102611200	1102611300	
1102612001	1102612200	1102612300	
1102613001	1102613200	1102613300	
1102614001	1102614200	1102614300	
1102615001	1102615200	1102615300	
1102616001	1102616200	1102616300	
1102617001	1102617200	1102617300	
1102608001	1102608200		

N.B./P.N.:
LUNGHEZZA MASSIMA VERSIONE CROMO = 2,00 m / MAXIMUM LENGTH CHROME VERSION = 2.00 m
TESTATE NON INCLUSE / DEAD ENDS NOT INCLUDED

PER LA TEMPERATURA COLORE 27K E 4K RIVOLGERSI AL NOSTRO UFFICIO TECNICO.
FOR 27K AND 4K COLOUR TEMPERATURE PLEASE CONTACT OUR TECHNICAL OFFICE.

DATI TECNICI
TECHNICAL DATA

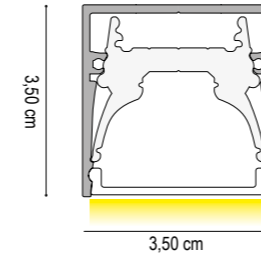

	1 cm	200 cm	300 cm
Nominal LED Flux:	2200 lm/m	4400 lm	6600 lm
Flux Tot:	1980 lm/m	3960 lm	5940 lm
Output:	110 lm/W	110 lm/W	110 lm/W
CCT:	3000 K	3000 K	3000 K
CRI:	>90	>90	>90
Power Tot:	20.0 W/m	40.0 W	60.0 W
Weight:	0.90 Kg/m	1.80 Kg	2.70 Kg

Alluminio/aluminium Cover: Prismaticato/prismatic

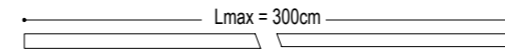

DRIVER NON INCLUSO / NOT INCLUDED

CAVO ALIMENTAZIONE : 50 cm
ALIMENTATION CABLE : 50 cm

	1 cm	200 cm	300 cm
FINITURA STRUTTURA FINISHES			
GRIGIO VESUVIO ANTHRACITE			
ARGILLA CLAY			
ARGENTO OPACO/MATT SILVER			
BIANCO INTONACO/WHITE			
NERO CARAVAGGIO BLACK			
MOKA MOCHA			
ORO CALIFORNIA/GOLD			
ARAMEN COPPER			
GRIGIO AVIO/GREY AVIO			
ARGENTO COMETA/SILVER COMET			
OTTONE VENEZIANO BRASS			
TITANIO/TITANIUM			
BRONZO RIACI/RIACI BRONZE			
VERDE COSTA/GREEN COAST			
TERRA SENESE SENESE EARTH			
CROMO/CHROME			
DIFFUSORE DIFFUSER			
PRISMATIZZATO PRISMATIC			
CODICE CODE			
1102600031	1102600230	1102600330	
1102601031	1102601230	1102601330	
1102602031	1102602230	1102602330	
1102603031	1102603230	1102603330	
1102604031	1102604230	1102604330	
1102605031	1102605230	1102605330	
1102609031	1102609230	1102609330	
1102610031	1102610230	1102610330	
1102611031	1102611230	1102611330	
1102612031	1102612230	1102612330	
1102613031	1102613230	1102613330	
1102614031	1102614230	1102614330	
1102615031	1102615230	1102615330	
1102616031	1102616230	1102616330	
1102617031	1102617230	1102617330	
1102608031	1102608230		

N.B./P.N.:
LUNGHEZZA MASSIMA VERSIONE CROMO = 2,00 m / MAXIMUM LENGTH CHROME VERSION = 2.00 m
TESTATE NON INCLUSE / DEAD ENDS NOT INCLUDED

PER LA TEMPERATURA COLORE 27K E 4K RIVOLGERSI AL NOSTRO UFFICIO TECNICO.
FOR 27K AND 4K COLOUR TEMPERATURE PLEASE CONTACT OUR TECHNICAL OFFICE.

zero35

led integrato

integrated led

DATI TECNICI
TECHNICAL DATA

	1 cm	200 cm	300 cm
Nominal LED Flux:	4050 lm/m	8100 lm	12150 lm
Flux Tot:	3510 lm/m	7020 lm	10530 lm
Output:	135 lm/W	135 lm/W	135 lm/W
CCT:	3000 K	3000 K	3000 K
CRI:	>90	>90	>90
Power Tot:	30.0 W/m	60.0 W	90.0 W
Weight:	0.90 Kg/m	1.80 Kg	2.70 Kg

3,50 cm Alluminio/aluminium Cover: Opale/opal

Lmax = 300cm DRIVER NON INCLUSO / NOT INCLUDED CAVO ALIMENTAZIONE : 50 cm
ALIMENTATION CABLE : 50 cm

	1 cm	200 cm	300 cm
FINITURA STRUTTURA FINISHES	CODICE CODE	CODICE CODE	CODICE CODE
GRIGIO VESUVIO ANTHRACITE	110810001	110810020	110810030
ARGILLA CLAY	110810101	110810120	110810130
ARGENTO OPACO/MATT SILVER	110810201	110810220	110810230
BIANCO INTONACO/WHITE	110810301	110810320	110810330
NERO CARAVAGGIO BLACK	110810401	110810420	110810430
MOKA MOCHA	110810501	110810520	110810530
ORO CALIFORNIA/GOLD	110810901	110810920	110810930
ARAMEN COPPER	110811001	110811020	110811030
GRIGIO AVIO/GREY AVIO	110811101	110811120	110811130
ARGENTO COMETA/SILVER COMET	110811201	110811220	110811230
OTTONE VENEZIANO BRASS	110811301	110811320	110811330
TITANIO/TITANIUM	110811401	110811420	110811430
BRONZO RIACI/RIACI BRONZE	110811501	110811520	110811530
VERDE COSTA/GREEN COAST	110811601	110811620	110811630
TERRA SENESE SENESE EARTH	110811701	110811720	110811730
CROMO/CHROME	110810801	110810820	

DIFFUSORE
DIFFUSER OPALE/OPAL

N.B./P.N.:
LUNGHEZZA MASSIMA VERSIONE CROMO = 2,00 m / MAXIMUM LENGTH CHROME VERSION = 2.00 m
TESTATE NON INCLUSE / DEAD ENDS NOT INCLUDED

PER LA TEMPERATURA COLORE 27K E 4K RIVOLGERSI AL NOSTRO UFFICIO TECNICO.
FOR 27K AND 4K COLOUR TEMPERATURE PLEASE CONTACT OUR TECHNICAL OFFICE.

zero35

led integrato

integrated led

DATI TECNICI
TECHNICAL DATA

	1 cm - 2700K	1 cm - 3000K	1 cm - 4000K
Nominal LED Flux:	3900 lm/m	4050 lm/m	4200 lm/m
Flux Tot:	3375 lm/m	3510 lm/m	3645 lm/m
Output:	130 lm/W	135 lm/W	140 lm/W
CCT:	2700 K	3000 K	4000 K
CRI:	>90	>90	>90
Power Tot:	30.0 W/m	30.0 W/m	30.0 W/m
Weight:	0.90 Kg/m	0.90 Kg/m	0.90 Kg/m

3,50 cm Alluminio/aluminium Cover: Prismatico/prismatic

Lmax = 300cm DRIVER NON INCLUSO / NOT INCLUDED CAVO ALIMENTAZIONE : 50 cm
ALIMENTATION CABLE : 50 cm

	1 cm	200 cm	300 cm
FINITURA STRUTTURA FINISHES	CODICE CODE	CODICE CODE	CODICE CODE
GRIGIO VESUVIO ANTHRACITE	1108100031	1108100230	1108100330
ARGILLA CLAY	1108101031	1108101230	1108101330
ARGENTO OPACO/MATT SILVER	1108102031	1108102230	1108102330
BIANCO INTONACO/WHITE	1108103031	1108103230	1108103330
NERO CARAVAGGIO BLACK	1108104031	1108104230	1108104330
MOKA MOCHA	1108105031	1108105230	1108105330
ORO CALIFORNIA/GOLD	1108109031	1108109230	1108109330
ARAMEN COPPER	1108110031	1108110230	1108110330
GRIGIO AVIO/GREY AVIO	1108111031	1108111230	1108111330
ARGENTO COMETA/SILVER COMET	1108112031	1108112230	1108112330
OTTONE VENEZIANO BRASS	1108113031	1108113230	1108113330
TITANIO/TITANIUM	1108114031	1108114230	1108114330
BRONZO RIACI/RIACI BRONZE	1108115031	1108115230	1108115330
VERDE COSTA/GREEN COAST	1108116031	1108116230	1108116330
TERRA SENESE SENESE EARTH	1108117031	1108117230	1108117330
CROMO/CHROME	1108108031	1108108230	

DIFFUSORE
DIFFUSER PRISMATIZZATO
PRISMATIC

N.B./P.N.:
LUNGHEZZA MASSIMA VERSIONE CROMO = 2,00 m / MAXIMUM LENGTH CHROME VERSION = 2.00 m
TESTATE NON INCLUSE / DEAD ENDS NOT INCLUDED





DATI TECNICI
TECHNICAL DATA

	1 cm	1 cm	1 cm
Nominal LED Flux:	2880 lm/m	3000 lm/m	3120 lm/m
Flux Tot:	2380 lm/m	2460 lm/m	2560 lm/m
Output:	120 lm/W	125 lm/W	130 lm/W
CCT:	2700 K	3000 K	4000 K
CRI:	>95	>95	>95
Power Tot:	24.0 W/m	24.0 W/m	24.0 W/m
Weight:	0.90 Kg/m	0.90 Kg/m	0.90 Kg/m

Alluminio/aluminium
Cover: Opale/opal

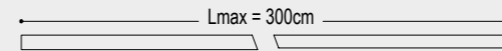
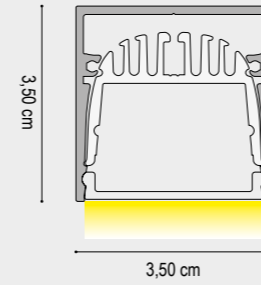

DRIVER NON INCLUSO / NOT INCLUDED

CAVO ALIMENTAZIONE : 50 cm
ALIMENTATION CABLE : 50 cm

FINITURA STRUTTURA
FINISHES

- GRIGIO VESUVIO ANTHRACITE
- ARGILLA CLAY
- ARGENTO OPACO/MATT SILVER
- BIANCO INTONACO/WHITE
- NERO CARAVAGGIO/BLACK
- MOKA MOCHA
- CROMO CHROME
- ORO CALIFORNIA/GOLD
- ARAMEN COPPER
- GRIGIO AVIO/GREY AVIO
- ARGENTO COMETA/SILVER COMET
- OTTONE VENEZIANO/BRASS
- TITANIO/TITANIUM
- BRONZO RIACI/RIACI BRONZE
- VERDE COSTA/GREEN COAST
- TERRA SENESE/SENESE EARTH

DIFFUSORE
DIFFUSER

OPALE/OPAL

	1 cm - 2700K	1 cm - 3000K	1 cm - 4000K
CODICE CODE	CODICE CODE	CODICE CODE	CODICE CODE
110H600001	110H700001	110H800001	
110H601001	110H701001	110H801001	
110H602001	110H702001	110H802001	
110H603001	110H703001	110H803001	
110H604001	110H704001	110H804001	
110H605001	110H705001	110H805001	
110H608001	110H708001	110H808001	
110H609001	110H709001	110H809001	
110H610001	110H710001	110H810001	
110H611001	110H711001	110H811001	
110H612001	110H712001	110H812001	
110H613001	110H713001	110H813001	
110H614001	110H714001	110H814001	
110H615001	110H715001	110H815001	
110H616001	110H716001	110H816001	
110H617001	110H717001	110H817001	

N.B./P.N.:

LUNGHEZZA MASSIMA VERSIONE CROMO = 2,00 m / MAXIMUM LENGTH CHROME VERSION = 2.00 m
TESTATE NON INCLUSE / DEAD ENDS NOT INCLUDED

zero35 square

led integrato

integrated led

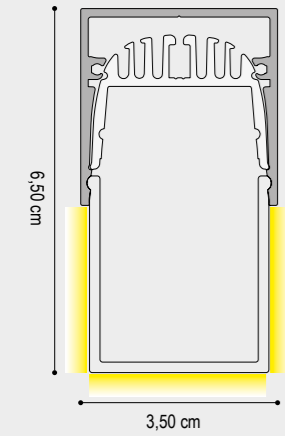

DATI TECNICI
TECHNICAL DATA

	1 cm	200 cm	300 cm
Nominal LED Flux:	3000 lm/m	6000 lm	9000 lm
Flux Tot:	2460 lm/m	4920 lm	7380 lm
Output:	140 lm/W	140 lm/W	140 lm/W
CCT:	2700 K	3000 K	4000 K
CRI:	>95	>95	>95
Power Tot:	24.0 W/m	24.0 W	24.0 W
Weight:	0.90 Kg/m	1.80 Kg	2.70 Kg

Alluminio/aluminium

Cover: Opale/opal

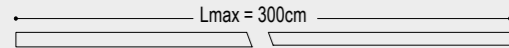

DRIVER NON INCLUSO / NOT INCLUDED

CAVO ALIMENTAZIONE : 50 cm
ALIMENTATION CABLE : 50 cm

zero35 square

led integrato

integrated led

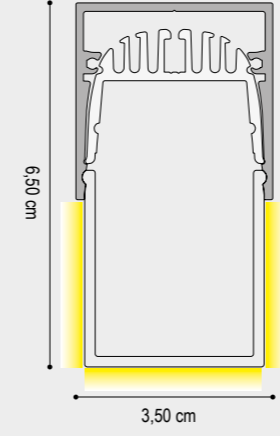

DATI TECNICI
TECHNICAL DATA

	1 cm	200 cm	300 cm
Nominal LED Flux:	4050 lm/m	8100 lm	12150 lm
Flux Tot:	3250 lm/m	6480 lm	9720 lm
Output:	135 lm/W	135 lm/W	135 lm/W
CCT:	3000 K	3000 K	3000 K
CRI:	>90	>90	>90
Power Tot:	30.0 W/m	60.0 W	90.0 W
Weight:	0.90 Kg/m	1.80 Kg	2.70 Kg

Alluminio/aluminium

Cover: Opale/opal

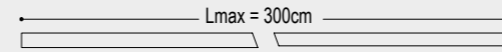

DRIVER NON INCLUSO / NOT INCLUDED

CAVO ALIMENTAZIONE : 50 cm
ALIMENTATION CABLE : 50 cm

FINITURA STRUTTURA
FINISHES

- GRIGIO VESUVIO ANTHRACITE
- ARGILLA CLAY
- ARGENTO OPACO/MATT SILVER
- BIANCO INTONACO/WHITE
- NERO CARAVAGGIO/BLACK
- MOKA MOCHA
- CROMO/CHROME
- ORO CALIFORNIA/GOLD
- ARAMEN COPPER
- GRIGIO AVIO/ GREY AVIO
- ARGENTO COMETA/SILVER COMET
- OTTONE VENEZIANO/BRASS
- TITANIO/TITANIUM
- BRONZO RIACI/RIACI BRONZE
- VERDE COSTA/GREEN COAST
- TERRA SENESE SENESE EARTH

DIFFUSORE
DIFFUSER

OPALE/OPAL

1 cm - 2700K

CODICE CODE
110H600701
110H601701
110H602701
110H603701
110H604701
110H605701
110H608701
110H609701
110H610701
110H611701
110H612701
110H613701
110H614701
110H615701
110H616701
110H617701

1 cm - 3000K

CODICE CODE
110H700701
110H701701
110H702701
110H703701
110H704701
110H705701
110H708701
110H709701
110H710701
110H711701
110H712701
110H713701
110H714701
110H715701
110H716701
110H717701

1 cm - 4000K

CODICE CODE
110H800701
110H801701
110H802701
110H803701
110H804701
110H805701
110H808701
110H809701
110H810701
110H811701
110H812701
110H813701
110H814701
110H815701
110H816701
110H817701

N.B./P.N.:
LUNGHEZZA MASSIMA VERSIONE CROMO = 2,00 m / MAXIMUM LENGTH CHROME VERSION = 2.00 m
TESTATE NON INCLUSE / DEAD ENDS NOT INCLUDED

FINITURA STRUTTURA
FINISHES

- GRIGIO VESUVIO ANTHRACITE
- ARGILLA CLAY
- ARGENTO OPACO/MATT SILVER
- BIANCO INTONACO/WHITE
- NERO CARAVAGGIO/BLACK
- MOKA MOCHA
- ORO CALIFORNIA/GOLD
- ARAMEN COPPER
- GRIGIO AVIO/ GREY AVIO
- ARGENTO COMETA/SILVER COMET
- OTTONE VENEZIANO/BRASS
- TITANIO/TITANIUM
- BRONZO RIACI/RIACI BRONZE
- VERDE COSTA/GREEN COAST
- TERRA SENESE SENESE EARTH
- CROMO/CHROME

DIFFUSORE
DIFFUSER

OPALE/OPAL

1 cm

CODICE CODE
1108100701
1108101701
1108102701
1108103701
1108104701
1108105701
1108109701
1108110701
1108111701
1108112701
1108113701
1108114701
1108115701
1108116701
1108117701
1108108701

200 cm

CODICE CODE
1108100720
1108101720
1108102720
1108103720
1108104720
1108105720
1108109720
1108110720
1108111720
1108112720
1108113720
1108114720
1108115720
1108116720
1108117720
1108108720

300 cm

CODICE CODE
1108100730
1108101730
1108102730
1108103730
1108104730
1108105730
1108109730
1108110730
1108111730
1108112730
1108113730
1108114730
1108115730
1108116730
1108117730

N.B./P.N.:
LUNGHEZZA MASSIMA VERSIONE CROMO = 2,00 m / MAXIMUM LENGTH CHROME VERSION = 2.00 m
TESTATE NON INCLUSE / DEAD ENDS NOT INCLUDED

PER LA TEMPERATURA COLORE 27K E 4K RIVOLGERSI AL NOSTRO UFFICIO TECNICO.
FOR 27K AND 4K COLOUR TEMPERATURE PLEASE CONTACT OUR TECHNICAL OFFICE.

TESTATE DI CHIUSURA SQUARE / SQUARE DEAD ENDS

FINITURA STRUTTURA FINISHES	CODICE CODE	FINITURA STRUTTURA FINISHES	CODICE CODE
GRIGIO VESUVIO ANTHRACITE	1100800000	ARAMEN COPPER	1100810000
ARGILLA CLAY	1100801000	GRIGIO AVIO/ GREY AVIO	1100811000
ARGENTO OPACO/MATT SILVER	1100802000	ARGENTO COMETA/SILVER COMET	1100812000
BIANCO INTONACO/WHITE	1100803000	OTTONE VENEZIANO/BRASS	1100813000
NERO CARAVAGGIO/BLACK	1100804000	TITANIO/TITANIUM	1100814000
MOKA MOCHA	1100805000	BRONZO RIACI/RIACI BRONZE	1100815000
CROMO/CHROME	1100808000	VERDE COSTA/GREEN COAST	1100816000
ORO CALIFORNIA/GOLD	1100809000	TERRA SENESE SENESE EARTH	1100817000

Il codice contiene 1 testata di chiusura con viti.
The code contains 1 closing warhead with screws.



zero35

led non intergrato

not integrated led



zero35

accessori

accessories

	1 cm	200 cm	300 cm	400 cm
DIFFUSORE DIFFUSER	CODICE CODE	CODICE CODE	CODICE CODE	CODICE CODE
OPALE/OPAL	1100100001	1100100200	1100100300	1100100400
SATINATA/SATIN	1100101001	1100101200	1100101300	1100101400
PRISMATIZZATO PRISMATIC	1100103001	1100103200	1100103300	1100103400
ECLISSI ECLIPSE	1100106001	1100106200	1100106300	1100106400

	10 mt	1 cm
DIFFUSORE DIFFUSER	CODICE CODE	DIFFUSORE DIFFUSER
OPALE/OPAL	1100100999	OPALE/OPAL
PRISMATIZZATO PRISMATIC	1100103999	1100100701

FINITURA STRUTTURA
FINISHES

- GRIGIO VESUVIO ANTHRACITE
- ARGILLA CLAY
- ARGENTO OPACO/MATT SILVER
- BIANCO INTONACO/WHITE
- NERO CARAVAGGIO BLACK
- MOKA MOCHA
- ORO CALIFORNIA/GOLD
- ARAMEN COPPER
- GRIGIO AVIO/GREY AVIO
- ARGENTO COMETA/SILVER COMET
- OTTONE VENEZIANO BRASS
- TITANIO/TITANIUM
- BRONZO RIACI/RIACI BRONZE
- VERDE COSTA/GREEN COAST
- TERRA SENESE SENESE EARTH
- CROMO/CHROME

	1 cm	200 cm	300 cm
CODICE CODE	CODICE CODE	CODICE CODE	CODICE CODE
1100300001	1100300200	1100300300	1100300300
1100301001	1100301200	1100301300	1100301300
1100302001	1100302200	1100302300	1100302300
1100303001	1100303200	1100303300	1100303300
1100304001	1100304200	1100304300	1100304300
1100305001	1100305200	1100305300	1100305300
1100309001	1100309200	1100309300	1100309300
1100310001	1100310200	1100310300	1100310300
1100311001	1100311200	1100311300	1100311300
1100312001	1100312200	1100312300	1100312300
1100313001	1100313200	1100313300	1100313300
1100314001	1100314200	1100314300	1100314300
1100315001	1100315200	1100315300	1100315300
1100316001	1100316200	1100316300	1100316300
1100317001	1100317200	1100317300	1100317300
1100308001	1100308200		

N.B./P.N.:

LUNGHEZZA MASSIMA VERSIONE CROMO = 2,00 m / MAXIMUM LENGTH CHROME VERSION = 2.00 m
TESTATE NON INCLUDE / DEAD ENDS NOT INCLUDED

LED compatibili / LED compatibility

HIGH QUALITY CRI>90 CRI>95	HIGH OUTPUT CRI>90 CRI>95	HIGH EFFICIENT CRI>90 CRI>95	HIGH INTENSITY CRI>90 CRI>95	LOW POWER CRI>90	ULTRA SLIM CRI>90 CRI>95 CRI>97	RGB	RGB WHITE	RGB TW	TUNABLE WHITE
9,6W 14,4W 19,2W	12,3W 14,4W 19,2W 20W 24W	12,3W 14,4W 19,2W 20W 24W	24W 24W (700 LED)	6W	9,6W 12W 14,4W	14W	14W	14,4W 23 W	19,2W

zero35

aluminum cover

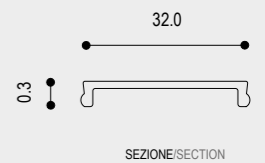
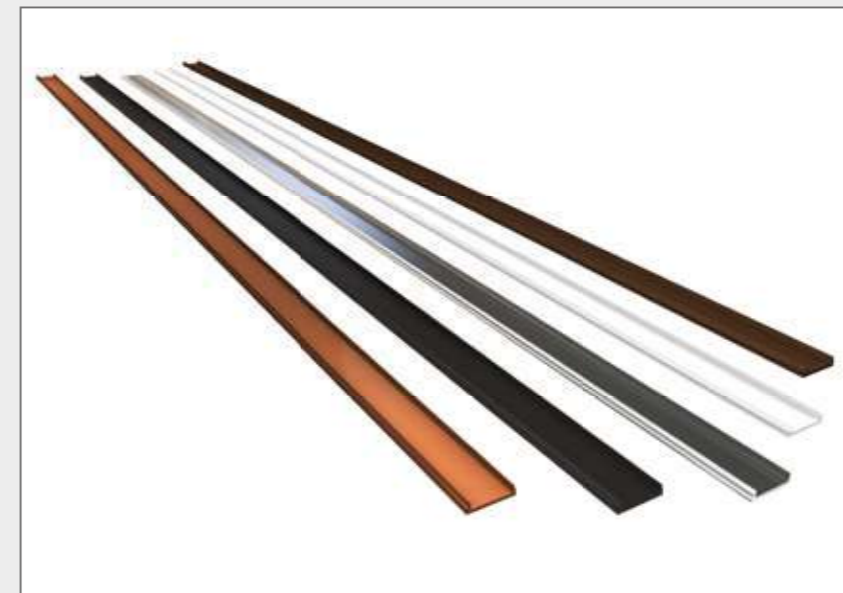

	1 cm	1 cm
FINITURA STRUTTURA FINISHES	CODICE CODE	FINITURA STRUTTURA FINISHES
GRIGIO VESUVIO ANTHRACITE	1100500001	ARAMEN COPPER
ARGILLA CLAY	1100501001	GRIGIO AVIO/GREY AVIO
ARGENTO OPACO/MATT SILVER	1100502001	ARGENTO COMETA/SILVER COMET
BIANCO INTONACO/WHITE	1100503001	OTTONE VENEZIANO BRASS
NERO CARAVAGGIO BLACK	1100504001	TITANIO/TITANIUM
MOKA MOCHA	1100505001	BRONZO RIACI/RIACI BRONZE
CROMO/CHROME	1100508001	VERDE COSTA/GREEN COAST
ORO CALIFORNIA/GOLD	1100509001	TERRA SENESE SENESE EARTH

TESTATE DI CHIUSURA / DEAD ENDS

FINITURA STRUTTURA FINISHES	CODICE CODE	FINITURA STRUTTURA FINISHES	CODICE CODE
GRIGIO VESUVIO ANTHRACITE	1100400000	ARAMEN COPPER	1100410000
ARGILLA CLAY	1100401000	GRIGIO AVIO GREY AVIO	1100411000
ARGENTO OPACO MATT SILVER	1100402000	ARGENTO COMETA SILVER COMET	1100412000
BIANCO INTONACO WHITE	1100403000	OTTONE VENEZIANO BRASS	1100413000
NERO CARAVAGGIO BLACK	1100404000	TITANIO TITANIUM	1100414000
MOKA MOCHA	1100405000	BRONZO RIACI RIACI BRONZE	1100415000
CROMO CHROME	1100408000	VERDE COSTA GREEN COAST	1100416000
ORO CALIFORNIA GOLD	1100409000	TERRA SENESE SENESE EARTH	1100417000

Il codice contiene 1 testata di chiusura con viti.
The code contains 1 closing warhead with screws.

TESTATE DI CHIUSURA CON LOGO / DEAD ENDS WITH LOGO

FINITURA STRUTTURA FINISHES	CODICE CODE	FINITURA STRUTTURA FINISHES	CODICE CODE
GRIGIO VESUVIO ANTHRACITE	1100600000	GRIGIO AVIO GREY AVIO	1100611000
ARGILLA CLAY	1100601000	ARGENTO COMETA SILVER COMET	1100612000
BIANCO INTONACO WHITE	1100603000	OTTONE VENEZIANO BRASS	1100613000
NERO CARAVAGGIO BLACK	1100604000	TITANIO TITANIUM	1100614000
MOKA MOCHA	1100605000	BRONZO RIACI RIACI BRONZE	1100615000
CROMO CHROME	1100608000	VERDE COSTA GREEN COAST	1100616000
ORO CALIFORNIA GOLD	1100609000	TERRA SENESE SENESE EARTH	1100617000
ARAMEN COPPER	1100610000		

Il codice contiene 1 testata di chiusura con viti.
The code contains 1 closing warhead with screws.

KIT DI SOSPENSIONE / SUSPENSION KIT

ARTICOLI INCLUSI NEL CODICE ARTICLES INCLUDED IN THE CODE	FINITURA FINISHES	CODICE CODE
Cavo in acciaio 2,00 m con puntalino 2.00m steel cable with tip Boccola cromata con regolazione millimetrica Chrome bush with millimeter adjustment	CROMO CHROME	1100508200
Cavo in acciaio 3,00 m con puntalino 3.00m steel cable with tip		1100508F30

STAFFA DI FISSAGGIO A CARTONGESSO / MOUNTING CLIP FOR PLASTERBOARD

Accessorio che consente l'incasso del modello. Accessory that allows the collection of the model.	FINITURA FINISHES	CODICE CODE
Nel codice sono comprese le viti per il fissaggio del modello alla staffa. The code includes screws for fixing the model to the bracket.	ALLUMINIO NATURALE ALUMINUM	1100500002

GIUNTI / JOINTS

	FINITURA FINISHES	CODICE CODE
GIUNTO LINEA CONTINUA / STRAIGHT JOINT Accessorio per giunzioni meccaniche lineari Accessory for linear mechanical joints	ALLUMINIO NATURALE ALUMINUM	1100506001
GIUNTO 90° ORIZZONTALE / HORIZONTAL JOINT 90° Accessorio per giunzioni meccaniche con angolo 90° Accessory for linear mechanical joints with 90° angle	ALLUMINIO NATURALE ALUMINUM	1100506002
GIUNTO 90° VERTICALE INTERNO / VERTICAL JOINT 90° Accessorio per giunzioni meccaniche con angolo 90° Accessory for linear mechanical joints with 90° angle	ALLUMINIO NATURALE ALUMINUM	1100506003
GIUNTO 90° VERTICALE ESTERNO / VERTICAL JOINT 90° Accessorio per giunzioni meccaniche con angolo 90° Accessory for linear mechanical joints with 90° angle	ALLUMINIO NATURALE ALUMINUM	1100506004
GIUNTO ANGOLARE A T / ANGULAR T-JOINT Accessorio per giunzioni meccaniche a T Accessory for mechanical T-junctions	ALLUMINIO NATURALE ALUMINUM	1100506006
GIUNTO ANGOLARE A X / ANGULAR T-JOINT Accessorio per giunzioni meccaniche a X Accessory for mechanical T-junctions	ALLUMINIO NATURALE ALUMINUM	1100506007

Nei codici sono compresi i grani per il fissaggio del giunto.
The code includes the grains to fix the joint.

LAVORAZIONI / PROCESSING

DATI TECNICI TECHNICAL DATA	CODICE CODE
TAGLIO 90° ORIZZONTALE (PER ANGOLI FORMATI DA DUE PROFILI) HORIZONTAL 90° CUT (FOR CORNERS MADE OF TWO PROFILES)	190X
TAGLIO 90° VERTICALE (PER ANGOLI FORMATI DA DUE PROFILI) VERTICAL 90° CUT (FOR CORNERS MADE OF TWO PROFILES)	190Y
TAGLIO ANGOLARE CUSTOM (PER ANGOLI FORMATI DA DUE PROFILI) CUSTOM CORNER CUT (FOR CORNERS MADE OF TWO PROFILES)	190N
ASOLA CUSTOMIZZATA / CUSTOM SLOT	100N
FORO / HOLE	100F
CABLAGGIO - COLLAUDO - CE LED AL CENTIMETRO INSTALLATION AND TESTING LED MODULE AT CENTIMETER	1101
CONNETTORE MASCHIO/FEMMINA MALE/FEMALE CONNECTOR	98CFM
CONNETTORE MASCHIO/FEMMINA MONTATO NEL PRODOTTO MALE/ FEMALE CONNECTOR FITTED IN THE PRODUCT	98MFM
CAVO DI ALIMENTAZIONE 2X0,75 TONDO TRASPARENTE 1CM POWER CABLE 2X0,75 ROUND TRANSPARENT 1CM	98CTT001

“sistema a led biemissione”

ZER035X costruito in estruso di alluminio si avvale della tecnologia degli schermi in policarbonato per diffondere la luce per mezzo di LED al top, per qualità, resa cromatica, lumen emessi, ed accurata selezione della temperatura colore, scelta in base al progetto scenografici +co che vogliamo ottenere. ZER035X è un sistema di illuminazione LED biemissione pensato per illuminare gli ambienti con una luce diretta sul piano e una luce diffusa. È proposto in due versioni: con ottica recessa (con valore di UGR<19 lungo l'asse trasversale) e con ottica esterna.

ZER035X built in extruded aluminum uses the technology of polycarbonate screens to diffuse the light by means of top LEDs, for quality, color rendering, lumens emitted, and careful selection of the color temperature, chosen on the basis of the scenographic project which we want to get. ZER035X is a bi-emission LED lighting system designed to illuminate environments with direct light on the surface and diffused light. It is proposed in two versions: with recessed optic (with UGR value <19 along the transverse axis) and with external optics.



zero35 x

zero35 x

configurazioni

configurations

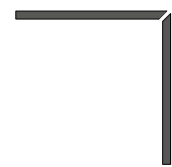

A. COMPOSIZIONE ANGOLARE A "L"
A. L-ANGLE COMPOSITION

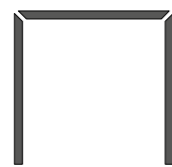

B. COMPOSIZIONE ANGOLARE A "C"
B. C-ANGLE COMPOSITION

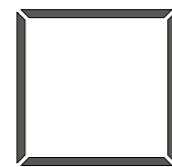

C. COMPOSIZIONE POLIGONALE (QUADRATO/RETTANGOLO)
C. POLYGONAL COMPOSITION (SQUARE / RECTANGLE)



D. COMPOSIZIONE POLIGONALE (PENTAGONO/ESAGONO)
D. POLYGONAL COMPOSITION (PENTAGON / HEX)

PER LE COMPOSIZIONI POLIGONALI RIVOLGERSI AL NOSTRO UFFICIO TECNICO.
FOR POLYGONAL COMPOSITIONS, PLEASE CONTACT OUR TECHNICAL OFFICE.

INSTALLAZIONE A SOSPENSIONE
SUSPENSION

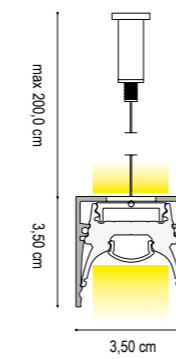

ZER035X CON DIFFUSORE RECESSO
ZER035X WITH RECESSED DIFFUSER

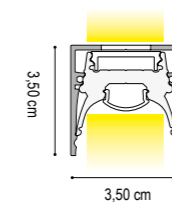

ZER035X CON DIFFUSORE ESTERNO
ZER035X WITH EXTERNAL DIFFUSER

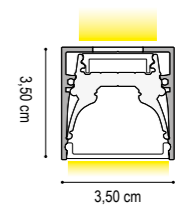

DATI TECNICI
TECHNICAL DATA

DIFFUSORE RECESSO / RECESSED DIFFUSER

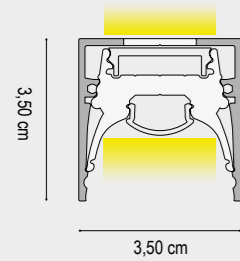

	1 cm - 40W/m	200 cm - 80W	300 cm - 120W
Nominal LED Flux:	↑ 2200 lm/m - 2200 lm/m ↓	↑ 4400 lm - 4400 lm ↓	↑ 6600 lm - 6600 lm ↓
Flux Tot:	↑ 1890 lm/m - 1680 lm/m ↓	↑ 3780 lm - 3360 lm ↓	↑ 5670 lm - 5040 lm ↓
Output:	110 lm/W	110 lm/W	110 lm/W
CCT:	3000 K	3000 K	3000 K
CRI:	>95	>95	>95
Power:	↑ 20.0W/m - 20.0W/m ↓	↑ 40.0W - 40.0W ↓	↑ 60.0W - 60.0W ↓
Power Tot:	40.0W/m	80.0W	120.0W
Weight:	1.40 Kg/m	2.80 Kg	4.20 Kg

Alluminio/aluminium

Cover: Opale/opal - Satinato/Satin

Lmax = 300cm

DRIVER NON INCLUSO / NOT INCLUDED

CAVO ALIMENTAZIONE : 50 cm
ALIMENTATION CABLE : 50 cm

1 cm

200 cm

300 cm

FINITURA STRUTTURA
FINISHES

- GRIGIO VESUVIO ANTHRACITE
- ARGILLA CLAY
- ARGENTO OPACO/MATT SILVER
- BIANCO INTONACO/WHITE
- NERO CARAVAGGIO BLACK
- MOKA MOCHA
- ORO CALIFORNIA/GOLD
- ARAMEN COPPER
- GRIGIO AVIO/GREY AVIO
- ARGENTO COMETA/SILVER COMET
- OTTONE VENEZIANO BRASS
- TITANIO/TITANIUM
- BRONZO RIACURIACI BRONZE
- VERDE COSTA/GREEN COAST
- TERRA SENESE SENESE EARTH
- CROMO/CHROME

DIFFUSORE
DIFFUSER

- SATINATA/SATIN
- OPALE/OPAL

CODICE
CODE

- 1162600001
- 1162601001
- 1162602001
- 1162603001
- 1162604001
- 1162605001
- 1162609001
- 1162610001
- 1162611001
- 1162612001
- 1162613001
- 1162614001
- 1162615001
- 1162616001
- 1162617001
- 1162608001

CODICE
CODE

- 1162600200
- 1162601200
- 1162602200
- 1162603200
- 1162604200
- 1162605200
- 1162609200
- 1162610200
- 1162611200
- 1162612200
- 1162613200
- 1162614200
- 1162615200
- 1162616200
- 1162617200
- 1162608200

CODICE
CODE

- 1162600300
- 1162601300
- 1162602300
- 1162603300
- 1162604300
- 1162605300
- 1162609300
- 1162610300
- 1162611300
- 1162612300
- 1162613300
- 1162614300
- 1162615300
- 1162616300
- 1162617300

N.B./P.N.:

LUNGHEZZA MASSIMA VERSIONE CROMO = 2,00 m / MAXIMUM LENGTH CHROME VERSION = 2.00 m

TESTATE NON INCLUSE / DEAD ENDS NOT INCLUDED

IL DISSIPATORE INTERNO VIENE FORNITO DI SERIE IN FINITURA ALLUMINIO/ THE INTERNAL HEAT SINK IS SUPPLIED AS STANDARD IN ALUMINUM FINISH

DATI TECNICI
TECHNICAL DATA

DIFFUSORE RECESSO / RECESSED DIFFUSER

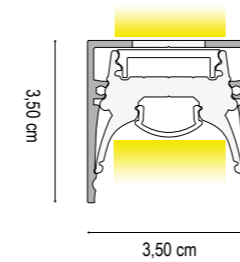

	1 cm - 40W/m	200 cm - 80W	300 cm - 120W
Nominal LED Flux:	↑ 4440 lm/m - 4440 lm/m ↓	↑ 8880 lm - 8880 lm ↓	↑ 13320 lm - 13320 lm ↓
Flux Tot:	↑ 3552 lm/m - 3552 lm/m ↓	↑ 7104 lm - 7104 lm ↓	↑ 10656 lm - 10656 lm ↓
Output:	148 lm/W	148 lm/W	148 lm/W
CCT:	3000 K	3000 K	3000 K
CRI:	>90	>90	>90
Power:	↑ 30.0W/m - 30.0W/m ↓	↑ 60.0W - 60.0W ↓	↑ 90.0W - 90.0W ↓
Power Tot:	60.0W/m	120.0W	180.0W
Weight:	1.40 Kg/m	2.80 Kg	4.20 Kg

Alluminio/aluminium

Cover: Opale/opal - Satinato/Satin

Lmax = 300cm

DRIVER NON INCLUSO / NOT INCLUDED

CAVO ALIMENTAZIONE : 50 cm
ALIMENTATION CABLE : 50 cm

1 cm

200 cm

300 cm

FINITURA STRUTTURA
FINISHES

- GRIGIO VESUVIO ANTHRACITE
- ARGILLA CLAY
- ARGENTO OPACO/MATT SILVER
- BIANCO INTONACO/WHITE
- NERO CARAVAGGIO BLACK
- MOKA MOCHA
- ORO CALIFORNIA/GOLD
- ARAMEN COPPER
- GRIGIO AVIO/GREY AVIO
- ARGENTO COMETA/SILVER COMET
- OTTONE VENEZIANO BRASS
- TITANIO/TITANIUM
- BRONZO RIACURIACI BRONZE
- VERDE COSTA/GREEN COAST
- TERRA SENESE SENESE EARTH
- CROMO/CHROME

DIFFUSORE
DIFFUSER

- SATINATA/SATIN
- OPALE/OPAL

CODICE
CODE

- 1168100001
- 1168101001
- 1168102001
- 1168103001
- 1168104001
- 1168105001
- 1168109001
- 1168110001
- 1168111001
- 1168112001
- 1168113001
- 1168114001
- 1168115001
- 1168116001
- 1168117001
- 1168108001

CODICE
CODE

- 1168100200
- 1168101200
- 1168102200
- 1168103200
- 1168104200
- 1168105200
- 1168109200
- 1168110200
- 1168111200
- 1168112200
- 1168113200
- 1168114200
- 1168115200
- 1168116200
- 1168117200
- 1168108200

CODICE
CODE

- 1168100300
- 1168101300
- 1168102300
- 1168103300
- 1168104300
- 1168105300
- 1168109300
- 1168110300
- 1168111300
- 1168112300
- 1168113300
- 1168114300
- 1168115300
- 1168116300
- 1168117300

N.B./P.N.:

LUNGHEZZA MASSIMA VERSIONE CROMO = 2,00 m / MAXIMUM LENGTH CHROME VERSION = 2.00 m

TESTATE NON INCLUSE / DEAD ENDS NOT INCLUDED

IL DISSIPATORE INTERNO VIENE FORNITO DI SERIE IN FINITURA ALLUMINIO/ THE INTERNAL HEAT SINK IS SUPPLIED AS STANDARD IN ALUMINUM FINISH

DATI TECNICI
TECHNICAL DATA

DIFFUSORE ESTERNO / EXTERNAL DIFFUSER

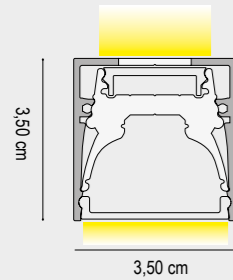

	1 cm - 40W/m	200 cm - 80W	300 cm - 120W
Nominal LED Flux:	↑ 2200 lm/m - 2200 lm/m ↓	↑ 4400 lm - 4400 lm ↓	↑ 6600 lm - 6600 lm ↓
Flux Tot:	↑ 1890 lm/m - 1680 lm/m ↓	↑ 3780 lm - 3360 lm ↓	↑ 5670 lm - 5040 lm ↓
Output:	110 lm/W	110 lm/W	110 lm/W
CCT:	3000 K	3000 K	3000 K
CRI:	>95	>95	>95
Power:	↑ 20.0W/m - 20.0W/m ↓	↑ 40.0W - 40.0W ↓	↑ 60.0W - 60.0W ↓
Power Tot:	40.0W/m	80.0W	120.0W
Weight:	1.40 Kg/m	2.80 Kg	4.20 Kg

Alluminio/aluminium

Cover: Opale/opal - Satinato/Satin

Lmax = 300cm

DRIVER NON INCLUSO / NOT INCLUDED

CAVO ALIMENTAZIONE : 50 cm
ALIMENTATION CABLE : 50 cm

1 cm 200 cm 300 cm

FINITURA STRUTTURA
FINISHES

- GRIGIO VESUVIO ANTHRACITE
- ARGILLA CLAY
- ARGENTO OPACO MATT SILVER
- BIANCO INTONACO/WHITE
- NERO CARAVAGGIO BLACK
- MOKA MOCHA
- ORO CALIFORNIA/GOLD
- ARAMEN COPPER
- GRIGIO AVIO/GREY AVIO
- ARGENTO COMETA/SILVER COMET
- OTTONE VENEZIANO/BRASS
- TITANIO/TITANIUM
- BRONZO RIACI/RIACI BRONZE
- VERDE COSTA/GREEN COAST
- TERRA SENESE SENESE EARTH
- CROMO/CHROME

DIFFUSORE
DIFFUSER

- SATINATA/SATIN
- OPALE/OPAL

CODICE CODE	CODICE CODE	CODICE CODE
116260011	1162600210	1162600310
1162601011	1162601210	1162601310
1162602011	1162602210	1162602310
1162603011	1162603210	1162603310
1162604011	1162604210	1162604310
1162605011	1162605210	1162605310
1162609011	1162609210	1162609310
1162610011	1162610210	1162610310
1162611011	1162611210	1162611310
1162612011	1162612210	1162612310
1162613011	1162613210	1162613310
1162614011	1162614210	1162614310
1162615011	1162615210	1162615310
1162616011	1162616210	1162616310
1162617011	1162617210	1162617310
1162608011	1162608210	

N.B./P.N.:
LUNGHEZZA MASSIMA VERSIONE CROMO = 2,00 m / MAXIMUM LENGTH CHROME VERSION = 2.00 m
TESTATE NON INCLUSE / DEAD ENDS NOT INCLUDED
IL DISSIPATORE INTERNO VIENE FORNITO DI SERIE IN FINITURA ALLUMINIO/ THE INTERNAL HEAT SINK IS SUPPLIED AS STANDARD IN ALUMINUM FINISH

DATI TECNICI
TECHNICAL DATA

DIFFUSORE ESTERNO / EXTERNAL DIFFUSER

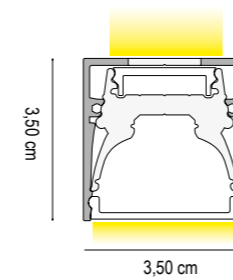

	1 cm - 40W/m	200 cm - 80W	300 cm - 120W
Nominal LED Flux:	↑ 4050 lm/m - 4050 lm/m ↓	↑ 8100 lm - 8100 lm ↓	↑ 12150 lm - 12150 lm ↓
Flux Tot:	↑ 3510 lm/m - 3510 lm/m ↓	↑ 7020 lm - 7020 lm ↓	↑ 10530 lm - 10530 lm ↓
Output:	135 lm/W	135 lm/W	135 lm/W
CCT:	3000 K	3000 K	3000 K
CRI:	>90	>90	>90
Power:	↑ 30.0W/m - 30.0W/m ↓	↑ 60.0W - 60.0W ↓	↑ 90.0W - 90.0W ↓
Power Tot:	60.0W/m	120.0W	180.0W
Weight:	1.40 Kg/m	2.80 Kg	4.20 Kg

Alluminio/aluminium

Cover: Opale/opal - Satinato/Satin

Lmax = 300cm

DRIVER NON INCLUSO / NOT INCLUDED

CAVO ALIMENTAZIONE : 50 cm
ALIMENTATION CABLE : 50 cm

1 cm 200 cm 300 cm

FINITURA STRUTTURA
FINISHES

- GRIGIO VESUVIO ANTHRACITE
- ARGILLA CLAY
- ARGENTO OPACO MATT SILVER
- BIANCO INTONACO/WHITE
- NERO CARAVAGGIO BLACK
- MOKA MOCHA
- ORO CALIFORNIA/GOLD
- ARAMEN COPPER
- GRIGIO AVIO/GREY AVIO
- ARGENTO COMETA/SILVER COMET
- OTTONE VENEZIANO/BRASS
- TITANIO/TITANIUM
- BRONZO RIACI/RIACI BRONZE
- VERDE COSTA/GREEN COAST
- TERRA SENESE SENESE EARTH
- CROMO/CHROME

DIFFUSORE
DIFFUSER

- SATINATA/SATIN
- OPALE/OPAL

CODICE CODE	CODICE CODE	CODICE CODE
1168100011	1168100210	1168100310
1168101011	1168101210	1168101310
1168102011	1168102210	1168102310
1168103011	1168103210	1168103310
1168104011	1168104210	1168104310
1168105011	1168105210	1168105310
1168109011	1168109210	1168109310
1168110011	1168110210	1168110310
1168111011	1168111210	1168111310
1168112011	1168112210	1168112310
1168113011	1168113210	1168113310
1168114011	1168114210	1168114310
1168115011	1168115210	1168115310
1168116011	1168116210	1168116310
1168117011	1168117210	1168117310
1168108011	1168108210	

N.B./P.N.:
LUNGHEZZA MASSIMA VERSIONE CROMO = 2,00 m / MAXIMUM LENGTH CHROME VERSION = 2.00 m
TESTATE NON INCLUSE / DEAD ENDS NOT INCLUDED
IL DISSIPATORE INTERNO VIENE FORNITO DI SERIE IN FINITURA ALLUMINIO/ THE INTERNAL HEAT SINK IS SUPPLIED AS STANDARD IN ALUMINUM FINISH

DATI TECNICI
TECHNICAL DATA

DIFFUSORE PRISMATIZZATO / PRISMATIC DIFFUSER

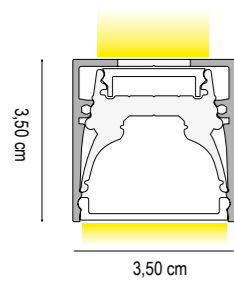

	1 cm - 40W/m	200 cm - 80W	300 cm - 120W
Nominal LED Flux:	↑ 4050 lm/m - 4050 lm/m ↓	↑ 8100 lm - 8100 lm ↓	↑ 12150 lm - 12150 lm ↓
Flux Tot:	↑ 3510 lm/m - 3645 lm/m ↓	↑ 7020 lm - 7290 lm ↓	↑ 10530 lm - 10935 lm ↓
Output:	135 lm/W	135 lm/W	135 lm/W
CCT:	3000 K	3000 K	3000 K
CRI:	>90	>90	>90
Power:	↑ 30.0W/m - 30.0W/m ↓	↑ 60.0W - 60.0W ↓	↑ 90.0W - 90.0W ↓
Power Tot:	60.0W/m	120.0W	180.0W
Weight:	1.40 Kg/m	2.80 Kg	4.20 Kg

Alluminio/aluminium

Cover: Prismatico/prismatic - Satinato/Satin

DRIVER NON INCLUSO / NOT INCLUDED

CAVO ALIMENTAZIONE : 50 cm
ALIMENTATION CABLE : 50 cm

Lmax = 300cm

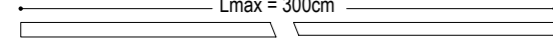

FINITURA STRUTTURA
FINISHES

- GRIGIO VESUVIO ANTHRACITE
- ARGILLA CLAY
- ARGENTO OPACO MATT SILVER
- BIANCO INTONACO/WHITE
- NERO CARAVAGGIO BLACK
- MOKA MOCHA
- ORO CALIFORNIA GOLD
- ARAMEN COPPER
- GRIGIO AVIO/GREY AVIO
- ARGENTO COMETA/SILVER COMET
- OTTONE VENEZIANO BRASS
- TITANIO/TITANIUM
- BRONZO RIACI/RIACI BRONZE
- VERDE COSTA/GREEN COAST
- TERRA SENESE SENESE EARTH
- CROMO/CHROME

DIFFUSORE
DIFFUSER

- SATINATA/SATIN
- PRISMATIZZATO PRISMATIC

	1 cm	200 cm	300 cm
CODICE CODE	1168100031	1168100230	1168100330
	1168101031	1168101230	1168101330
	1168102031	1168102230	1168102330
	1168103031	1168103230	1168103330
	1168104031	1168104230	1168104330
	1168105031	1168105230	1168105330
	1168109031	1168109230	1168109330
	1168110031	1168110230	1168110330
	1168111031	1168111230	1168111330
	1168112031	1168112230	1168112330
	1168113031	1168113230	1168113330
	1168114031	1168114230	1168114330
	1168115031	1168115230	1168115330
	1168116031	1168116230	1168116330
	1168117031	1168117230	1168117330
	1168108031	1168108230	

N.B./P.N.:
LUNGHEZZA MASSIMA VERSIONE CROMO = 2,00 m / MAXIMUM LENGTH CHROME VERSION = 2.00 m
TESTATE NON INCLUSE / DEAD ENDS NOT INCLUDED



COVER ALLUMINIO / ALUMINUM COVER

	1 cm	1 cm	
FINITURA STRUTTURA FINISHES	CODICE CODE	FINITURA STRUTTURA FINISHES	CODICE CODE
GRIGIO VESUVIO ANTHRACITE	1100500001	ARAMEN COPPER	1100510001
ARGILLA CLAY	1100501001	GRIGIO AVIO/GREY AVIO	1100511001
ARGENTO OPACO MATT SILVER	1100502001	ARGENTO COMETA/SILVER COMET	1100512001
BIANCO INTONACO/WHITE	1100503001	OTTONE VENEZIANO BRASS	1100513001
NERO CARAVAGGIO BLACK	1100504001	TITANIO/TITANIUM	1100514001
MOKA MOCHA	1100505001	BRONZO RIACI/RIACI BRONZE	1100515001
CROMO/CHROME	1100508001	VERDE COSTA/GREEN COAST	1100516001
ORO CALIFORNIA/GOLD	1100509001	TERRA SENESE SENESE EARTH	1100517001

TESTATE DI CHIUSURA / DEAD ENDS



FINITURA STRUTTURA FINISHES	CODICE CODE	FINITURA STRUTTURA FINISHES	CODICE CODE
GRIGIO VESUVIO ANTHRACITE	1100400000	ARAMEN COPPER	1100410000
ARGILLA CLAY	1100401000	GRIGIO AVIO/GREY AVIO	1100411000
ARGENTO OPACO MATT SILVER	1100402000	ARGENTO COMETA/SILVER COMET	1100412000
BIANCO INTONACO/WHITE	1100403000	OTTONE VENEZIANO BRASS	1100413000
NERO CARAVAGGIO BLACK	1100404000	TITANIO/TITANIUM	1100414000
MOKA MOCHA	1100405000	BRONZO RIACI/RIACI BRONZE	1100415000
CROMO/CHROME	1100408000	VERDE COSTA/GREEN COAST	1100416000
ORO CALIFORNIA/GOLD	1100409000	TERRA SENESE SENESE EARTH	1100417000

Il codice contiene 1 testata di chiusura con viti.
The code contains 1 closing warhead with screws.

**“rende realizzabile
qualsiasi progetto a parete”**

ZER035-P costruito in estruso di alluminio si avvale della tecnologia degli schermi in policarbonato per diffondere la luce per mezzo di LED al top, per qualità, resa cromatica, lumen emessi, ed accurata selezione della temperatura colore, scelta in base al progetto scenografico che vogliamo ottenere. ZER035-P offre una gamma di finiture e di accessori, i tagli lineari e a 45° o su MISURA, rendono realizzabile qualsiasi progetto a parete.

ZER035-P is made in extruded aluminium. Use polycarbonate technology for diffusing led light with high precision, use high quality like led, colour rendering, lumen output and accurate colour temperature for ensuring optimal results for each type of project. ZER035-P offers a wide gamma of finishing's and accessories, several lengths, 45°cuts or completely customized.



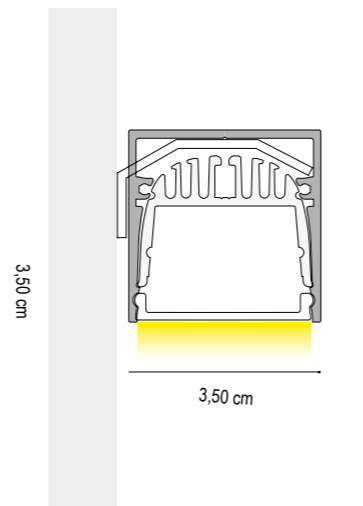

A RICHIESTA DISPONIBILE VERSIONE LUCE INDIRECTA/
INDIRECT LIGHT VERSION AVAILABLE ON REQUEST /

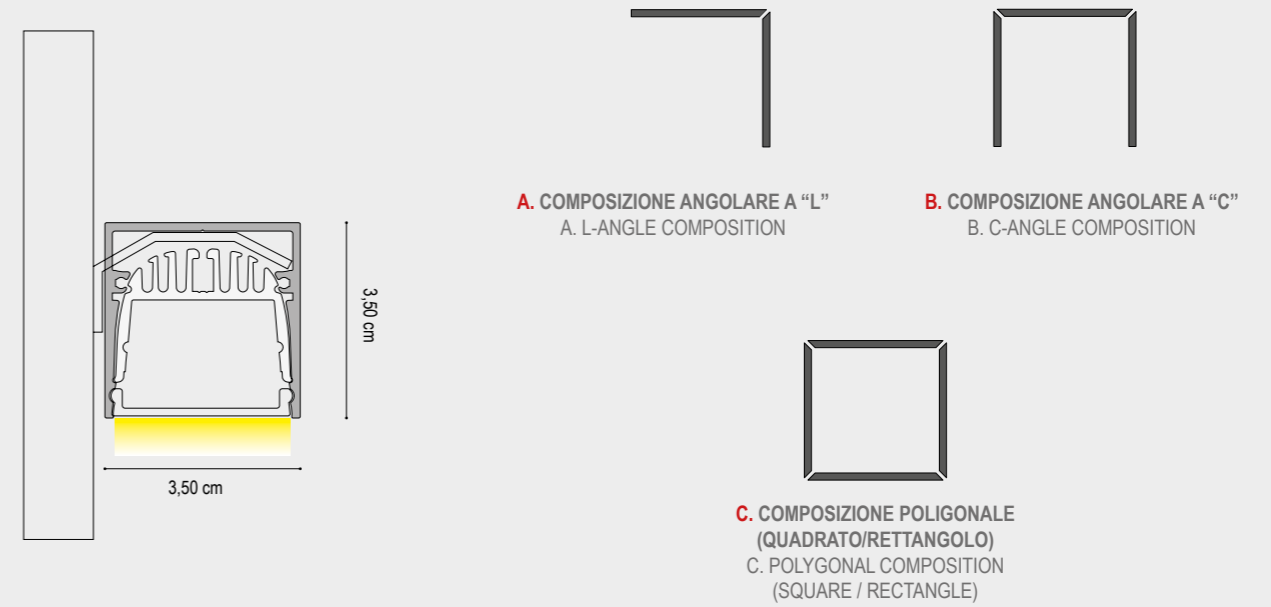

INSTALLAZIONE STAFFA A PARETE
WALL BRACKET INSTALLATION

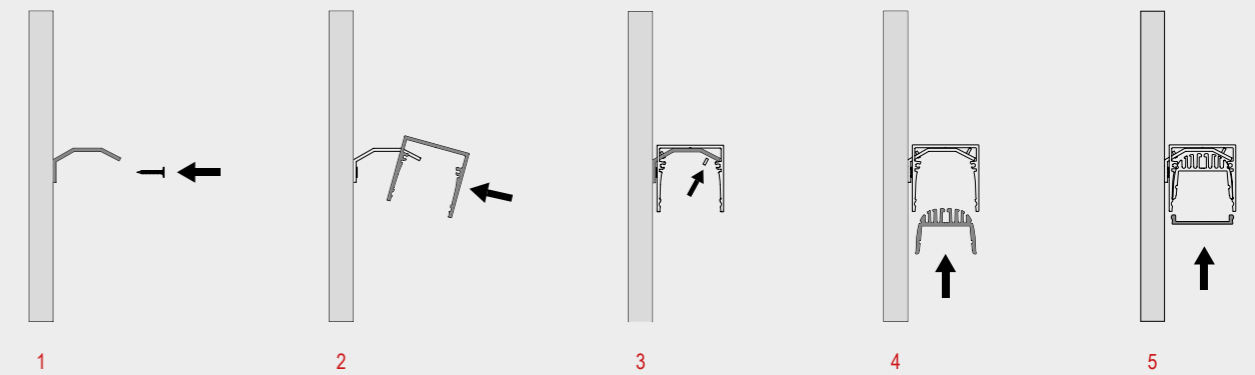

1. FISSARE LE STAFFE UTILIZZANDO SISTEMI DI FISSAGGIO IDONEI AL TIPO DI PARETE. PRESTARE ATTENZIONE ALL'ALINEAMENTO DELLE STAFFE PER UNA CORRETTA INSTALLAZIONE DEL PRODOTTO. IN CASO DI INSTALLAZIONE SU PARETE NON LINEARE, SI CONSIGLIA DI UTILIZZARE SUPPORTI DISTANZIALI AL FINE DI EVITARNE LA TORSIONE.
1. FIX THE BRACKETS USING FASTENING SYSTEMS SUITABLE FOR THE TYPE OF WALL. PAY ATTENTION TO THE ALIGNMENT OF THE BRACKETS FOR A CORRECT INSTALLATION OF THE PRODUCT. IN THE EVENT OF INSTALLATION ON A NON-LINEAR WALL, IT IS RECOMMENDED TO USE SPACER SUPPORTS IN ORDER TO AVOID TORSION.
2. SUL LATO DEL PROFILO RIVOLTO VERSO LA PARETE È PRESENTE UN'ASOLA. INSERIRE LA STAFFA NELL'ASOLA.
2. THERE IS A SLOT ON THE SIDE OF THE PROFILE FACING THE WALL. INSERT THE BRACKET IN THE SLOT.
3. BLOCCARE IL PROFILO ALLA STAFFA UTILIZZANDO GLI APPOSITI GRANI FILETTATI.
3. LOCK THE PROFILE TO THE BRACKET USING THE SPECIAL THREADED DOWELS.
4. INSERIRE IL DISSIPATORE IN ALLUMINIO. ATTENZIONE! ASSICURARSI DEL PERFETTO SCATTO TRA IL DISSIPATORE E IL PROFILO. UN'INSTALLAZIONE ERRATA PUÒ COMPROMETTERE LA TENUTA E LA DURABILITÀ DEL PRODOTTO.
4. INSERT THE ALUMINUM HEAT SINK. WARNING! MAKE SURE THE PERFECT SNAP BETWEEN THE HEAT SINK AND THE PROFILE. AN INCORRECT INSTALLATION MAY COMPROMISE THE SEALING AND DURABILITY OF THE PRODUCT.
5. INSERIRE LA COVER IN POLICARBONATO.
5. INSERT THE POLYCARBONATE COVER.

zero35 - p

led integrato

integrated led

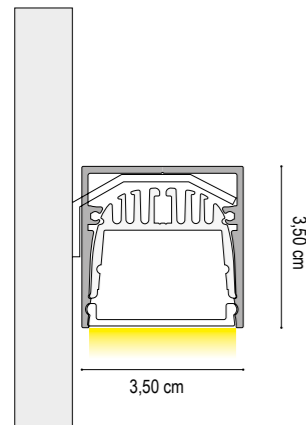

DATI TECNICI
TECHNICAL DATA

	1 cm	200 cm	300 cm
Nominal LED Flux:	2200 lm/m	4400 lm	6600 lm
Flux Tot:	1760 lm/m	3520 lm	5280 lm
Output:	110 lm/W	110 lm/W	110 lm/W
CCT:	3000 K	3000 K	3000 K
CRI:	>95	>95	>95
Power Tot:	20.0 W/m	40.0 W	60.0 W
Weight:	0.90 Kg/m	1.80 Kg	2.70 Kg

Alluminio/aluminium

Cover: Opale/opal

DRIVER NON INCLUSO / NOT INCLUDED

STAFFE DI FISSAGGIO A PARETE INCLUSE NEL CODICE
WALL MOUNTING BRACKETS INCLUDED IN THE CODE

CAVO ALIMENTAZIONE : 50 cm
ALIMENTATION CABLE : 50 cm

zero35 - p

led integrato

integrated led

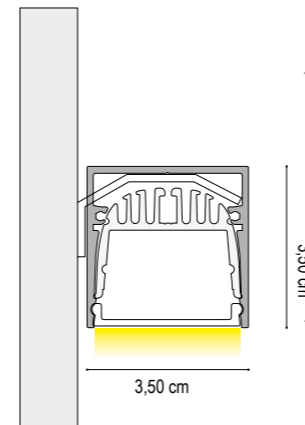

DATI TECNICI
TECHNICAL DATA

	1 cm	1 cm	1 cm
Nominal LED Flux:	2880 lm/m	3000 lm/m	3120 lm/m
Flux Tot:	2360 lm/m	2460 lm/m	2560 lm/m
Output:	120 lm/W	125 lm/W	130 lm/W
CCT:	2700 K	3000 K	3000 K
CRI:	>95	>95	>95
Power Tot:	24.0 W/m	24.0 W/m	24.0 W/m
Weight:	0.90 Kg/m	0.90 Kg/m	0.90 Kg/m

Alluminio/aluminium

Cover: Opale/opal

DRIVER NON INCLUSO / NOT INCLUDED

STAFFE DI FISSAGGIO A PARETE INCLUSE NEL CODICE
WALL MOUNTING BRACKETS INCLUDED IN THE CODE

CAVO ALIMENTAZIONE : 50 cm
ALIMENTATION CABLE : 50 cm

FINITURA STRUTTURA FINISHES	DIFFUSORE DIFFUSER	1 cm CODICE CODE	200 cm CODICE CODE	300 cm CODICE CODE
GRIGIO VESUVIO ANTHRACITE	OPALE/OPAL	1102600021	1102600220	1102600320
ARGILLA CLAY		1102601021	1102601220	1102601320
ARGENTO OPACO/MATT SILVER		1102602021	1102602220	1102602320
BIANCO INTONACO/WHITE		1102603021	1102603220	1102603320
NERO CARAVAGGIO BLACK		1102604021	1102604220	1102604320
MOKA MOCHA		1102605021	1102605220	1102605320
ORO CALIFORNIA/GOLD		1102609021	1102609220	1102609320
ARAMEN COPPER		1102610021	1102610220	1102610320
GRIGIO AVIO GREY AVIO		1102611021	1102611220	1102611320
ARGENTO COMETA/SILVER COMET		1102612021	1102612220	1102612320
OTTONE VENEZIANO BRASS		1102613021	1102613220	1102613320
TITANIO/TITANIUM		1102614021	1102614220	1102614320
BRONZO RIACI/RIACI BRONZE		1102615021	1102615220	1102615320
VERDE COSTA/GREEN COAST		1102616021	1102616220	1102616320
TERRA SENESE SENESE EARTH		1102617021	1102617220	1102617320
CROMO CHROME		1102608021	1102608220	

N.B./P.N.:

LUNGHEZZA MASSIMA VERSIONE CROMO = 2,00 m / MAXIMUM LENGTH CHROME VERSION = 2.00 m
TESTATE NON INCLUSE / DEAD ENDS NOT INCLUDED

FINITURA STRUTTURA FINISHES	DIFFUSORE DIFFUSER	1 cm - 2700K CODICE CODE	1 cm - 3000K CODICE CODE	1 cm - 4000K CODICE CODE
GRIGIO VESUVIO ANTHRACITE	OPALE/OPAL	110H600021	110H700021	110H800021
ARGILLA CLAY		110H601021	110H701021	110H801021
ARGENTO OPACO/MATT SILVER		110H602021	110H702021	110H802021
BIANCO INTONACO/WHITE		110H603021	110H703021	110H803021
NERO CARAVAGGIO BLACK		110H604021	110H704021	110H804021
MOKA MOCHA		110H605021	110H705021	110H805021
CROMO CHROME		110H608021	110H708021	110H808021
ORO CALIFORNIA/GOLD		110H609021	110H709021	110H809021
ARAMEN COPPER		110H610021	110H710021	110H810021
GRIGIO AVIO GREY AVIO		110H611021	110H711021	110H811021
ARGENTO COMETA/SILVER COMET		110H612021	110H712021	110H812021
OTTONE VENEZIANO BRASS		110H613021	110H713021	110H813021
TITANIO/TITANIUM		110H614021	110H714021	110H814021
BRONZO RIACI/RIACI BRONZE		110H615021	110H715021	110H815021
VERDE COSTA/GREEN COAST		110H616021	110H716021	110H816021
TERRA SENESE SENESE EARTH		110H617021	110H717021	110H817021

N.B./P.N.:

LUNGHEZZA MASSIMA VERSIONE CROMO = 2,00 m / MAXIMUM LENGTH CHROME VERSION = 2.00 m
TESTATE NON INCLUSE / DEAD ENDS NOT INCLUDED

PER LA TEMPERATURA COLORE 27K E 4K RIVOLGERSI AL NOSTRO UFFICIO TECNICO.
FOR 27K AND 4K COLOUR TEMPERATURE PLEASE CONTACT OUR TECHNICAL OFFICE.



zero35 - p

led integrato

integrated led

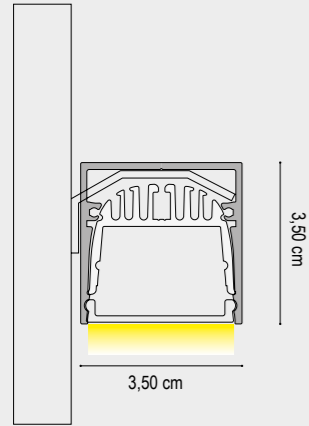

DATI TECNICI
TECHNICAL DATA

	1 cm	200 cm	300 cm
Nominal LED Flux:	2200 lm/m	4400 lm	6600 lm
Flux Tot:	1980 lm/m	3960 lm	5940 lm
Output:	110 lm/W	110 lm/W	110 lm/W
CCT:	3000 K	3000 K	3000 K
CRI:	>95	>95	>95
Power Tot:	20.0 W/m	40.0 W	60.0 W
Weight:	0.90 Kg/m	1.80 Kg	2.70 Kg

Alluminio/aluminium Cover: Prismatizzata/prismatic

DRIVER NON INCLUSO / NOT INCLUDED STAFFE DI FISSAGGIO A PARETE INCLUSE NEL CODICE
WALL MOUNTING BRACKETS INCLUDED IN THE CODE CAVO ALIMENTAZIONE : 50 cm
ALIMENTATION CABLE : 50 cm

zero35 - p

led integrato

integrated led

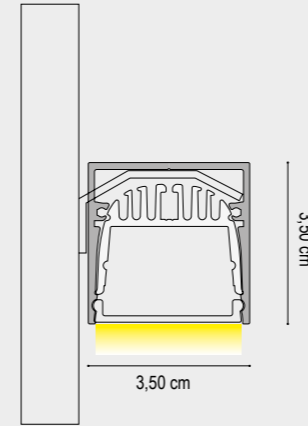

DATI TECNICI
TECHNICAL DATA

	1 cm	1 cm	1 cm
Nominal LED Flux:	2880 lm/m	3000 lm/m	3120 lm/m
Flux Tot:	2460 lm/m	2550 lm/m	2730 lm/m
Output:	120 lm/W	125 lm/W	130 lm/W
CCT:	2700 K	3000 K	4000 K
CRI:	>95	>95	>95
Power Tot:	24.0 W/m	24.0 W/m	24.0 W/m
Weight:	0.90 Kg/m	0.90 Kg/m	0.90 Kg/m

Alluminio/aluminium Cover: Prismatizzata/prismatic

DRIVER NON INCLUSO / NOT INCLUDED STAFFE DI FISSAGGIO A PARETE INCLUSE NEL CODICE
WALL MOUNTING BRACKETS INCLUDED IN THE CODE CAVO ALIMENTAZIONE : 50 cm
ALIMENTATION CABLE : 50 cm

		1 cm	200 cm	300 cm
FINITURA STRUTTURA FINISHES	DIFFUSORE DIFFUSER	CODICE CODE	CODICE CODE	CODICE CODE
GRIGIO VESUVIO ANTHRACITE	PRISMATIZZATO PRISMATIC	1102600041	1102600240	1102600340
ARGILLA CLAY		1102601041	1102601240	1102601340
ARGENTO OPACO/MATT SILVER		1102602041	1102602240	1102602340
BIANCO INTONACO/WHITE		1102603041	1102603240	1102603340
NERO CARAVAGGIO BLACK		1102604041	1102604240	1102604340
MOKA MOCHA		1102605041	1102605240	1102605340
ORO CALIFORNIA/GOLD		1102609041	1102609240	1102609340
ARAMEN COPPER		1102610041	1102610240	1102610340
GRIGIO AVIO/GREY AVIO		1102611041	1102611240	1102611340
ARGENTO COMETA/SILVER COMET		1102612041	1102612240	1102612340
OTTONE VENEZIANO/BRASS		1102613041	1102613240	1102613340
TITANIO/TITANIUM		1102614041	1102614240	1102614340
BRONZO RIACI/RIACI BRONZE		1102615041	1102615240	1102615340
VERDE COSTA/GREEN COAST		1102616041	1102616240	1102616340
TERRA SENESE/SENESE EARTH		1102617041	1102617240	1102617340
CROMO/CHROME		1102608041	1102608240	

N.B./P.N.:
LUNGHEZZA MASSIMA VERSIONE CROMO = 2,00 m / MAXIMUM LENGTH CHROME VERSION = 2.00 m
TESTATE NON INCLUSE / DEAD ENDS NOT INCLUDED

		1 cm - 2700K	1 cm - 3000K	1 cm - 4000K
FINITURA STRUTTURA FINISHES	DIFFUSORE DIFFUSER	CODICE CODE	CODICE CODE	CODICE CODE
GRIGIO VESUVIO ANTHRACITE	PRISMATIZZATO PRISMATIC	110H600041	110H700041	110H800041
ARGILLA CLAY		110H601041	110H701041	110H801041
ARGENTO OPACO/MATT SILVER		110H602041	110H702041	110H802041
BIANCO INTONACO/WHITE		110H603041	110H703041	110H803041
NERO CARAVAGGIO BLACK		110H604041	110H704041	110H804041
MOKA MOCHA		110H605041	110H705041	110H805041
CROMO/CHROME		110H608041	110H708041	110H808041
ORO CALIFORNIA/GOLD		110H609041	110H709041	110H809041
ARAMEN COPPER		110H610041	110H710041	110H810041
GRIGIO AVIO/GREY AVIO		110H611041	110H711041	110H811041
ARGENTO COMETA/SILVER COMET		110H612041	110H712041	110H812041
OTTONE VENEZIANO/BRASS		110H613041	110H713041	110H813041
TITANIO/TITANIUM		110H614041	110H714041	110H814041
BRONZO RIACI/RIACI BRONZE		110H615041	110H715041	110H815041
VERDE COSTA/GREEN COAST		110H616041	110H716041	110H816041
TERRA SENESE/SENESE EARTH		110H617041	110H717041	110H817041

N.B./P.N.:
LUNGHEZZA MASSIMA VERSIONE CROMO = 2,00 m / MAXIMUM LENGTH CHROME VERSION = 2.00 m
TESTATE NON INCLUSE / DEAD ENDS NOT INCLUDED

PER LA TEMPERATURA COLORE 27K E 4K RIVOLGERSI AL NOSTRO UFFICIO TECNICO.
FOR 27K AND 4K COLOUR TEMPERATURE PLEASE CONTACT OUR TECHNICAL OFFICE.

zero35 spot advanced

zero35 spot advanced

designer

luigi cerbone

“moduli costumizzabili”

ZER035 SPOT ADVANCE è un prodotto composto da moduli customizzabili che consentono di avere sul medesimo sistema lineare diverse sorgenti luminose. A seconda delle necessità si può richiedere l'installazione di moduli SPOT abbinati a moduli LED. Lo ZER035 SPOT ADVANCE è un prodotto multi installazione: sospensione e soffitto. È particolarmente adatto per illuminare spazi espositivi.

ZER035 SPOT ADVANCE is a product composed of customizable modules that allow you to have different light sources on the same linear system. Depending on your needs, you can request the installation of SPOT modules combined with LED modules. The ZER035 SPOT ADVANCE is a multi-installation product: suspension and ceiling. It is particularly suitable for illuminating exhibition spaces.

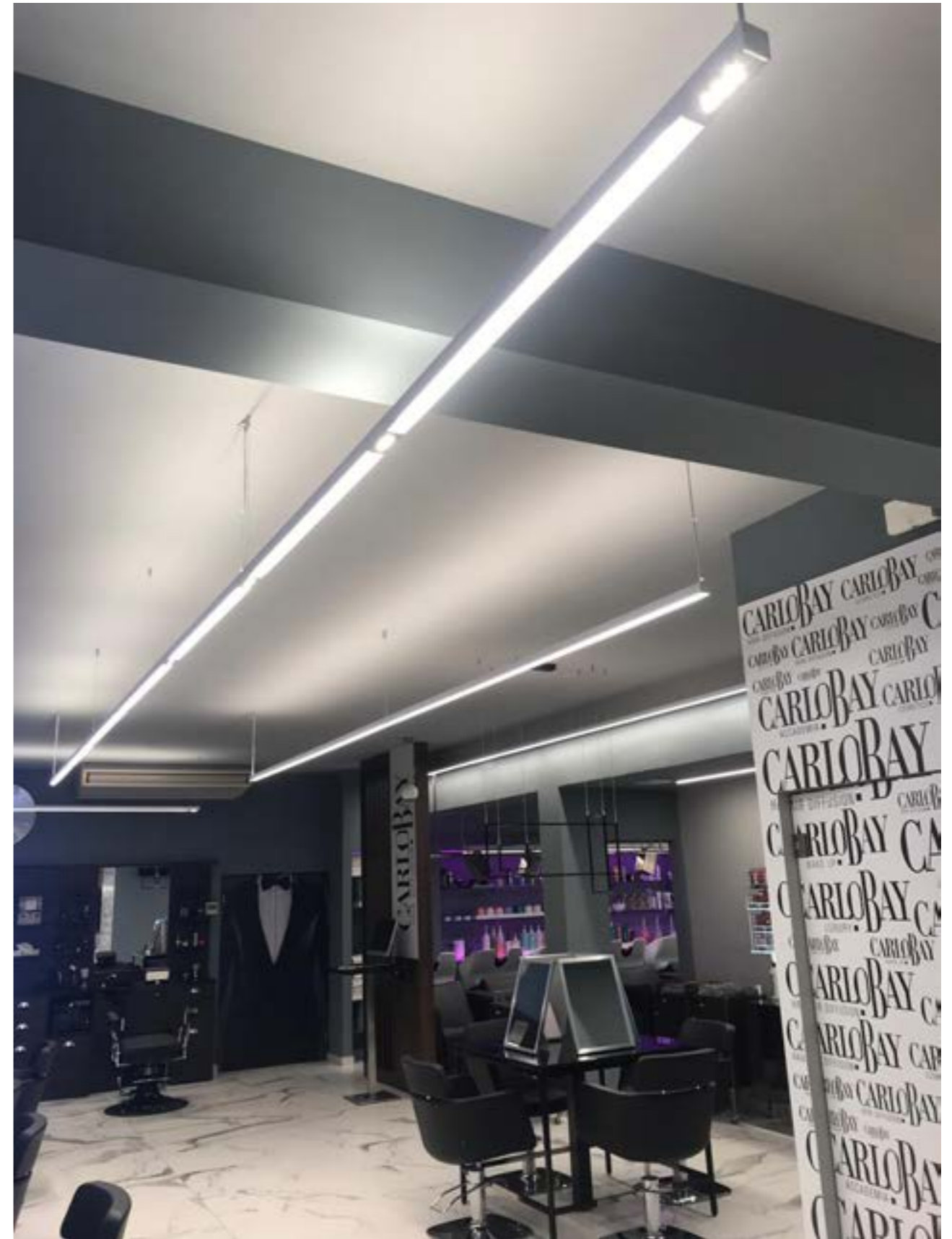

INSTALLAZIONE KIT DI SOSPENSIONE
SUSPENSION KIT INSTALLATION

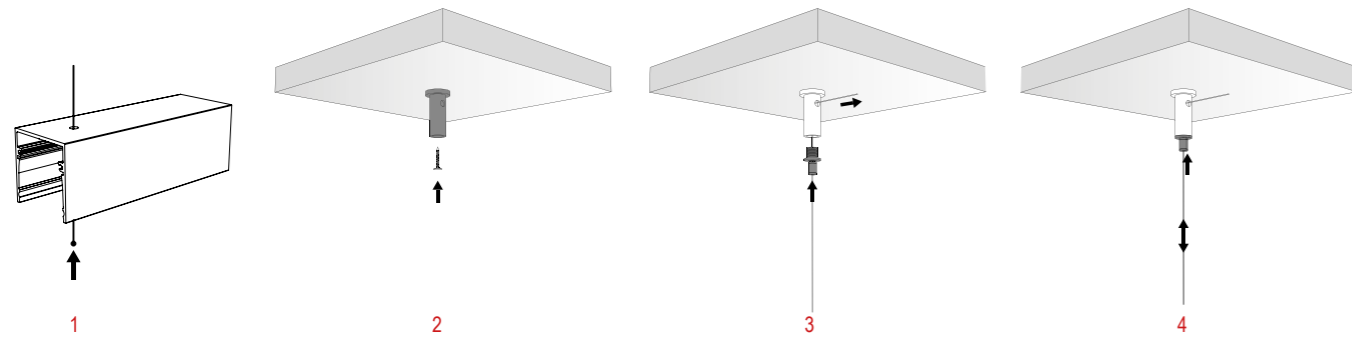

1. INSERIRE IL CAVO IN ACCIAIO NEL FORO PRATICATO SULLA PARTE SUPERIORE DEL PROFILO.
1. INSERT THE STEEL CABLE IN THE HOLE DRILLED ON THE TOP OF THE PROFILE.

2. FISSARE LA BOCCOLA A SOFFITTO PER MEZZO DI TASSELLI IDONEI AL SUPPORTO MURARIO.
2. FIX THE CEILING BUSHING BY MEANS OF SUITABLE DOWELS TO THE WALL SUPPORT.

3. PREMERE LE DUE ESTREMITÀ DEL PERNO PER INSERIRE IL CAVO IN ACCIAIO FACENDOLO PASSARE NELLA BOCCOLA A SOFFITTO.
3. PRESS THE TWO PARTS OF THE PIN TO INSERT THE STEEL CABLE AND PASS IT INTO THE CEILING BUSHING.

4. AVVITARE IL PERNO ALLA BOCCOLA. PREMERE LA PARTE INFERIORE DEL PERNO PER REGOLARE LA LUNGHEZZA DEL CAVO.
4. SCREW THE PIN TO THE BUSH. PRESS THE LOWER PART OF THE PIN TO ADJUST THE CABLE LENGTH.

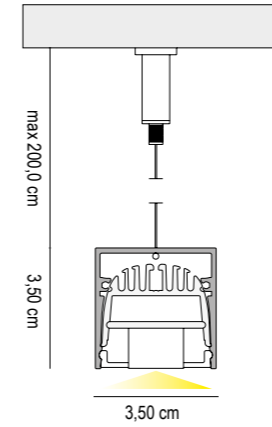
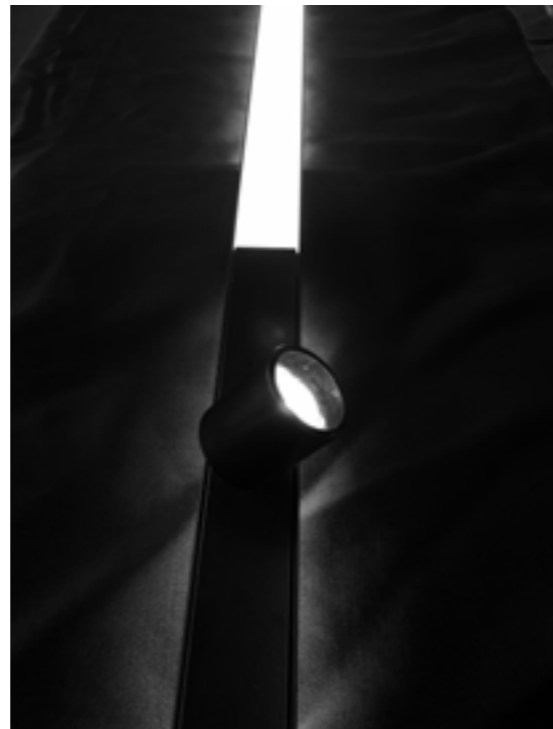
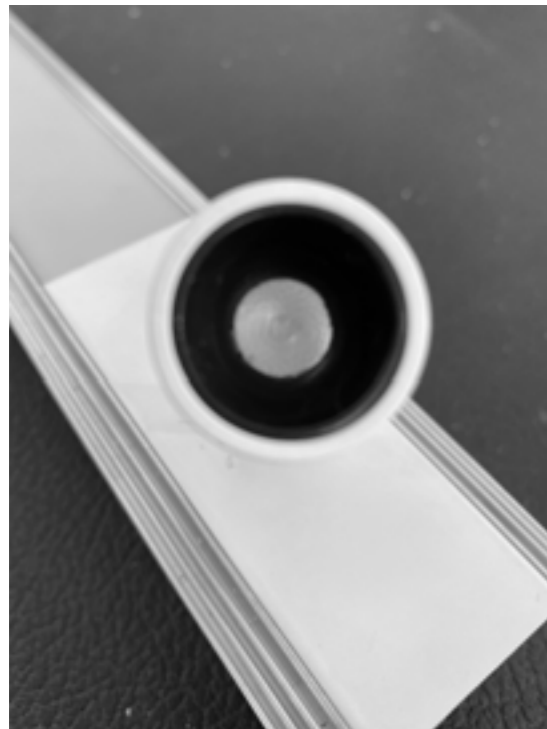

DATI TECNICI
TECHNICAL DATA

	120 cm (15+90+15)cm	150 cm (15+120+15)cm	180 cm (15+150+15)cm
Nominal LED Flux:	1980 lm	2640 lm	3300 lm
Nominal SPOT Flux:	1524 lm	1524 lm	1524 lm
Flux Tot:	2803 lm	3331 lm	3860 lm
Output:	105 lm/W + 121 lm/W	105 lm/W + 121 lm/W	105 lm/W + 121 lm/W
CCT:	3000 K	3000 K	3000 K
CRI:	>95	>95	>95
LED Power Tot:	18.0W	24.0W	30.0W
SPOT Power Tot:	18.0W (3W x 6)	18.0W (3W x 6)	18.0W (3W x 6)
Weight:	2.04 Kg	2.55 Kg	3.06 Kg

Alluminio/aluminium

Cover: Opale/opal

ARTICOLI INCLUSI NEL CODICE / ITEMS INCLUDED IN THE CODE:
DRIVER ON/OFF
COPPIA DI TESTATE DI CHIUSURA / PAIR OF CLOSING HEADS
KIT DI SOSPENSIONE / SUSPENSION KIT

FINITURA STRUTTURA
FINISHES

- GRIGIO VESUVIO ANTHRACITE
- ARGILLA CLAY
- BIANCO INTONACO/WHITE
- NERO CARAVAGGIO/BLACK
- MOKA MOCHA
- CROMO/CHROME
- ORO CALIFORNIA/GOLD
- ARAMEN COPPER
- GRIGIO AVIO/ GREY AVIO
- ARGENTO COMETA/SILVER COMET
- OTTONE VENEZIANO VENETIAN BRASS
- TITANIO/TITANIUM
- BRONZO RIACI/RIACI BRONZE
- VERDE COSTA/GREEN COAST
- TERRA SENESE SENESE EARTH
- NERO-CROMO/BLACK-CHROME

DIFFUSORE
DIFFUSER

OPALE/OPAL

	120 cm (15+90+15)cm	150 cm (15+120+15)cm	180 cm (15+150+15)cm
CODICE CODE	1108400120	1108400150	1108400180
	1108401120	1108401150	1108401180
	1108403120	1108403150	1108403180
	1108404120	1108404150	1108404180
	1108405120	1108405150	1108405180
	1108408120	1108408150	1108408180
	1108409120	1108409150	1108409180
	1108410120	1108410150	1108410180
	1108411120	1108411150	1108411180
	1108412120	1108412150	1108412180
	1108413120	1108413150	1108413180
	1108414120	1108414150	1108414180
	1108415120	1108415150	1108415180
	1108416120	1108416150	1108416180
	1108417120	1108417150	1108417180
	1108448120	1108448150	1108448180

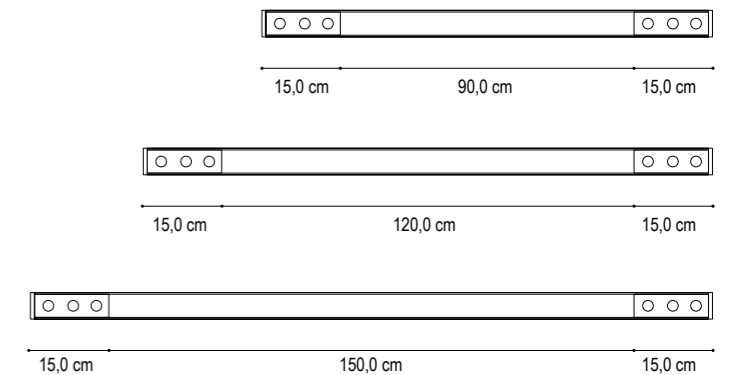

**“per progetti da incasso
a parete oppure a soffitto”**

ZER035 T costruito in estruso di alluminio si avvale della tecnologia degli schermi in policarbonato per diffondere la luce per mezzo di LED Tal top, per qualità, resa cromatica, lumen emessi, ed accurata selezione della temperatura colore, scelta in base al progetto scenografico che vogliamo ottenere. ZER035 T offre una gamma di finiture e di accessori, i tagli lineari e a 45° o su MISURA, rendono realizzabile qualsiasi progetto sia esso da incasso a parete oppure a soffitto.

ZER035 T is made in extruded aluminium. Use polycarbonate technology for diffusing led light with high precision, use high quality like led, colour rendering, lumen output and accurate colour temperature for ensuring optimal results for each type of project. ZER035 T offers a wide gamma of finishing's and accessories, several lengths, 45°cuts or completely customized. With ZER035 T it's possible to realize any kind of projects like wall-recessed or ceiling-recessed.



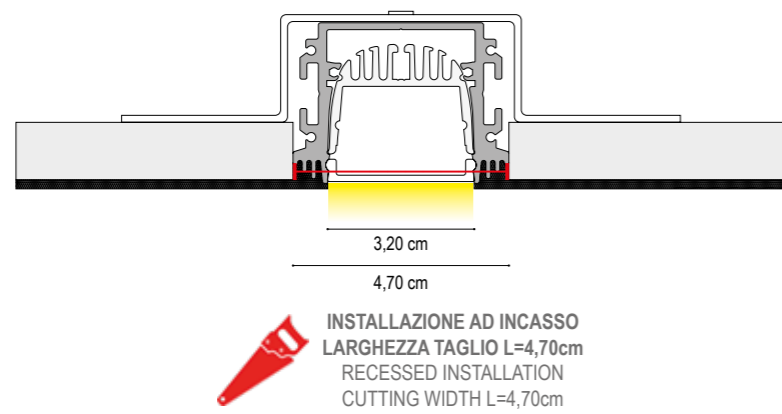

ATTENZIONE! IL PROFILO E' STATO DIMENSIONATO PER UN PANNELLO STANDARD IN CARTONGESSO DI SPESSORE 12,5 mm
WARNING! THE PROFILE HAS BEEN SIZED FOR A STANDARD PLASTERBOARD PANEL OF 12.5 mm THICKNESS

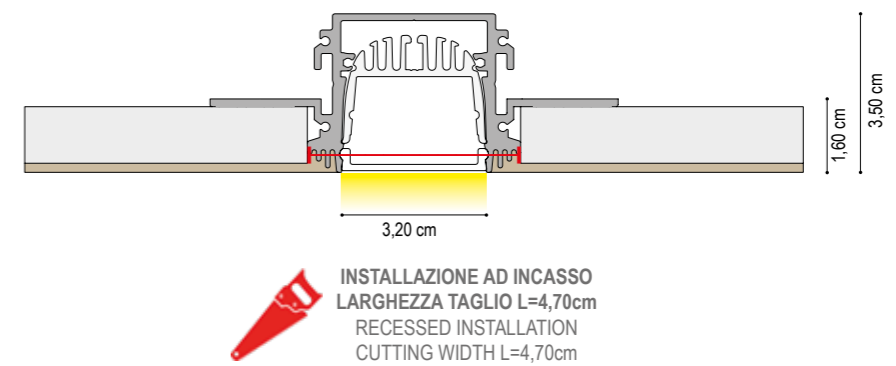

ATTENZIONE! IL PROFILO E' STATO DIMENSIONATO PER UN PANNELLO STANDARD IN CARTONGESSO DI SPESSORE 12,5 mm
WARNING! THE PROFILE HAS BEEN SIZED FOR A STANDARD PLASTERBOARD PANEL OF 12.5 mm THICKNESS

zero35 t

led integrato

integrated led

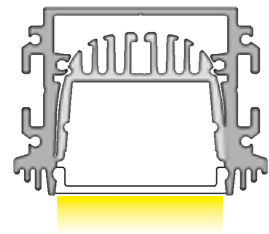

TESTATE NON INCLUDE
DEAD ENDS NOT INCLUDED

DATI TECNICI
TECHNICAL DATA

	1 cm	200 cm	300 cm
LED Flux Tot:	2200 lm/m	4400 lm	6600 lm
Flux Tot:	1680 lm/m	3360 lm	5040 lm
Output:	110 lm/W	110 lm/W	110 lm/W
CCT:	3000 K	3000 K	3000 K
CRI:	>95	>95	>95
Power Tot:	20.0 W/m	40.0 W	60.0 W
Weight:	0.90 Kg/m	1.80 Kg	2.70 Kg

Alluminio/aluminium

Cover: Opale/opal

FINITURA STRUTTURA
FINISHES

ALLUMINIO NATURALE/ALUMINUM

DIFFUSORE DIFFUSER	1 cm		200 cm		300 cm	
	CODICE CODE		CODICE CODE		CODICE CODE	
OPALE/OPAL	2247060001		2247060200		2247060300	

COVER POSA IN OPERA INCLUSA
(COVER MONOUSO PER PROTEGGERE IL PROFILO DURANTE LE FASI DI INSTALLAZIONE)
COVER INSTALLED IS INCLUDED
(DISPOSABLE COVER TO PROTECT THE PROFILE DURING THE INSTALLATION PHASES)

DATI TECNICI
TECHNICAL DATA

	1 cm	1 cm	1 cm
LED Flux Tot:	2880 lm/m	3000 lm/m	3330 lm/m
Flux Tot:	2360 lm/m	2460 lm/m	2730 lm/m
Output:	120 lm/W	125 lm/W	130 lm/W
CCT:	2700 K	3000 K	4000 K
CRI:	>95	>95	>95
Power Tot:	24.0 W/m	24.0 W/m	24.0 W/m
Weight:	0.90 Kg/m	0.90 Kg/m	0.90 Kg/m

Alluminio/aluminum Cover: Opale/opal

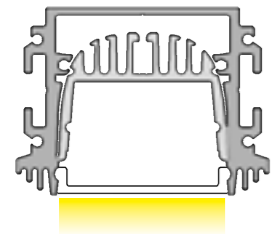

TESTATE NON INCLUDE
DEAD ENDS NOT INCLUDED

FINITURA STRUTTURA
FINISHES

ALLUMINIO NATURALE/ALUMINUM

DIFFUSORE DIFFUSER	1 cm		1 cm		1 cm	
	CODICE CODE		CODICE CODE		CODICE CODE	
OPALE/OPAL	22H6060001		22H7060001		22H8060001	

COVER POSA IN OPERA INCLUSA
(COVER MONOUSO PER PROTEGGERE IL PROFILO DURANTE LE FASI DI INSTALLAZIONE)
COVER INSTALLED IS INCLUDED
(DISPOSABLE COVER TO PROTECT THE PROFILE DURING THE INSTALLATION PHASES)

DATI TECNICI
TECHNICAL DATA

	1 cm	200 cm	300 cm
LED Flux Tot:	4050 lm/m	8100 lm	12150 lm
Flux Tot:	3240 lm/m	6480 lm	10656 lm
Output:	135 lm/W	135 lm/W	148 lm/W
CCT:	3000 K	3000 K	3000 K
CRI:	>90	>90	>90
Power Tot:	30.0 W/m	60.0 W	90.0 W
Weight:	0.90 Kg/m	1.80 Kg	2.70 Kg

Alluminio/aluminium

Cover: Opale/opal

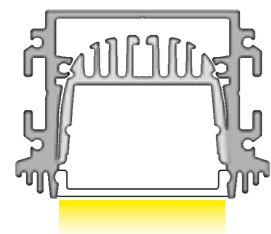

TESTATE NON INCLUDE
DEAD ENDS NOT INCLUDED

FINITURA STRUTTURA
FINISHES

ALLUMINIO NATURALE/ALUMINUM

DIFFUSORE DIFFUSER	1 cm		200 cm		300 cm	
	CODICE CODE		CODICE CODE		CODICE CODE	
OPALE/OPAL	2281060001		2281060200		2281060300	

COVER POSA IN OPERA INCLUSA
(COVER MONOUSO PER PROTEGGERE IL PROFILO DURANTE LE FASI DI INSTALLAZIONE)
COVER INSTALLED IS INCLUDED
(DISPOSABLE COVER TO PROTECT THE PROFILE DURING THE INSTALLATION PHASES)

zero35 t

led integrato

integrated led

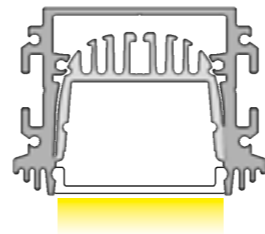

TESTATE NON INCLUDE
DEAD ENDS NOT INCLUDED

DATI TECNICI
TECHNICAL DATA

	1 cm	200 cm	300 cm
LED Flux Tot:	2200 lm/m	4400 lm	6600 lm
Flux Tot:	1980 lm/m	3960 lm	5940 lm
Output:	110 lm/W	110 lm/W	110 lm/W
CCT:	3000 K	3000 K	3000 K
CRI:	>95	>95	>95
Power Tot:	20.0 W/m	40.0 W	60.0 W
Weight:	0.90 Kg/m	1.80 Kg	2.70 Kg

Alluminio/aluminium

Cover: Prismatico/prismatic

FINITURA STRUTTURA
FINISHES

ALLUMINIO NATURALE/ALUMINUM

DIFFUSORE DIFFUSER	1 cm		200 cm		300 cm	
	CODICE CODE		CODICE CODE		CODICE CODE	
PRISMATIZZATO PRISMATIC	2247060031		2247060231		2247060331	

COVER POSA IN OPERA INCLUSA
(COVER MONOUSO PER PROTEGGERE IL PROFILO DURANTE LE FASI DI INSTALLAZIONE)
COVER INSTALLED IS INCLUDED
(DISPOSABLE COVER TO PROTECT THE PROFILE DURING THE INSTALLATION PHASES)

DATI TECNICI
TECHNICAL DATA

	1 cm	1 cm	1 cm
LED Flux Tot:	2880 lm/m	3000 lm/m	3330 lm/m
Flux Tot:	2450 lm/m	2550 lm/m	2830 lm/m
Output:	120 lm/W	125 lm/W	130 lm/W
CCT:	2700 K	3000 K	4000 K
CRI:	>95	>95	>95
Power Tot:	24.0 W/m	24.0 W/m	24.0 W/m
Weight:	0.90 Kg/m	0.90 Kg/m	0.90 Kg/m

Alluminio/aluminum Cover: Prismatico/prismatic

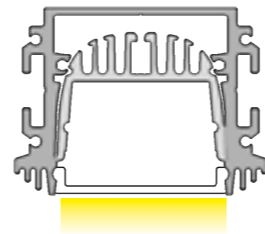

TESTATE NON INCLUDE
DEAD ENDS NOT INCLUDED

FINITURA STRUTTURA
FINISHES

ALLUMINIO NATURALE/ALUMINUM

DIFFUSORE DIFFUSER	1 cm		1 cm		1 cm	
	CODICE CODE		CODICE CODE		CODICE CODE	
PRISMATIZZATO PRISMATIC	22H6060031		22H7060031		22H8060031	

COVER POSA IN OPERA INCLUSA
(COVER MONOUSO PER PROTEGGERE IL PROFILO DURANTE LE FASI DI INSTALLAZIONE)
COVER INSTALLED IS INCLUDED
(DISPOSABLE COVER TO PROTECT THE PROFILE DURING THE INSTALLATION PHASES)

DATI TECNICI
TECHNICAL DATA

	1 cm	200 cm	300 cm
LED Flux Tot:	4050 lm/m	8880 lm	13320 lm
Flux Tot:	3510 lm/m	7020 lm	10530 lm
Output:	135 lm/W	135 lm/W	135 lm/W
CCT:	3000 K	3000 K	3000 K
CRI:	>90	>90	>90
Power Tot:	30.0 W/m	60.0 W	90.0 W
Weight:	0.90 Kg/m	1.80 Kg	2.70 Kg

Alluminio/aluminium

Cover: Prismatico/prismatic

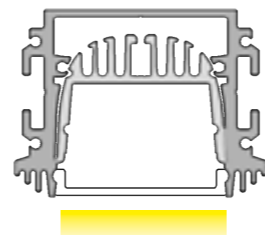

TESTATE NON INCLUDE
DEAD ENDS NOT INCLUDED

FINITURA STRUTTURA
FINISHES

ALLUMINIO NATURALE/ALUMINUM

DIFFUSORE DIFFUSER	1 cm		200 cm		300 cm	
	CODICE CODE		CODICE CODE		CODICE CODE	
PRISMATIZZATO PRISMATIC	2281060031		2281060231		2281060331	

COVER POSA IN OPERA INCLUSA
(COVER MONOUSO PER PROTEGGERE IL PROFILO DURANTE LE FASI DI INSTALLAZIONE)
COVER INSTALLED IS INCLUDED
(DISPOSABLE COVER TO PROTECT THE PROFILE DURING THE INSTALLATION PHASES)



zero35 t

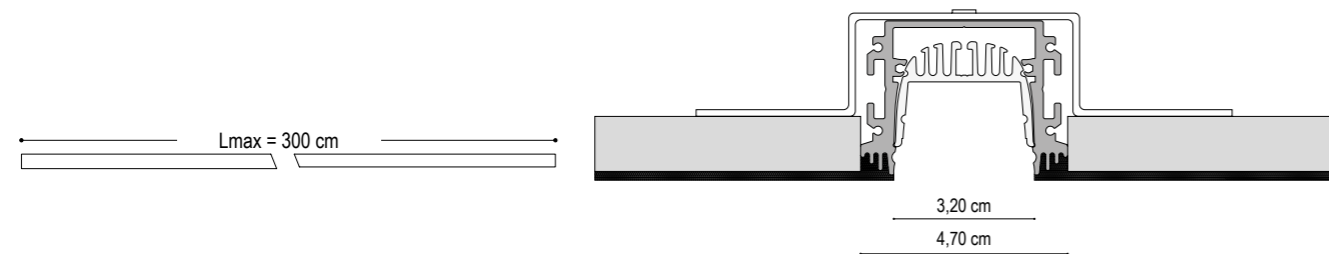

LED compatibili / LED compatibility

HIGH QUALITY CRI>90 CRI>95	HIGH OUTPUT CRI>90 CRI>95	HIGH EFFICIENT CRI>90 CRI>95	HIGH INTENSITY CRI>90 CRI>95	LOW POWER CRI>90	ULTRA SLIM CRI>90 CRI>95 CRI>97	RGB	RGB WHITE	RGB TW	TUNABLE WHITE
9,6W 14,4W 19,2W	12,3W 14,4W 19,2W 20W 24W	12,3W 14,4W 19,2W 20W 24W	24W 24W (700 LED)	6W	9,6W 12W 14,4W	14W	14W	14,4W 23W	19,2W

zero35 t

led non integrato

not integrated led

FINITURA STRUTTURA FINISHES	1 cm		200 cm		300 cm	
	CODICE CODE		CODICE CODE		CODICE CODE	
ALLUMINIO NATURALE/ALUMINUM	2203060031		2203060231		2203060331	

COVER POSA IN OPERA INCLUSA (COVER MONOUSO PER PROTEGGERE IL PROFILO DURANTE LE FASI DI INSTALLAZIONE)
COVER INSTALLED IS INCLUDED (DISPOSABLE COVER TO PROTECT THE PROFILE DURING THE INSTALLATION PHASES)



DIFFUSORE

DIFFUSORE DIFFUSER	1 cm		200 cm		300 cm		400 cm	
	CODICE CODE		CODICE CODE		CODICE CODE		CODICE CODE	
OPALE/OPAL	1100100001		1100100200		1100100300		1100100400	
SATINATA/SATIN	1100101001		1100101200		1100101300		1100101400	
PRISMATIZZATO/PRISMATIC	1100103001		1100103200		1100103300		1100103400	
							1100106400	

COVER ALLUMINIO / ALUMINUM COVER



1 cm		1 cm	
FINITURA STRUTTURA FINISHES	CODICE CODE	FINITURA STRUTTURA FINISHES	CODICE CODE
GRIGIO VESUVIO ANTHRACITE	1100500001	ARAMEN COPPER	1100510001
ARGILLA CLAY	1100501001	GRIGIO AVIO/ GREY AVIO	1100511001
ARGENTO OPACO/MATT SILVER	1100502001	ARGENTO COMETA/ SILVER COMET	1100512001
BIANCO INTONACO/WHITE	1100503001	OTTONE VENEZIANO BRASS	1100513001
NERO CARAVAGGIO/BLACK	1100504001	TITANIO/TITANIUM	1100514001
MOKA MOCHA	1100505001	BRONZO RIACI/RIACI BRONZE	1100515001
CROMO/CHROME	1100508001	VERDE COSTA/GREEN COAST	1100516001
ORO CALIFORNIA/GOLD	1100509001	TERRA SENESE/SENESE EARTH	1100517001

zero35 m

led integrato

integrated led

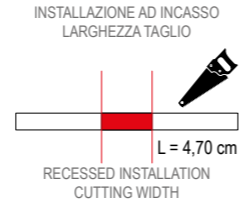
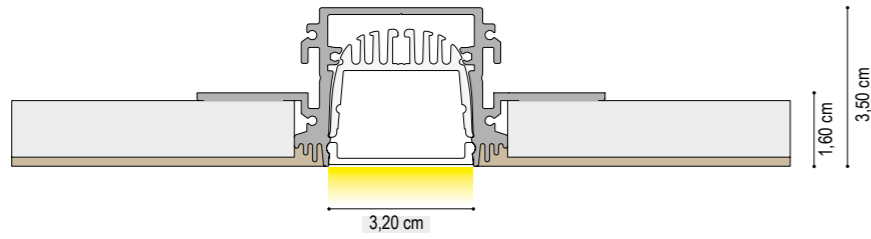

ATTENZIONE! IL PROFILO E' STATO DIMENSIONATO PER UN PANNELLO STANDARD IN CARTONGESSO DI SPESSORE 12,5 mm

WARNING! THE PROFILE HAS BEEN SIZED FOR A STANDARD PLASTERBOARD PANEL OF 12.5 mm THICKNESS

COVER POSA IN OPERA INCLUSA
(COVER MONOUSO PER PROTEGGERE IL PROFILO DURANTE LE FASI DI INSTALLAZIONE)

COVER INSTALLED IS INCLUDED
(DISPOSABLE COVER TO PROTECT THE PROFILE DURING THE INSTALLATION PHASES)

DATI TECNICI
TECHNICAL DATA

	1 cm	200 cm	300 cm
LED Flux Tot:	4050 lm/m	8100 lm	12150 lm
Flux Tot:	3240 lm/m	4860 lm	7290 lm
Output:	135 lm/W	135 lm/W	135 lm/W
CCT:	3000 K	3000 K	3000 K
CRI:	>90	>90	>90
Power Tot:	30.0 W/m	60.0 W	90.0 W
Weight:	0.90 Kg/m	1.80 Kg	2.70 Kg

Alluminio/aluminium

Cover: Opale/opal

TESTATE NON INCLUDE
DEAD ENDS NOT INCLUDED

FINITURA STRUTTURA FINISHES	DIFFUSORE DIFFUSER	1 cm		200 cm		300 cm	
		CODICE CODE		CODICE CODE		CODICE CODE	
ALLUMINIO NATURALE/ALUMINUM	OPALE/OPAL	228106M001		228106M200		228106M300	

COVER POSA IN OPERA INCLUSA
(COVER MONOUSO PER PROTEGGERE IL PROFILO DURANTE LE FASI DI INSTALLAZIONE)

COVER INSTALLED IS INCLUDED
(DISPOSABLE COVER TO PROTECT THE PROFILE DURING THE INSTALLATION PHASES)

DATI TECNICI
TECHNICAL DATA

	1 cm	200 cm	300 cm
LED Flux Tot:	3150 lm/m	6300 lm	9450 lm
Flux Tot:	2520 lm/m	5040 lm	7560 lm
Output:	105 lm/W	105 lm/W	105 lm/W
CCT:	3000 K	3000 K	3000 K
CRI:	>90	>90	>90
Power Tot:	30.0 W/m	60.0 W	90.0 W
Weight:	0.90 Kg/m	1.80 Kg	2.70 Kg

Alluminio/aluminium

Cover: Prismatico/prismatic

TESTATE NON INCLUDE
DEAD ENDS NOT INCLUDED

FINITURA STRUTTURA FINISHES	DIFFUSORE DIFFUSER	1 cm		200 cm		300 cm	
		CODICE CODE		CODICE CODE		CODICE CODE	
ALLUMINIO NATURALE/ALUMINUM	PRISMATIZZATO PRISMATIC	228106M031		228106M231		228106M331	

zero35 m

led non integrato

not integrated led

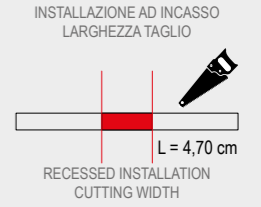
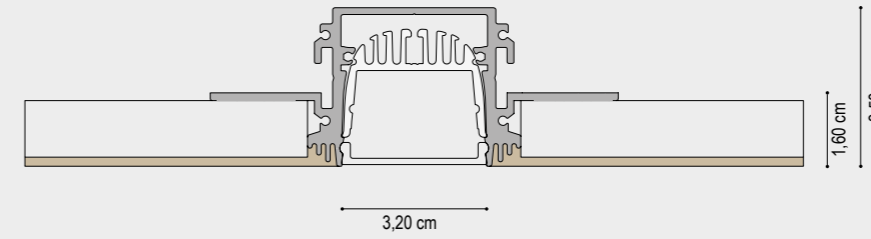

ATTENZIONE! IL PROFILO E' STATO DIMENSIONATO PER UN PANNELLO STANDARD IN CARTONGESSO DI SPESSORE 12,5 mm

WARNING! THE PROFILE HAS BEEN SIZED FOR A STANDARD PLASTERBOARD PANEL OF 12.5 mm THICKNESS

COVER POSA IN OPERA INCLUSA
(COVER MONOUSO PER PROTEGGERE IL PROFILO DURANTE LE FASI DI INSTALLAZIONE)

COVER INSTALLED IS INCLUDED
(DISPOSABLE COVER TO PROTECT THE PROFILE DURING THE INSTALLATION PHASES)

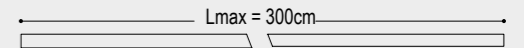

TESTATE NON INCLUDE
DEAD ENDS NOT INCLUDED

FINITURA STRUTTURA FINISHES	DIFFUSORE DIFFUSER	1 cm		200 cm		300 cm	
		CODICE CODE		CODICE CODE		CODICE CODE	
ALLUMINIO NATURALE/ALUMINUM	OPALE/OPAL	22CP06M001		22CP06M200		22CP06M300	

COVER POSA IN OPERA INCLUSA
(COVER MONOUSO PER PROTEGGERE IL PROFILO DURANTE LE FASI DI INSTALLAZIONE)

COVER INSTALLED IS INCLUDED
(DISPOSABLE COVER TO PROTECT THE PROFILE DURING THE INSTALLATION PHASES)

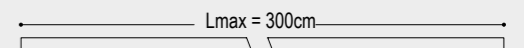

TESTATE NON INCLUDE
DEAD ENDS NOT INCLUDED

FINITURA STRUTTURA FINISHES	DIFFUSORE DIFFUSER	1 cm		200 cm		300 cm	
		CODICE CODE		CODICE CODE		CODICE CODE	
ALLUMINIO NATURALE/ALUMINUM	PRISMATIZZATO PRISMATIC	22CR06M001		22CR06M200		22CR06M300	



TESTATE DI CHIUSURA / DEAD ENDS



FINITURA STRUTTURA
FINISHES

ALLUMINIO NATURALE/ALUMINUM

CODICE
CODE

220406

Il codice contiene 1 testata di chiusura con viti.
The code contains 1 closing warhead with screws.

STAFFA DI FISSAGGIO A CARTONGESSO / MOUNTING CLIP FOR PLASTERBOARD

Accessorio che consente l'incasso del modello.
Accessory that allows the collection of the model.

Nel codice sono comprese le viti per il fissaggio del modello alla staffa. The code includes screws for fixing the model to the bracket.

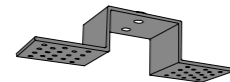

FINITURA
FINISHES

ALLUMINIO NATURALE/ALUMINUM

CODICE
CODE

220502

GIUNTI / JOINTS

GIUNTO LINEA CONTINUA / STRAIGHT JOINT

Accessorio per giunzioni meccaniche lineari
Accessory for linear mechanical joints

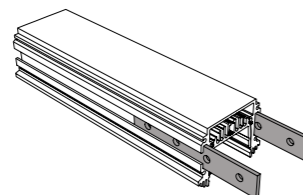

FINITURA
FINISHES

ALLUMINIO NATURALE/ALUMINUM

CODICE
CODE

X 1 PEZZO

220503

GIUNTO 90° ORIZZONTALE / HORIZONTAL JOINT 90°

Accessorio per giunzioni meccaniche con angolo 90°
Accessory for linear mechanical joints with 90° angle

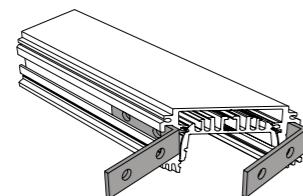

ALLUMINIO NATURALE/ALUMINUM

220500

GIUNTO 90° VERTICALE / VERTICAL JOINT 90°

Accessorio per giunzioni meccaniche con angolo 90°
Accessory for linear mechanical joints with 90° angle

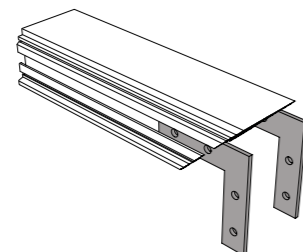

ALLUMINIO NATURALE/ALUMINUM

220501

ATTENZIONE: IL CODICE COMPRENDE 1 GIUNTO MECCANICO. L'IMMAGINE E' A PURO SCOPO ILLUSTRATIVO.
ATTENTION: THE CODE INCLUDES 1 MECHANICAL JOINT. THE IMAGE IS FOR ILLUSTRATIVE PURPOSE.

Nel codice sono compresi i grani per il fissaggio / The code includes the fixing grains

LAVORAZIONI / PROCESSING

DATI TECNICI
TECHNICAL DATA

CODICE
CODE

TAGLIO 90° ORIZZONTALE (PER ANGOLI FORMATI DA DUE PROFILI)
HORIZONTAL 90 ° CUT (FOR CORNERS MADE OF TWO PROFILES)

190X



TAGLIO 90° VERTICALE (PER ANGOLI FORMATI DA DUE PROFILI)
VERTICAL 90 ° CUT (FOR CORNERS MADE OF TWO PROFILES)

190Y

TAGLIO ANGOLARE CUSTOM (PER ANGOLI FORMATI DA DUE PROFILI)
CUSTOM CORNER CUT (FOR CORNERS MADE OF TWO PROFILES)

190N

ASOLA CUSTOM / SLOTCUSTOM

100N

FORO / HOLE

100F



CABLAGGIO - COLLAUDO - CE AL CENTIMETRO
INSTALLATION AND TESTING LED MODULE AT CENTIMETER

2201

CONNETTORE MASCHIO/FEMMINA
MALE/FEMALE CONNECTOR

98CFM



CONNETTORE MASCHIO/FEMMINA MONTATO NEL PRODOTTO MALE/
FEMALE CONNECTOR FITTED IN THE PRODUCT

98MFM



CAVO DI ALIMENTAZIONE 2X0,75 TONDO TRASPARENTE 1CM POWER
CABLE 2X0,75 ROUND TRANSPARENT 1CM

98CTT001



**“zero65 di luce diretta
zero65 x di luce diretta e indiretta”**

Il progetto ZERO65 nasce dall'esigenza di integrare le alimentazioni in un progetto, offre soluzioni innovative in ogni sua fase; dalla progettazione alla messa in opera, senza tra l'altro tralasciare l'aspetto illuminotecnico le cui tecniche sono indispensabili a garantire una luce diffusa o puntuale. Capaci, quindi, di generale flussi luminosi che trasmettano emozioni e calore in grado di aumentare il rapporto di benessere tra le persone e l'ambiente. Può essere installato da incasso a parete, plafone o sospensione i tagli su misura e a 45 gradi, le diverse finiture lo rendono estremamente flessibile.

ZERO65 with and without border is born on basis of need to include power supplies in a project. Offers innovative solutions in each phase of the project, beginning with the planning until the end with the installation and never leave out the lighting aspect, which's technology offers bright or spot light. Able to create emotional and warm illumination flows which increases the relationship between persons and environment. It can be installed like wall recessed, surface mounted or pendant. The customized lengths, the 45° cuts and the different colours makes it very flexible.



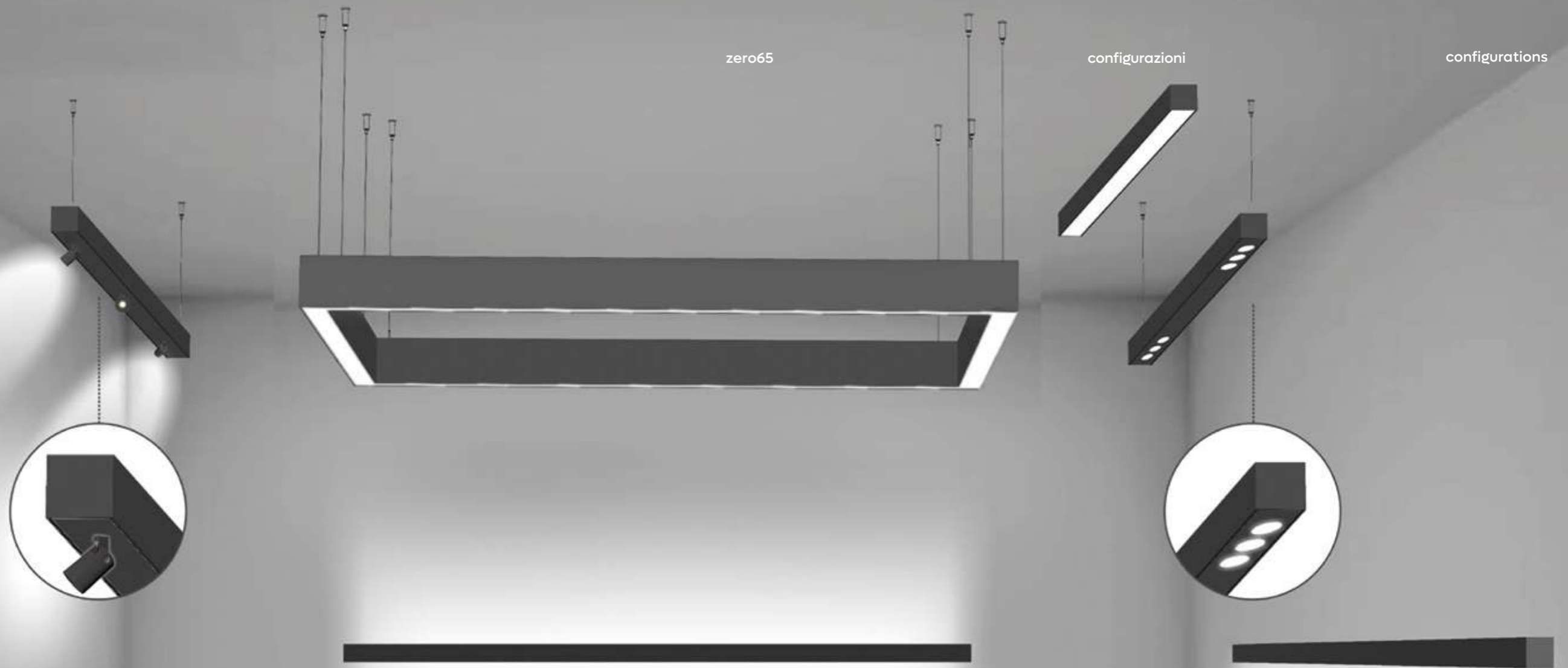

LE COMPOSIZIONI SOPRA RIPORTATE POSSONO ESSERE REALIZZATE PER INSTALLAZIONE A SOSPENSIONE / SOFFITTO-PARETE / INCASSO. PER LE COMPOSIZIONI POLIGONALI RIVOLGERSI AL NOSTRO REPARTO TECNICO.

THE ABOVE COMPOSITIONS CAN BE MADE FOR SUSPENSION / CEILING-WALL / RECESSED INSTALLATION. FOR POLYGONAL COMPOSITIONS, PLEASE CONTACT OUR TECHNICAL DEPARTMENT.

IL FISSAGGIO A SUPERFICIE NON PREVEDE UTILIZZO DI ACCESSORI. IL PRODOTTO ZERO65 SI INSTALLA A SUPERFICIE MEDIANTE UTILIZZO DI TASSELLI IDONEI AL TIPO DI MURATURA E FORANDO IL PROFILO ESTERNO IN ALLUMINIO. LA FORATURA DEL PROFILO PUÒ ESSERE RICHIESTA UTILIZZANDO IL CODICE 100F.

SURFACE MOUNTING DOES NOT INCLUDE THE USE OF ACCESSORIES. THE ZERO65 PRODUCT IS INSTALLED ON THE SURFACE BY USING DOWELS SUITABLE FOR THE TYPE OF MASONRY AND DRILLING THE EXTERNAL ALUMINUM PROFILE. PROFILE DRILLING CAN BE REQUIRED USING CODE 100F.



A. COMPOSIZIONE ANGOLARE A "L"
A. L-ANGLE COMPOSITION

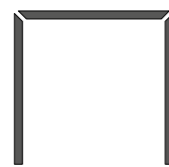

B. COMPOSIZIONE ANGOLARE A "C"
B. C-ANGLE COMPOSITION

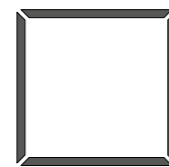

C. COMPOSIZIONE POLIGONALE (QUADRATO/RETTANGOLO)
C. POLYGONAL COMPOSITION (SQUARE / RECTANGLE)



D. COMPOSIZIONE POLIGONALE (PENTAGONO/ESAGONO)
D. POLYGONAL COMPOSITION (PENTAGON / HEX)

INSTALLAZIONE A SOSPENSIONE
SUSPENSION

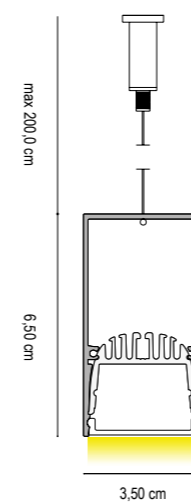

INSTALLAZIONE A SOFFITTO
CEILING INSTALLATION

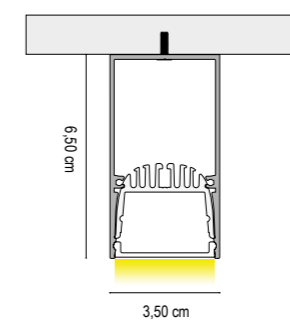

INSTALLAZIONE A INCASSO IN CARTONGESSO
RECESSED INSTALLATION IN PLASTERBOARD

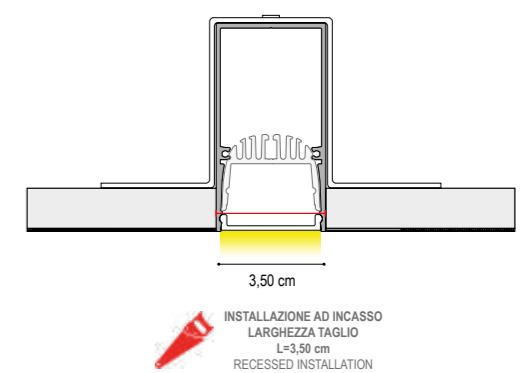

ATTENZIONE! GLI ACCESSORI PER L'INSTALLAZIONE A INCASSO SONO STATI DIMENSIONATI PER UN PANNELLO STANDARD IN CARTONGESSO DI SPESSORE 12,5 mm
WARNING! THE BUILT-IN INSTALLATION ACCESSORIES HAVE BEEN DIMENSIONED FOR A STANDARD PLASTERBOARD PANEL OF 12.5 mm THICKNESS

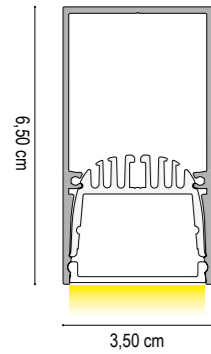

DATI TECNICI
TECHNICAL DATA

	1 cm	200 cm	300 cm
Nominal LED Flux:	2200 lm/m	4400 lm	6600 lm
Flux Tot:	1760 lm/m	3520 lm	5280 lm
Output:	110 lm/W	110 lm/W	110 lm/W
CCT:	3000 K	3000 K	3000 K
CRI:	>95	>95	>95
Power Tot:	20.0 W/m	40.0 W	60.0 W
Weight:	0.90 Kg/m	1.80 Kg	2.70 Kg

Alluminio/aluminium

Cover: Opale/opal

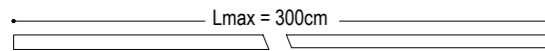

CAVO ALIMENTAZIONE : 50 cm
ALIMENTATION CABLE : 50 cm

FINITURA STRUTTURA
FINISHES

- GRIGIO VESUVIO ANTHRACITE
- ARGILLA CLAY
- ARGENTO OPACO/MATT SILVER
- BIANCO INTONACO/WHITE
- NERO CARAVAGGIO BLACK
- MOKA MOCHA
- ORO CALIFORNIA/GOLD
- ARAMEN COPPER
- GRIGIO AVIO GREY AVIO
- ARGENTO COMETA/SILVER COMET
- OTTONE VENEZIANO BRASS
- TITANIO/TITANIUM
- BRONZO RIACI/RIACI BRONZE
- VERDE COSTA/GREEN COAST
- TERRA SENESE SENESE EARTH
- CROMO/CHROME

DIFFUSORE
DIFFUSER

OPALE/OPAL

	1 cm	200 cm	300 cm
	DRIVER NON INCLUSO NOT INCLUDED	DRIVER ON/OFF INCLUSO INCLUDED	DRIVER ON/OFF INCLUSO INCLUDED
CODICE CODE	CODICE CODE	CODICE CODE	CODICE CODE
111260001	1112600200	1112600300	
1112601001	1112601200	1112601300	
1112602001	1112602200	1112602300	
1112603001	1112603200	1112603300	
1112604001	1112604200	1112604300	
1112605001	1112605200	1112605300	
1112609001	1112609200	1112609300	
1112610001	1112610200	1112610300	
1112611001	1112611200	1112611300	
1112612001	1112612200	1112612300	
1112613001	1112613200	1112613300	
1112614001	1112614200	1112614300	
1112615001	1112615200	1112615300	
1112616001	1112616200	1112616300	
1112617001	1112617200	1112617300	
1112608001	1112608200		

N.B./P.N.:
LUNGHEZZA MASSIMA VERSIONE CROMO = 2,00 m / MAXIMUM LENGTH CHROME VERSION = 2.00 m
TESTATE DI CHIUSURA NON INCLUSA / DEAD ENDS NOT INCLUDED

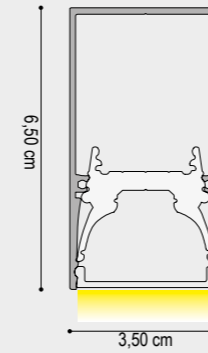

DATI TECNICI
TECHNICAL DATA

	1 cm	200 cm	300 cm
Nominal LED Flux:	2200 lm/m	4400 lm	6600 lm
Flux Tot:	1980 lm/m	3960 lm	5940 lm
Output:	110 lm/W	110 lm/W	110 lm/W
CCT:	3000 K	3000 K	3000 K
CRI:	>95	>95	>95
Power Tot:	20.0 W/m	40.0 W	60.0 W
Weight:	0.90 Kg/m	1.80 Kg	2.70 Kg

Alluminio/aluminium

Cover: Prismatico/prismatic

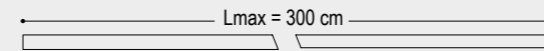

CAVO ALIMENTAZIONE : 50 cm
ALIMENTATION CABLE : 50 cm

FINITURA STRUTTURA
FINISHES

- GRIGIO VESUVIO ANTHRACITE
- ARGILLA CLAY
- ARGENTO OPACO/MATT SILVER
- BIANCO INTONACO/WHITE
- NERO CARAVAGGIO BLACK
- MOKA MOCHA
- ORO CALIFORNIA/GOLD
- ARAMEN COPPER
- GRIGIO AVIO GREY AVIO
- ARGENTO COMETA/SILVER COMET
- OTTONE VENEZIANO BRASS
- TITANIO/TITANIUM
- BRONZO RIACI/RIACI BRONZE
- VERDE COSTA/GREEN COAST
- TERRA SENESE SENESE EARTH
- CROMO/CHROME

DIFFUSORE
DIFFUSER

PRISMATIZZATO
PRISMATIC

	1 cm	200 cm	300 cm
	DRIVER NON INCLUSO NOT INCLUDED	DRIVER ON/OFF INCLUSO INCLUDED	DRIVER ON/OFF INCLUSO INCLUDED
CODICE CODE	CODICE CODE	CODICE CODE	CODICE CODE
1112600031	1112600230	1112600330	
1112601031	1112601230	1112601330	
1112602031	1112602230	1112602330	
1112603031	1112603230	1112603330	
1112604031	1112604230	1112604330	
1112605031	1112605230	1112605330	
1112609031	1112609230	1112609330	
1112610031	1112610230	1112610330	
1112611031	1112611230	1112611330	
1112612031	1112612230	1112612330	
1112613031	1112613230	1112613330	
1112614031	1112614230	1112614330	
1112615031	1112615230	1112615330	
1112616031	1112616230	1112616330	
1112617031	1112617230	1112617330	
1112608031	1112608230		

N.B./P.N.:
LUNGHEZZA MASSIMA VERSIONE CROMO = 2,00 m / MAXIMUM LENGTH CHROME VERSION = 2.00 m
TESTATE DI CHIUSURA NON INCLUSA / DEAD ENDS NOT INCLUDED

zero65

led integrato

integrated led

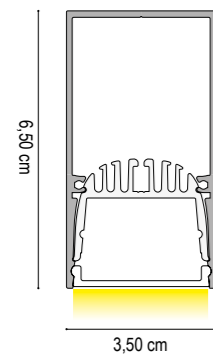

DATI TECNICI
TECHNICAL DATA

	1 cm	200 cm	300 cm
Nominal LED Flux:	3000 lm/m	6000 lm	9000 lm
Flux Tot:	2460 lm/m	4920 lm	7380 lm
Output:	125 lm/W	125 lm/W	125 lm/W
CCT:	3000 K	3000 K	3000 K
CRI:	>95	>95	>95
Power Tot:	24.0 W/m	48.0 W	72.0 W
Weight:	0.90 Kg/m	1.80 Kg	2.70 Kg

Alluminio/aluminium

Cover: Opale/opal

Lmax = 300 cm

CAVO ALIMENTAZIONE : 50 cm
ALIMENTATION CABLE : 50 cm

zero65

led integrato

integrated led

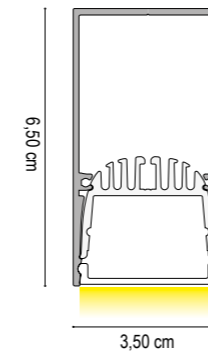

DATI TECNICI
TECHNICAL DATA

	1 cm	200 cm	300 cm
Nominal LED Flux:	4050 lm/m	8100 lm	12150 lm
Flux Tot:	3240 lm/m	6480 lm	9720 lm
Output:	135 lm/W	135 lm/W	135 lm/W
CCT:	3000 K	3000 K	3000 K
CRI:	>90	>90	>90
Power Tot:	30.0 W/m	60.0 W	90.0 W
Weight:	0.90 Kg/m	1.80 Kg	2.70 Kg

Alluminio/aluminium

Cover: Opale/opal

Lmax = 300cm

CAVO ALIMENTAZIONE : 50 cm
ALIMENTATION CABLE : 50 cm

FINITURA STRUTTURA FINISHES	DIFFUSORE DIFFUSER	DRIVER ON/OFF INCLUSO INCLUDED		
		1 cm DRIVER NON INCLUSO NOT INCLUDED	200 cm DRIVER ON/OFF INCLUSO INCLUDED	300 cm DRIVER ON/OFF INCLUSO INCLUDED
		CODICE CODE	CODICE CODE	CODICE CODE
GRIGIO VESUVIO ANTHRACITE	OPALE/OPAL	111H700001	111H700200	111H700300
ARGILLA CLAY		111H701001	111H701200	111H701300
ARGENTO OPACO MATT SILVER		111H702001	111H702200	111H702300
BIANCO INTONACO/WHITE		111H703001	111H703200	111H703300
NERO CARAVAGGIO BLACK		111H704001	111H704200	111H704300
MOKA MOCHA		111H705001	111H705200	111H705300
ORO CALIFORNIA/GOLD		111H709001	111H709200	111H709300
ARAMEN COPPER		111H710001	111H710200	111H710300
GRIGIO AVIO/GREY AVIO		111H711001	111H711200	111H711300
ARGENTO COMETA/SILVER COMET		111H712001	111H712200	111H712300
OTTONE VENEZIANO BRASS		111H713001	111H713200	111H713300
TITANIO/TITANIUM		111H714001	111H714200	111H714300
BRONZO RIACI/RIACI BRONZE		111H715001	111H715200	111H715300
VERDE COSTA/GREEN COAST		111H716001	111H716200	111H716300
TERRA SENESE SENESE EARTH		111H717001	111H717200	111H717300
CROMO/CHROME		111H708001	111H708200	

FINITURA STRUTTURA FINISHES	DIFFUSORE DIFFUSER	DRIVER ON/OFF INCLUSO INCLUDED		
		1 cm DRIVER NON INCLUSO NOT INCLUDED	200 cm DRIVER ON/OFF INCLUSO INCLUDED	300 cm DRIVER ON/OFF INCLUSO INCLUDED
		CODICE CODE	CODICE CODE	CODICE CODE
GRIGIO VESUVIO ANTHRACITE	OPALE/OPAL	1118100001	1118100200	1118100300
ARGILLA CLAY		1118101001	1118101200	1118101300
ARGENTO OPACO MATT SILVER		1118102001	1118102200	1118102300
BIANCO INTONACO/WHITE		1118103001	1118103200	1118103300
NERO CARAVAGGIO BLACK		1118104001	1118104200	1118104300
MOKA MOCHA		1118105001	1118105200	1118105300
ORO CALIFORNIA/GOLD		1118109001	1118109200	1118109300
ARAMEN COPPER		1118110001	1118110200	1118110300
GRIGIO AVIO/GREY AVIO		1118111001	1118111200	1118111300
ARGENTO COMETA/SILVER COMET		1118112001	1118112200	1118112300
OTTONE VENEZIANO BRASS		1118113001	1118113200	1118113300
TITANIO/TITANIUM		1118114001	1118114200	1118114300
BRONZO RIACI/RIACI BRONZE		1118115001	1118115200	1118115300
VERDE COSTA/GREEN COAST		1118116001	1118116200	1118116300
TERRA SENESE SENESE EARTH		1118117001	1118117200	1118117300
CROMO/CHROME		1118108001	1118108200	

N.B./P.N.:
LUNGHEZZA MASSIMA VERSIONE CROMO = 2,00 m / MAXIMUM LENGTH CHROME VERSION = 2.00 m
TESTATE DI CHIUSURA NON INCLUSA / DEAD ENDS NOT INCLUDED

N.B./P.N.:
LUNGHEZZA MASSIMA VERSIONE CROMO = 2,00 m / MAXIMUM LENGTH CHROME VERSION = 2.00 m
TESTATE DI CHIUSURA NON INCLUSA / DEAD ENDS NOT INCLUDED

“costruito in estruso di alluminio”

ZER065-p costruito in estruso di alluminio si avvale della tecnologia degli schermi in policarbonato per diffondere la luce per mezzo di LED al top, per qualità, resa cromatica, lumen emessi, ed accurata selezione della temperatura colore, scelta in base al progetto scenografico che vogliamo ottenere. ZER065-p offre una gamma di finiture e di accessori, i tagli lineari e a 45° o su MISURA, rendono realizzabile qualsiasi progetto a parete.

ZER065-p is made in extruded aluminium. Use polycarbonate technology for diffusing led light with high precision, use high quality like led, colour rendering, lumen output and accurate colour temperature for ensuring optimal results for each type of project. ZER065-P offers a wide gamma of finishing's and accessories, several lengths, 45° cuts or completely customized. With Zer035-P it's possible to realize any kind of wall projects.



zero65 p



zero65 p

installazione

installation

INSTALLAZIONE STAFFA A PARETE
WALL BRACKET INSTALLATION

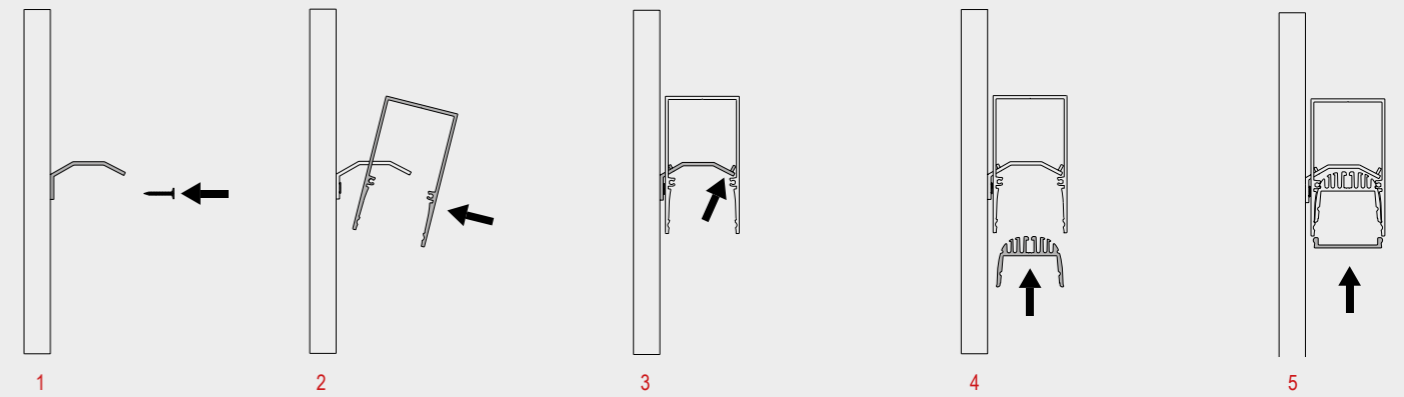

- 1.** FISSARE LE STAFFE UTILIZZANDO SISTEMI DI FISSAGGIO IDONEI AL TIPO DI PARETE. PRESTARE ATTENZIONE ALL'ALLINEAMENTO DELLE STAFFE PER UNA CORRETTA INSTALLAZIONE DEL PRODOTTO. IN CASO DI INSTALLAZIONE SU PARETE NON LINEARE, SI CONSIGLIA DI UTILIZZARE SUPPORTI DISTANZIALI AL FINE DI EVITARNE LA TORSIONE.
 - 2.** SUL LATO DEL PROFILO RIVOLTO VERSO LA PARETE È PRESENTE UN'ASOLA. INSERIRE LA STAFFA NELL'ASOLA.
 - 3.** BLOCCARE IL PROFILO ALLA STAFFA UTILIZZANDO GLI APPOSITI GRANI FILETTATI.
 - 4.** INSERIRE IL DISSIPATORE IN ALLUMINIO. ATTENZIONE! ASSICURARSI DEL PERFETTO SCATTO TRA IL DISSIPATORE E IL PROFILO. UN'INSTALLAZIONE ERRATA PUÒ COMPROMETTERE LA TENUTA E LA DURABILITÀ DEL PRODOTTO.
 - 5.** INSERIRE LA COVER IN POLICARBONATO.
1. FIX THE BRACKETS USING FASTENING SYSTEMS SUITABLE FOR THE TYPE OF WALL. PAY ATTENTION TO THE ALIGNMENT OF THE BRACKETS FOR A CORRECT INSTALLATION OF THE PRODUCT. IN THE EVENT OF INSTALLATION ON A NON-LINEAR WALL, IT IS RECOMMENDED TO USE SPACER SUPPORTS IN ORDER TO AVOID TORSION.
2. THERE IS A SLOT ON THE SIDE OF THE PROFILE FACING THE WALL. INSERT THE BRACKET IN THE SLOT.
3. LOCK THE PROFILE TO THE BRACKET USING THE SPECIAL THREADED DOWELS.
4. INSERT THE ALUMINUM HEAT SINK. WARNING! MAKE SURE THE PERFECT SNAP BETWEEN THE HEAT SINK AND THE PROFILE. AN INCORRECT INSTALLATION MAY COMPROMISE THE SEALING AND DURABILITY OF THE PRODUCT.
5. INSERT THE POLYCARBONATE COVER.

zero65p

configurazioni

configurations

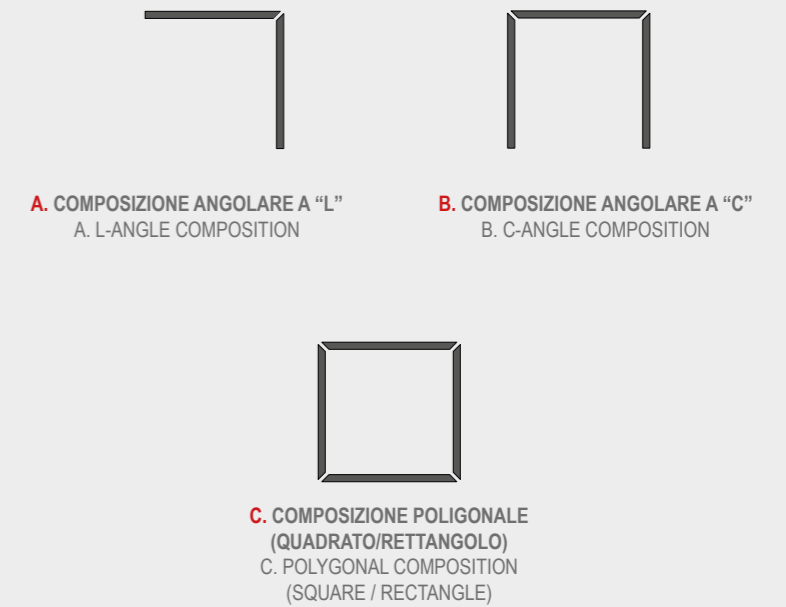
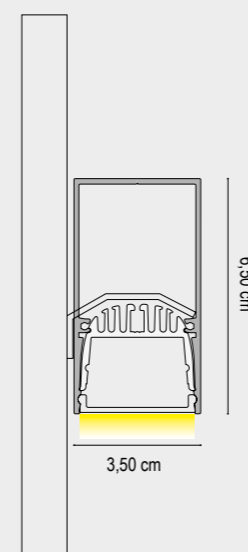

zero65 p

led integrato

integrated led

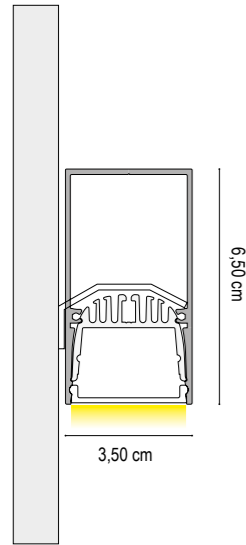

DATI TECNICI
TECHNICAL DATA

	1 cm	200 cm	300 cm
Nominal LED Flux:	2200 lm/m	4400 lm	6600 lm
Flux Tot:	1680 lm/m	3360 lm	5040 lm
Output:	105 lm/W	105 lm/W	105 lm/W
CCT:	3000 K	3000 K	3000 K
CRI:	>95	>95	>95
Power Tot:	20.0 W/m	40.0 W	60.0 W
Weight:	0.90 Kg/m	1.80 Kg	2.70 Kg

Alluminio/aluminium

Cover: Opale/opal

STAFFE DI FISSAGGIO A PARETE INCLUSE NEL CODICE
WALL MOUNTING BRACKETS INCLUDED IN THE CODE

CAVO ALIMENTAZIONE : 50 cm
ALIMENTATION CABLE : 50 cm

zero65 p

led integrato

integrated led

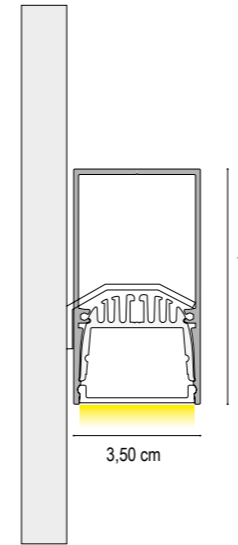

DATI TECNICI
TECHNICAL DATA

	1 cm	200 cm	300 cm
Nominal LED Flux:	3000 lm/m	6000 lm	9000 lm
Flux Tot:	2460 lm/m	4920 lm	7380 lm
Output:	125 lm/W	125 lm/W	125 lm/W
CCT:	3000 K	3000 K	3000 K
CRI:	>95	>95	>95
Power Tot:	24.0 W/m	48.0 W	78.0 W
Weight:	0.90 Kg/m	1.80 Kg	2.70 Kg

Alluminio/aluminium

Cover: Opale/opal

STAFFE DI FISSAGGIO A PARETE INCLUSE NEL CODICE
WALL MOUNTING BRACKETS INCLUDED IN THE CODE

CAVO ALIMENTAZIONE : 50 cm
ALIMENTATION CABLE : 50 cm

FINITURA STRUTTURA FINISHES	DIFFUSORE DIFFUSER	CODICE CODE		
		1 cm DRIVER NON INCLUSO NOT INCLUDED	200 cm DRIVER ON/OFF INCLUSO INCLUDED	300 cm DRIVER ON/OFF INCLUSO INCLUDED
GRIGIO VESUVIO ANTHRACITE	OPALE/OPAL	1112600021	1112600220	1112600320
ARGILLA CLAY		1112601021	1112601220	1112601320
ARGENTO OPACO MATT SILVER		1112602021	1112602220	1112602320
BIANCO INTONACO/WHITE		1112603021	1112603220	1112603320
NERO CARAVAGGIO BLACK		1112604021	1112604220	1112604320
MOKA MOCHA		1112605021	1112605220	1112605320
ORO CALIFORNIA/GOLD		1112609021	1112609220	1112609320
ARAMEN COPPER		1112610021	1112610220	1112610320
GRIGIO AVIO/ GREY AVIO		1112611021	1112611220	1112611320
ARGENTO COMETA/SILVER COMET		1112612021	1112612220	1112612320
OTTONE VENEZIANO BRASS		1112613021	1112613220	1112613320
TITANIO/TITANIUM		1112614021	1112614220	1112614320
BRONZO RIACI/RIACI BRONZE		1112615021	1112615220	1112615320
VERDE COSTA/GREEN COAST		1112616021	1112616220	1112616320
TERRA SENESE SENESE EARTH		1112617021	1112617220	1112617320
CROMO/CHROME		1112608021	1112608220	

N.B./P.N.:

LUNGHEZZA MASSIMA VERSIONE CROMO = 2,00 m / MAXIMUM LENGTH CHROME VERSION = 2.00 m
TESTATE DI CHIUSURA NON INCLUSE / DEAD ENDS NOT INCLUDED

FINITURA STRUTTURA FINISHES	DIFFUSORE DIFFUSER	CODICE CODE		
		1 cm DRIVER NON INCLUSO NOT INCLUDED	200 cm DRIVER ON/OFF INCLUSO INCLUDED	300 cm DRIVER ON/OFF INCLUSO INCLUDED
GRIGIO VESUVIO ANTHRACITE	OPALE/OPAL	111H700021	111H700220	111H700320
ARGILLA CLAY		111H701021	111H701220	111H701320
ARGENTO OPACO MATT SILVER		111H702021	111H702220	111H702320
BIANCO INTONACO/WHITE		111H703021	111H703220	111H703320
NERO CARAVAGGIO BLACK		111H704021	111H704220	111H704320
MOKA MOCHA		111H705021	111H705220	111H705320
ORO CALIFORNIA/GOLD		111H709021	111H709220	111H709320
ARAMEN COPPER		111H710021	111H710220	111H710320
GRIGIO AVIO/ GREY AVIO		111H711021	111H711220	111H711320
ARGENTO COMETA/SILVER COMET		111H712021	111H712220	111H712320
OTTONE VENEZIANO BRASS		111H713021	111H713220	111H713320
TITANIO/TITANIUM		111H714021	111H714220	111H714320
BRONZO RIACI/RIACI BRONZE		111H715021	111H715220	111H715320
VERDE COSTA/GREEN COAST		111H716021	111H716220	111H716320
TERRA SENESE SENESE EARTH		111H717021	111H717220	111H717320
CROMO/CHROME		111H708021	111H708220	

N.B./P.N.:

LUNGHEZZA MASSIMA VERSIONE CROMO = 2,00 m / MAXIMUM LENGTH CHROME VERSION = 2.00 m
TESTATE DI CHIUSURA NON INCLUSE / DEAD ENDS NOT INCLUDED



zero65 p

led integrato

integrated led

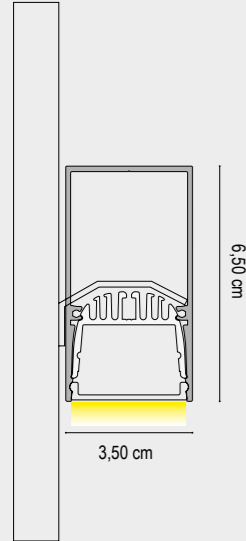

DATI TECNICI
TECHNICAL DATA

	1 cm	200 cm	300 cm
Nominal LED Flux:	2200 lm/m	4400 lm	6600 lm
Flux Tot:	1680 lm/m	3360 lm	5040 lm
Output:	105 lm/W	105 lm/W	105 lm/W
CCT:	3000 K	3000 K	3000 K
CRI:	>90	>90	>90
Power Tot:	20.0 W/m	40.0 W	60.0 W
Weight:	0.90 Kg/m	1.80 Kg	2.70 Kg

Alluminio/aluminium Cover: Prismatico/prismatic

STAFFE DI FISSAGGIO A PARETE INCLUSE NEL CODICE
WALL MOUNTING BRACKETS INCLUDED IN THE CODE

CAVO ALIMENTAZIONE : 50 cm
ALIMENTATION CABLE : 50 cm

zero65 p

led integrato

integrated led

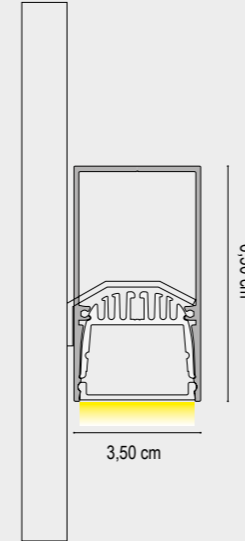

DATI TECNICI
TECHNICAL DATA

	1 cm	200 cm	300 cm
Nominal LED Flux:	3000 lm/m	6000 lm	9000 lm
Flux Tot:	2460 lm/m	4920 lm	7380 lm
Output:	125 lm/W	125 lm/W	125 lm/W
CCT:	3000 K	3000 K	3000 K
CRI:	>95	>95	>95
Power Tot:	24.0 W/m	48.0 W	72.0 W
Weight:	0.90 Kg/m	1.80 Kg	2.70 Kg

Alluminio/aluminium Cover: Prismatico/prismatic

STAFFE DI FISSAGGIO A PARETE INCLUSE NEL CODICE
WALL MOUNTING BRACKETS INCLUDED IN THE CODE

CAVO ALIMENTAZIONE : 50 cm
ALIMENTATION CABLE : 50 cm

FINITURA STRUTTURA FINISHES	DIFFUSORE DIFFUSER	1 cm			200 cm			300 cm		
		DRIVER NON INCLUSO NOT INCLUDED	CODICE CODE	DRIVER ON/OFF INCLUSO INCLUDED	CODICE CODE	DRIVER ON/OFF INCLUSO INCLUDED	CODICE CODE			
GRIGIO VESUVIO ANTHRACITE	PRISMATIZZATO PRISMATIC		1112600041		1112600240		1112600340			
ARGILLA CLAY			1112601041		1112601240		1112601340			
ARGENTO OPACO MATT SILVER			1112602041		1112602240		1112602340			
BIANCO INTONACO/WHITE			1112603041		1112603240		1112603340			
NERO CARAVAGGIO BLACK			1112604041		1112604240		1112604340			
MOKA MOCHA			1112605041		1112605240		1112605340			
ORO CALIFORNIA/GOLD			1112609041		1112609240		1112609340			
ARAMEN COPPER			1112610041		1112610240		1112610340			
GRIGIO AVIO/ GREY AVIO			1112611041		1112611240		1112611340			
ARGENTO COMETA/SILVER COMET			1112612041		1112612240		1112612340			
OTTONE VENEZIANO BRASS			1112613041		1112613240		1112613340			
TITANIO/TITANIUM			1112614041		1112614240		1112614340			
BRONZO RIACI/RIACI BRONZE			1112615041		1112615240		1112615340			
VERDE COSTA/GREEN COAST			1112616041		1112616240		1112616340			
TERRA SENESE SENESE EARTH			1112617041		1112617240		1112617340			
CROMO/CHROME			1112608041		1112608240					

N.B./P.N.:
LUNGHEZZA MASSIMA VERSIONE CROMO = 2,00 m / MAXIMUM LENGTH CHROME VERSION = 2.00 m
TESTATE DI CHIUSURA NON INCLUSE / DEAD ENDS NOT INCLUDED

FINITURA STRUTTURA FINISHES	DIFFUSORE DIFFUSER	1 cm			200 cm			300 cm		
		DRIVER NON INCLUSO NOT INCLUDED	CODICE CODE	DRIVER ON/OFF INCLUSO INCLUDED	CODICE CODE	DRIVER ON/OFF INCLUSO INCLUDED	CODICE CODE			
GRIGIO VESUVIO ANTHRACITE	PRISMATIZZATO PRISMATIC		111H700041		111H700242		111H700342			
ARGILLA CLAY			111H701041		111H701242		111H701342			
ARGENTO OPACO MATT SILVER			111H702041		111H702242		111H702342			
BIANCO INTONACO/WHITE			111H703041		111H703242		111H703342			
NERO CARAVAGGIO BLACK			111H704041		111H704242		111H704342			
MOKA MOCHA			111H705041		111H705242		111H705342			
ORO CALIFORNIA/GOLD			111H709041		111H709242		111H709342			
ARAMEN COPPER			111H710041		111H710242		111H710342			
GRIGIO AVIO/ GREY AVIO			111H711041		111H711242		111H711342			
ARGENTO COMETA/SILVER COMET			111H712041		111H712242		111H712342			
OTTONE VENEZIANO BRASS			111H713041		111H713242		111H713342			
TITANIO/TITANIUM			111H714041		111H714242		111H714342			
BRONZO RIACI/RIACI BRONZE			111H715041		111H715242		111H715342			
VERDE COSTA/GREEN COAST			111H716041		111H716242		111H716342			
TERRA SENESE SENESE EARTH			111H717041		111H717242		111H717342			
CROMO/CHROME			111H708041		111H708242					

N.B./P.N.:
LUNGHEZZA MASSIMA VERSIONE CROMO = 2,00 m / MAXIMUM LENGTH CHROME VERSION = 2.00 m
TESTATE DI CHIUSURA NON INCLUSE / DEAD ENDS NOT INCLUDED

zero65 - zero65 p

led non integrato

not integrated led



zero65 - zero65 p

led non integrato

not integrated led

	1 cm	200 cm	300 cm	400 cm
DIFFUSORE DIFFUSER	CODICE CODE	CODICE CODE	CODICE CODE	CODICE CODE
OPALE/OPAL	110010001	110010020	110010030	110010040
SATINATA/SATIN	110010101	110010120	110010130	110010140
PRISMATIZZATO	110010301	110010320	110010330	110010340
ECLISSI/ ECLIPSE	110010601	110010620	110010630	110010640

	10 m
DIFFUSORE DIFFUSER	CODICE CODE
OPALE/OPAL	110010399
PRISMATIZZATO	110010399

FINITURA STRUTTURA
FINISHES

- GRIGIO VESUVIO ANTHRACITE
- ARGILLA CLAY
- ARGENTO OPACO/MATT SILVER
- BIANCO INTONACO/WHITE
- NERO CARAVAGGIO BLACK
- MOKA MOCHA
- ORO CALIFORNIA GOLD
- ARAMEN COPPER
- GRIGIO AVIO/GREY AVIO
- ARGENTO COMETA/SILVER COMET
- OTTONE VENEZIANO BRASS
- TITANIO/TITANIUM
- BRONZO RIACI/RIACI BRONZE
- VERDE COSTA/GREEN COAST
- TERRA SENESE SENESE EARTH
- CROMO/CHROME

	1 cm	200 cm	300 cm
CODICE CODE	CODICE CODE	CODICE CODE	CODICE CODE
111020001	111020020	111020030	
111020101	111020120	111020130	
111020201	111020220	111020230	
111020301	111020320	111020330	
111020401	111020420	111020430	
111020501	111020520	111020530	
111020901	111020920	111020930	
111021001	111021020	111021030	
111021101	111021120	111021130	
111021201	111021220	111021230	
111021301	111021320	111021330	
111021401	111021420	111021430	
111021501	111021520	111021530	
111021601	111021620	111021630	
111021701	111021720	111021730	
111020801	111020820		

N.B./P.N.:
LUNGHEZZA MASSIMA VERSIONE CROMO = 2,00 m / MAXIMUM LENGTH CHROME VERSION = 2.00 m

LED compatibili / LED compatibility

HIGH QUALITY CRI>90 CRI>95	HIGH OUTPUT CRI>90 CRI>95	HIGH EFFICIENT CRI>90 CRI>95	HIGH INTENSITY CRI>90 CRI>95	LOW POWER CRI>90	ULTRA SLIM CRI>90 CRI>95 CRI>97	RGB	RGB WHITE	RGB TW	TUNABLE WHITE
9,6W 14,4W 19,2W	12,3W 14,4W 19,2W 20W 24W	12,3W 14,4W 19,2W 20W 24W	24W 24W (700 LED)	6W	9,6W 12W 14,4W	14W	14W	14,4W 23W	19,2W

zero65

aluminum cover

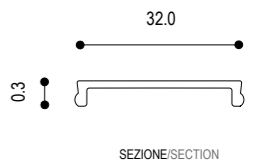
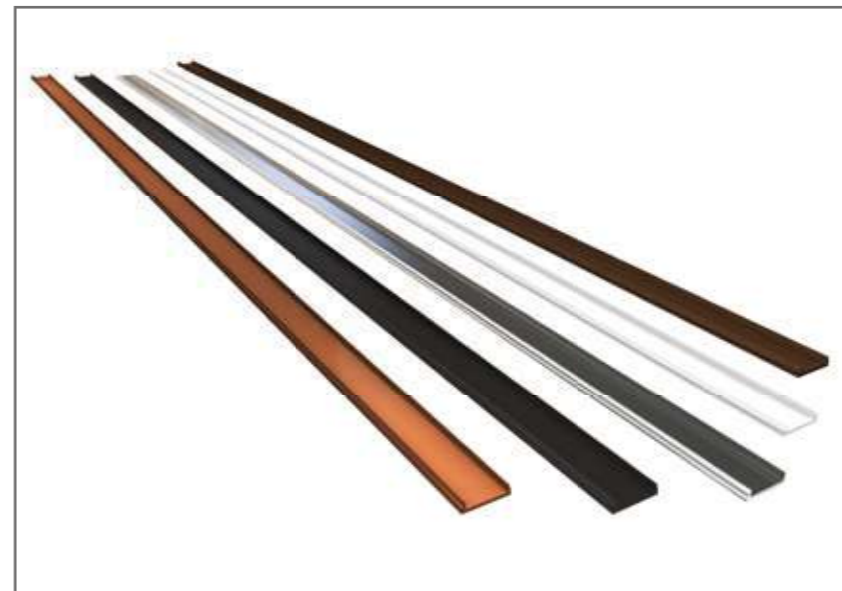

	1 cm	1 cm	
FINITURA STRUTTURA FINISHES	CODICE CODE	FINITURA STRUTTURA FINISHES	CODICE CODE
GRIGIO VESUVIO ANTHRACITE	110050001	ARAMEN COPPER	110051001
ARGILLA CLAY	110050101	ARGENTO COMETA/SILVER COMET	110051101
ARGENTO OPACO/MATT SILVER	110050201	GRIGIO AVIO/GREY AVIO	110051201
BIANCO INTONACO/WHITE	110050301	OTTONE VENEZIANO BRASS	110051301
NERO CARAVAGGIO BLACK	110050401	TITANIO/TITANIUM	110051401
MOKA MOCHA	110050501	BRONZO RIACI/RIACI BRONZE	110051501
CROMO/CHROME	110050801	VERDE COSTA/GREEN COAST	110051601
ORO CALIFORNIA GOLD	110050901	TERRA SENESE SENESE EARTH	110051701

TESTATE DI CHIUSURA / DEAD ENDS

FINITURA STRUTTURA FINISHES	CODICE CODE	FINITURA STRUTTURA FINISHES	CODICE CODE
GRIGIO VESUVIO ANTHRACITE	1110400000	ARAMEN COPPER	1110410000
ARGILLA CLAY	1110401000	GRIGIO AVIO/GREY AVIO	1110411000
ARGENTO OPACO/MATT SILVER	1110402000	ARGENTO COMETA/SILVER COMET	1110412000
BIANCO INTONACO/WHITE	1110403000	OTTONE VENEZIANO BRASS	1110413000
NERO CARAVAGGIO BLACK	1110404000	TITANIO/TITANIUM	1110414000
MOKA MOCHA	1110405000	BRONZO RIACI/RIACI BRONZE	1110415000
CROMO CHROME	1110408000	VERDE COSTA/GREEN COAST	1110416000
ORO CALIFORNIA/GOLD	1110409000	TERRA SENESE SENESE EARTH	1110417000

Il codice contiene 1 testata di chiusura con viti.
The code contains 1 closing warhead with screws.

TESTATE DI CHIUSURA CON LOGO / DEAD ENDS WITH LOGO

FINITURA STRUTTURA FINISHES	CODICE CODE	FINITURA STRUTTURA FINISHES	CODICE CODE
GRIGIO VESUVIO ANTHRACITE	1110600000	GRIGIO AVIO/GREY AVIO	1110611000
ARGILLA CLAY	1110601000	ARGENTO COMETA/SILVER COMET	1110612000
BIANCO INTONACO/WHITE	1110603000	OTTONE VENEZIANO BRASS	1110613000
NERO CARAVAGGIO BLACK	1110604000	TITANIO/TITANIUM	1110614000
MOKA MOCHA	1110605000	BRONZO RIACI/RIACI BRONZE	1110615000
CROMO CHROME	1110608000	VERDE COSTA/GREEN COAST	1110616000
ORO CALIFORNIA/GOLD	1110609000	TERRA SENESE SENESE EARTH	1110617000
ARAMEN COPPER	1110610000		

Il codice contiene 1 testata di chiusura.
The code contains 1 closing warhead.

STAFFA DI FISSAGGIO A CARTONGESSO / MOUNTING CLIP FOR PLASTERBOARD

Accessorio che consente l'incasso del modello.
Accessory that allows the collection of the model.

Nel codice sono comprese le viti per il fissaggio del modello alla staffa. The code includes screws for fixing the model to the bracket.

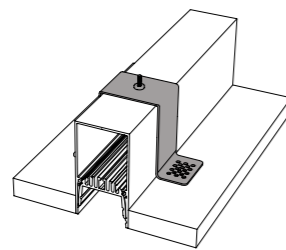

FINITURA FINISHES	CODICE CODE
ALLUMINIO NATURALE/ALUMINUM	1110500002

KIT DI SOSPENSIONE / SUSPENSION KIT

ARTICOLI INCLUSI NEL CODICE
ARTICLES INCLUDED IN THE CODE

Cavo in acciaio 2,00 m con puntalino
2.00 m steel cable with tip
Boccola cromata con regolazione millimetrica
Chrome bush with millimeter adjustment

Cavo in acciaio 3,00m con puntalino
3.00m steel cable with tip

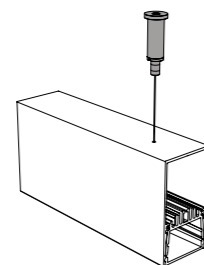

FINITURA FINISHES	CODICE CODE
CROMO CHROME	1100508200
	1100508F30

GIUNTI / JOINTS

	FINITURA FINISHES	CODICE CODE
GIUNTO LINEA CONTINUA / STRAIGHT JOINT Accessorio per giunzioni meccaniche lineari Accessory for linear mechanical joints	ALLUMINIO NATURALE/ALUMINUM	1110506001
GIUNTO 90° ORIZZONTALE / HORIZONTAL JOINT 90° Accessorio per giunzioni meccaniche con angolo 90° Accessory for linear mechanical joints with 90° angle	ALLUMINIO NATURALE/ALUMINUM	1110506002
GIUNTO ANGOLARE A T / ANGULAR T-JOINT Accessorio per giunzioni meccaniche a T Accessory for mechanical T-junctions	ALLUMINIO NATURALE/ALUMINUM	1110506003
GIUNTO ANGOLARE A X / ANGULAR X-JOINT Accessorio per giunzioni meccaniche a X Accessory for mechanical X-junctions	ALLUMINIO NATURALE/ALUMINUM	1110506004

Nel codice sono compresi i grani per il fissaggio / The code includes the fixing grains

LAVORAZIONI / PROCESSING

DATI TECNICI TECHNICAL DATA	CODICE CODE
TAGLIO 90° ORIZZONTALE (PER ANGOLI FORMATI DA DUE PROFILI) HORIZONTAL 90° CUT (FOR CORNERS MADE OF TWO PROFILES)	190X
TAGLIO ANGOLARE CUSTOM (PER ANGOLI FORMATI DA DUE PROFILI) CUSTOM CORNER CUT (FOR CORNERS MADE OF TWO PROFILES)	190N
ASOLA CUSTOMIZZATA / CUSTOM SLOT	100N
CABLAGGIO - COLLAUDO - CE AL CENTIMETRO INSTALLATION AND TESTING LED MODULE AT CENTIMETER	1111
CONNETTORE MASCHIO/FEMMINA MALE/FEMALE CONNECTOR	98CFM
CONNETTORE MASCHIO/FEMMINA MONTATO NEL PRODOTTO MALE/ FEMALE CONNECTOR FITTED IN THE PRODUCT	98MFM
MONTAGGIO CABLAGGIO COLLAUDO CE DRIVER ON OFF 60W MOUNTING WIRING TESTING CE MARKING DRIVER ON OFF 60W	1050A
MONTAGGIO CABLAGGIO COLLAUDO CE DRIVER ON OFF 96W MOUNTING WIRING TESTING CE MARKING DRIVER ON OFF 96W	1096A
MONTAGGIO CABLAGGIO COLLAUDO CE DRIVER DIM DALI PUSH 60W MOUNTING WIRING TESTING CE MARKING DIM DRIVER DALI PUSH 60W	1060D
MONTAGGIO CABLAGGIO COLLAUDO CE DRIVER DIM DALI PUSH 100W MOUNTING WIRING TESTING CE MARKING DRIVER DIM DALI PUSH 100W	1101D
MONTAGGIO CABLAGGIO COLLAUDO CE DRIVER DIM DALI PUSH 150W MOUNTING WIRING TESTING CE MARKING DRIVER DIM DALI PUSH 150W	1150D
CAVO DI ALIMENTAZIONE 2X0,75 TONDO TRASPARENTE 1CM POWER CABLE 2X0,75 ROUND TRANSPARENT 1CM	98CTT001

“ottica recessa e ottica esterna”

ZER035 x - xp costruito in estruso di alluminio si avvale della tecnologia degli schermi in policarbonato per diffondere la luce per mezzo di LED al top, per qualità, resa cromatica, lumen emessi, ed accurata selezione della temperatura colore, scelta in base al progetto scenografico che vogliamo ottenere. ZER035 x-xp è un sistema di illuminazione LED biemissione pensato per illuminare gli ambienti con una luce diretta sul piano e una luce diffusa. È proposto in due versioni: con ottica recessa (con valore di UGR<19 lungo l'asse trasversale) e con ottica esterna.

ZER035 x-xp built in extruded aluminum uses the technology of polycarbonate screens to diffuse the light by means of top LEDs, for quality, color rendering, lumens emitted, and careful selection of the color temperature, chosen on the basis of the scenographic project which we want to get. ZER035 x - xp is a bi-emission LED lighting system designed to illuminate environments with direct light on the surface and diffused light. It is proposed in two versions: with recessed optic (with UGR value <19 along the transverse axis) and with external optics.



zero65 x

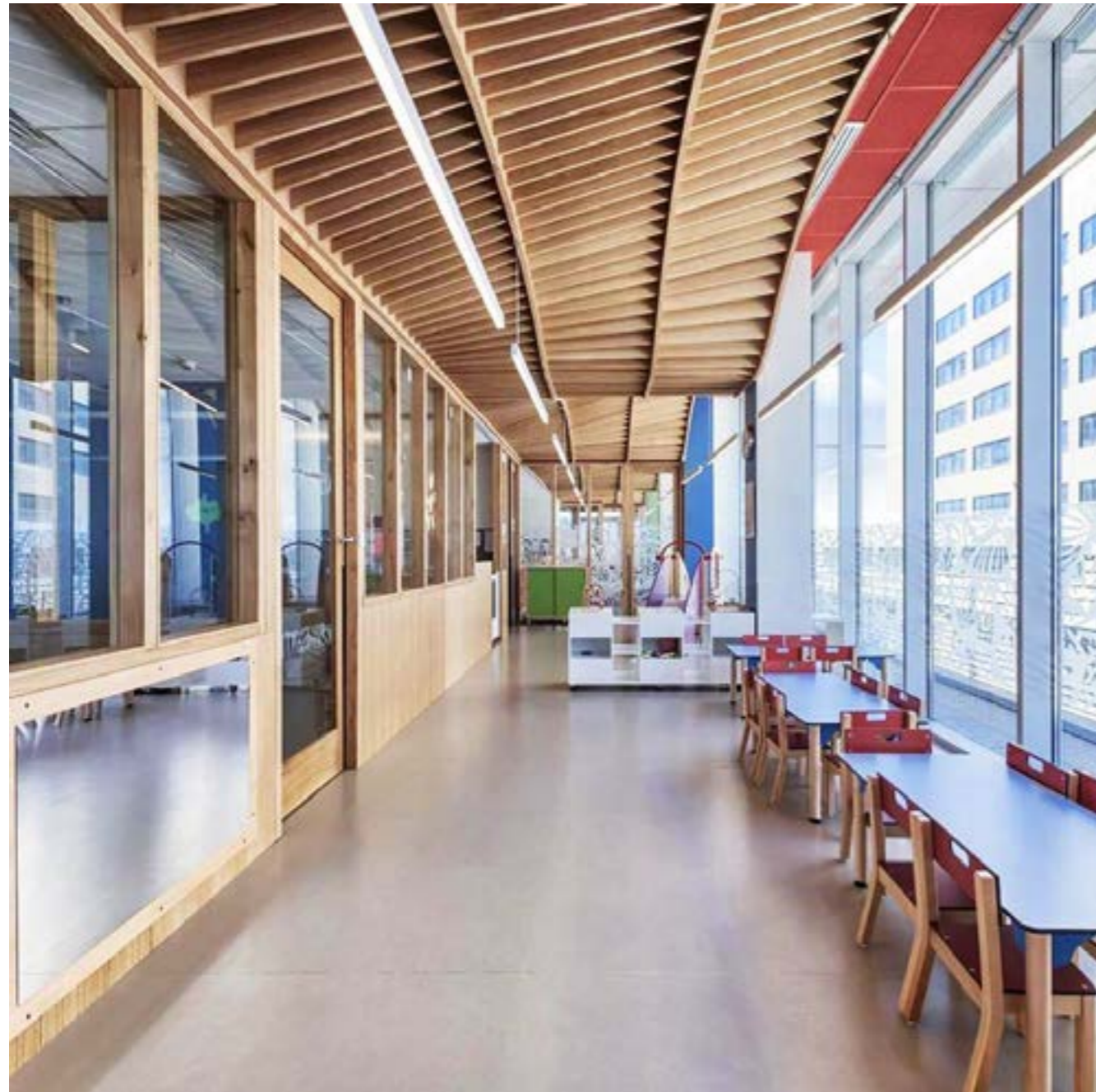

zero65 x

installazione

installation

INSTALLAZIONE A SOSPENSIONE
SUSPENSION

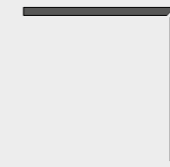
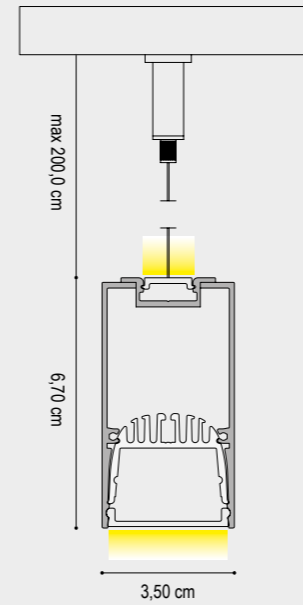

A. COMPOSIZIONE ANGOLARE A "L"
A. L-ANGLE COMPOSITION

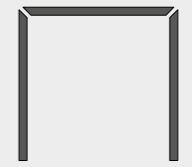

B. COMPOSIZIONE ANGOLARE A "C"
B. C-ANGLE COMPOSITION

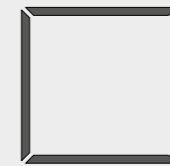

**C. COMPOSIZIONE POLIGONALE
(QUADRATO/RETTANGOLO)**
C. POLYGONAL COMPOSITION
(SQUARE / RECTANGLE)



**D. COMPOSIZIONE POLIGONALE
(PENTAGONO/ESAGONO)**
D. POLYGONAL COMPOSITION
(PENTAGON / HEX)

zero65 x

configurazioni

configurations

INSTALLAZIONE KIT DI SOSPENSIONE
SUSPENSION KIT INSTALLATION

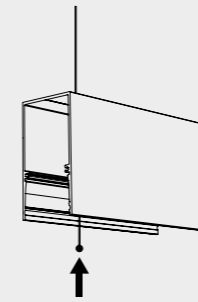

1

1. INSERIRE IL CAVO IN ACCIAIO NEL FORO PRATICATO SULLA PARTE SUPERIORE DEL PROFILO.
1. INSERT THE STEEL CABLE IN THE HOLE DRILLED ON THE TOP OF THE PROFILE.

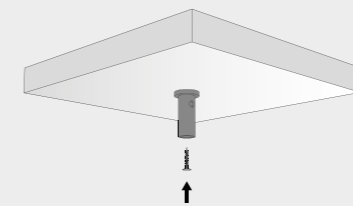

2

2. FISSARE LA BOCCOLA A SOFFITTO PER MEZZO DI TASSELLI IDONEI AL SUPPORTO MURARIO.
2. FIX THE CEILING BUSHING BY MEANS OF SUITABLE DOWELS TO THE WALL SUPPORT.

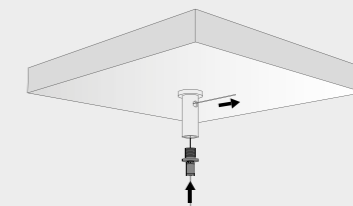

3

3. PREMERE LE DUE ESTREMITÀ DEL PERNO PER INSERIRE IL CAVO IN ACCIAIO FACENDO-LO PASSARE NELLA BOCCOLA A SOFFITTO.
3. PRESS THE TWO PARTS OF THE PIN TO INSERT THE STEEL CABLE AND PASS IT INTO THE CEILING BUSHING.

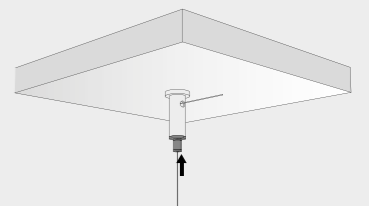

4

4. AVVITARE IL PERNO ALLA BOCCOLA. PREMERE LA PARTE INFERIORE DEL PERNO PER REGOLARE LA LUNGHEZZA DEL CAVO.
4. SCREW THE PIN TO THE BUSH. PRESS THE LOWER PART OF THE PIN TO ADJUST THE CABLE LENGTH.

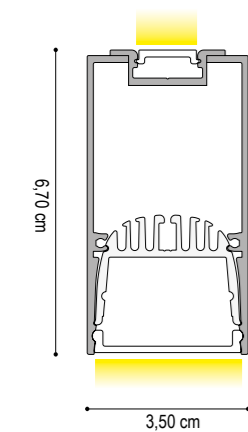

DATI TECNICI
TECHNICAL DATA

	DIFFUSORE ESTERNO / EXTERNAL DIFFUSER		
	1 cm - 40W/m	200 cm - 80W	300 cm - 120W
Nominal LED Flux:	↑ 2200 lm/m - 2200 lm/m ↓	↑ 4400 lm - 4400 lm ↓	↑ 6600 lm - 6600 lm ↓
Flux Tot:	↑ 1890 lm/m - 1680 lm/m ↓	↑ 3780 lm - 3360 lm ↓	↑ 5670 lm - 5040 lm ↓
Output:	110 lm/W	110 lm/W	110 lm/W
CCT:	3000 K	3000 K	3000 K
CRI:	>95	>95	>95
Power:	↑ 20.0W/m - 20.0W/m ↓	↑ 40.0W - 40.0W ↓	↑ 60.0W - 60.0W ↓
Power Tot:	40.0W/m	80.0W	120.0W
Weight:	1.70 Kg/m	3.40 Kg	5.10 Kg

Alluminio/aluminium

Cover: Opale/opal - Satinato/Satin

CAVO ALIMENTAZIONE : 50 cm
ALIMENTATION CABLE : 50 cm

Lmax = 300cm

FINITURA STRUTTURA
FINISHES

- GRIGIO VESUVIO ANTHRACITE
- ARGILLA CLAY
- ARGENTO OPACO MATT SILVER
- BIANCO INTONACO/WHITE
- NERO CARAVAGGIO/BLACK
- MOKA MOCHA
- ORO CALIFORNIA/GOLD
- ARAMEN COPPER
- GRIGIO AVIO/GREY AVIO
- ARGENTO COMETA/SILVER COMET
- OTTONE VENEZIANO/BRASS
- TITANIO/TITANIUM
- BRONZO RIACI/RIACI BRONZE
- VERDE COSTA/GREEN COAST
- TERRA SENESE SENESE EARTH
- CROMO/CHROME

DIFFUSORE
DIFFUSER

- TRASPARENTE
TRASPARENT
- OPALE/OPAL

CODICE CODE	1 cm	200 cm	300 cm
	DRIVER NON INCLUSO NOT INCLUDED	DRIVER ON/OFF INCLUSO INCLUDED	DRIVER ON/OFF INCLUSO INCLUDED
		PREZZO	
1112600011	1112600210		1112600310
1112601011	1112601210		1112601310
1112602011	1112602210		1112602310
1112603011	1112603210		1112603310
1112604011	1112604210		1112604310
1112605011	1112605210		1112605310
1112609011	1112609210		1112609310
1112610011	1112610210		1112610310
1112611011	1112611210		1112611310
1112612011	1112612210		1112612310
1112613011	1112613210		1112613310
1112614011	1112614210		1112614310
1112615011	1112615210		1112615310
1112616011	1112616210		1112616310
1112617011	1112617210		1112617310
1112608011	1112608210		

N.B./P.N.:

LUNGHEZZA MASSIMA VERSIONE CROMO = 2,00 m / MAXIMUM LENGTH CHROME VERSION = 2.00 m
TESTATE DI CHIUSURA NON INCLUSE / DEAD ENDS NOT INCLUDED

DATI TECNICI
TECHNICAL DATA

MONTAGGIO CABLAGGIO COLLAUDO CE DRIVER ON OFF 60W MOUNTING WIRING TESTING CE MARKING DRIVER ON OFF 60W	1050A
MONTAGGIO CABLAGGIO COLLAUDO CE DRIVER ON OFF 96W MOUNTING WIRING TESTING CE MARKING DRIVER ON OFF 96W	1096A
MONTAGGIO CABLAGGIO COLLAUDO CE DRIVER DIM DALI PUSH 60W MOUNTING WIRING TESTING CE MARKING DIM DRIVER DALI PUSH 60W	1060D
MONTAGGIO CABLAGGIO COLLAUDO CE DRIVER DIM DALI PUSH 100W MOUNTING WIRING TESTING CE MARKING DRIVER DIM DALI PUSH 100W	1101D
MONTAGGIO CABLAGGIO COLLAUDO CE DRIVER DIM DALI PUSH 150W MOUNTING WIRING TESTING CE MARKING DRIVER DIM DALI PUSH 150W	1150D

TESTATE DI CHIUSURA / DEAD ENDS

FINITURA STRUTTURA FINISHES	CODICE CODE	FINITURA STRUTTURA FINISHES	CODICE CODE
GRIGIO VESUVIO ANTHRACITE	1110400000	ARAMEN COPPER	1110410000
ARGILLA CLAY	1110401000	GRIGIO AVIO/GREY AVIO	1110411000
ARGENTO OPACO MATT SILVER	1110402000	ARGENTO COMETA/SILVER COMET	1110412000
BIANCO INTONACO/WHITE	1110403000	OTTONE VENEZIANO/BRASS	1110413000
NERO CARAVAGGIO/BLACK	1110404000	TITANIO/TITANIUM	1110414000
MOKA MOCHA	1110405000	BRONZO RIACI/RIACI BRONZE	1110415000
CROMO/CHROME	1110408000	VERDE COSTA/GREEN COAST	1110416000
ORO CALIFORNIA/GOLD	1110409000	TERRA SENESE SENESE EARTH	1110417000

Il codice contiene 1 testata di chiusura con viti.
The code contains 1 closing warhead with screws.

TESTATE DI CHIUSURA CON LOGO / DEAD ENDS WITH LOGO

FINITURA STRUTTURA FINISHES	CODICE CODE	FINITURA STRUTTURA FINISHES	CODICE CODE
GRIGIO VESUVIO ANTHRACITE	1110600000	GRIGIO AVIO/GREY AVIO	1110611000
ARGILLA CLAY	1110601000	ARGENTO COMETA/SILVER COMET	1110612000
BIANCO INTONACO/WHITE	1110603000	OTTONE VENEZIANO/BRASS	1110613000
NERO CARAVAGGIO/BLACK	1110604000	TITANIO/TITANIUM	1110614000
MOKA MOCHA	1110605000	BRONZO RIACI/RIACI BRONZE	1110615000
CROMO/CHROME	1110608000	VERDE COSTA/GREEN COAST	1110616000
ORO CALIFORNIA/GOLD	1110609000	TERRA SENESE SENESE EARTH	1110617000
ARAMEN COPPER	1110610000		

Il codice contiene 1 testata di chiusura.
The code contains 1 closing warhead.

KIT DI SOSPENSIONE / SUSPENSION KIT

ARTICOLI INCLUSI NEL CODICE
ARTICLES INCLUDED IN THE CODE

Cavo in acciaio 2,00m con puntalino
2.00m steel cable with tip
Boccola cromata con regolazione millimetrica
Chrome bush with millimeter adjustment

Cavo in acciaio 3,00m con puntalino
3.00m steel cable with tip

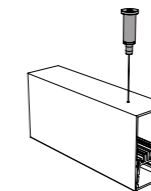

FINITURA FINISHES	CODICE CODE
CROMO/CHROME	1110508200
	1100508200

LAVORAZIONI / PROCESSING

DATI TECNICI
TECHNICAL DATA

TAGLIO 90° ORIZZONTALE (PER ANGOLI FORMATI DA DUE PROFILI) HORIZONTAL 90 ° CUT (FOR CORNERS MADE OF TWO PROFILES)	190X
ASOLA / SLOT	100A
ASOLA CUSTOM / 100n CUSTOM SLOT SLOT	100N
FORO / HOLE	100F
CONNETTORE MASCHIO/FEMMINA MALE/FEMALE CONNECTOR	98CFM
CONNETTORE MASCHIO/FEMMINA MONTATO NEL PRODOTTO MALE/FEMALE CONNECTOR FITTED IN THE PRODUCT	98MFM
CAVO DI ALIMENTAZIONE 2X0,75 TONDO TRASPARENTE 1CM POWER CABLE 2X0,75 ROUND TRANSPARENT 1CM	98CTT001



ZER065X-P CON DIFFUSORE ESTERNO
ZER065X-P WITH EXTERNAL DIFFUSER

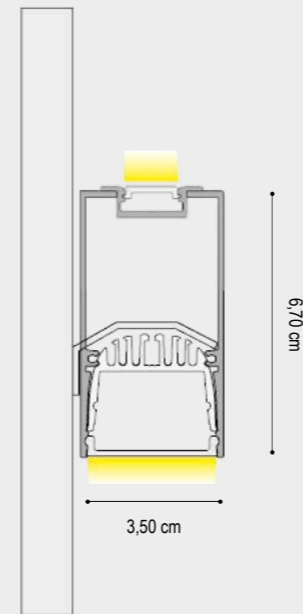

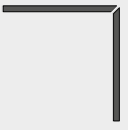
- 

A. COMPOSIZIONE ANGOLARE A "L"
A. L-ANGLE COMPOSITION
- 

B. COMPOSIZIONE ANGOLARE A "C"
B. C-ANGLE COMPOSITION
- 

C. COMPOSIZIONE POLIGONALE (QUADRATO/RETTANGOLO)
C. POLYGONAL COMPOSITION (SQUARE / RECTANGLE)

INSTALLAZIONE STAFFA A PARETE
WALL BRACKET INSTALLATION

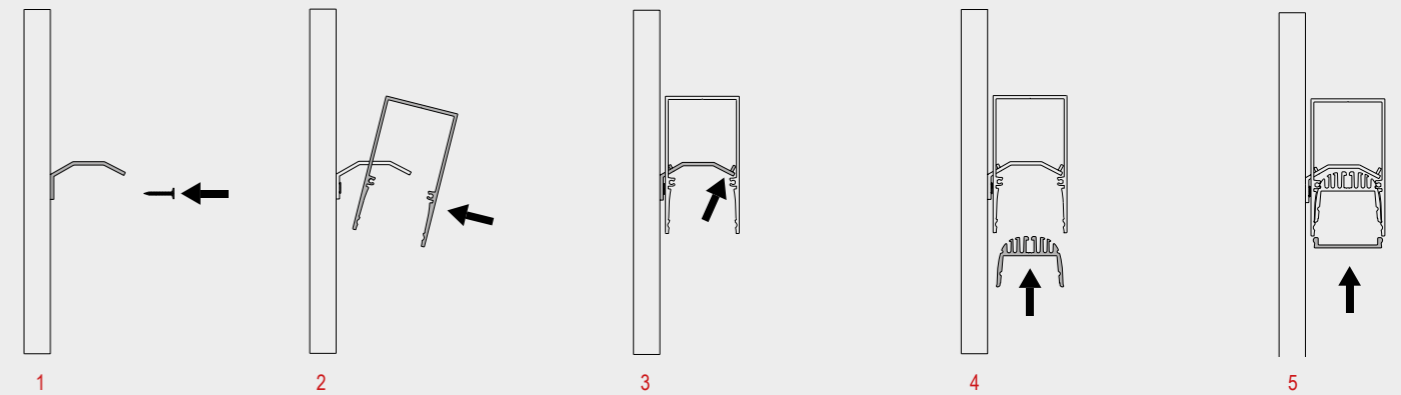

- 1. FISSARE LE STAFFE UTILIZZANDO SISTEMI DI FISSAGGIO IDONEI AL TIPO DI PARETE. PRESTARE ATTENZIONE ALL'ALLINEAMENTO DELLE STAFFE PER UNA CORRETTA INSTALLAZIONE DEL PRODOTTO. IN CASO DI INSTALLAZIONE SU PARETE NON LINEARE, SI CONSIGLIA DI UTILIZZARE SUPPORTI DISTANZIALI AL FINE DI EVITARNE LA TORSIONE.**
1. FIX THE BRACKETS USING FASTENING SYSTEMS SUITABLE FOR THE TYPE OF WALL. PAY ATTENTION TO THE ALIGNMENT OF THE BRACKETS FOR A CORRECT INSTALLATION OF THE PRODUCT. IN THE EVENT OF INSTALLATION ON A NON-LINEAR WALL, IT IS RECOMMENDED TO USE SPACER SUPPORTS IN ORDER TO AVOID TORSION.
- 2. SUL LATO DEL PROFILO RIVOLTO VERSO LA PARETE È PRESENTE UN'ASOLA. INSERIRE LA STAFFA NELL'ASOLA.**
2. THERE IS A SLOT ON THE SIDE OF THE PROFILE FACING THE WALL. INSERT THE BRACKET IN THE SLOT.
- 3. BLOCCARE IL PROFILO ALLA STAFFA UTILIZZANDO GLI APPOSITI GRANI FILETTATI.**
3. LOCK THE PROFILE TO THE BRACKET USING THE SPECIAL THREADED DOWELS.
- 4. INSERIRE IL DISSIPATORE IN ALLUMINIO. ATTENZIONE! ASSICURARSI DEL PERFETTO SCATTO TRA IL DISSIPATORE E IL PROFILO. UN'INSTALLAZIONE ERRATA PUÒ COMPROMETTERE LA TENUTA E LA DURABILITÀ DEL PRODOTTO.**
4. INSERT THE ALUMINUM HEAT SINK. WARNING! MAKE SURE THE PERFECT SNAP BETWEEN THE HEAT SINK AND THE PROFILE. AN INCORRECT INSTALLATION MAY COMPROMISE THE SEALING AND DURABILITY OF THE PRODUCT.
- 5. INSERIRE LA COVER IN POLICARBONATO.**
5. INSERT THE POLYCARBONATE COVER.

zero65 xp

led integrato

integrated led

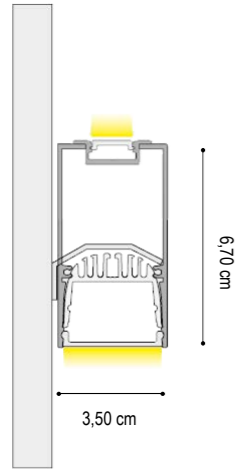

DATI TECNICI
TECHNICAL DATA

	1 cm - 40W/m	200 cm - 80W	300 cm - 120W
Nominal LED Flux:	↑ 2200 lm/m - 2200 lm/m ↓	↑ 4400 lm - 4400 lm ↓	↑ 6600 lm - 6600 lm ↓
Flux Tot:	↑ 1760 lm/m - 1760 lm/m ↓	↑ 3520 lm - 3520 lm ↓	↑ 5280 lm - 5280 lm ↓
Output:	105 lm/W	105 lm/W	105 lm/W
CCT:	3000 K	3000 K	3000 K
CRI:	>95	>95	>95
Power:	↑ 20.0W/m - 20.0W/m ↓	↑ 40.0W - 40.0W ↓	↑ 60.0W - 60.0W ↓
Power Tot:	40.0W/m	80.0W	120.0W
Weight:	1.40 Kg/m	2.80 Kg	4.20 Kg

Alluminio/aluminium

Cover: Opale/opal - Satinato/Satin

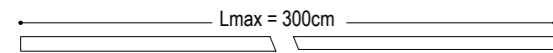

DRIVER NON INCLUSO / NOT INCLUDED

CAVO ALIMENTAZIONE : 50 cm
ALIMENTATION CABLE : 50 cm

FINITURA STRUTTURA
FINISHES

- GRIGIO VESUVIO ANTHRACITE
- ARGILLA CLAY
- ARGENTO OPACO MATT SILVER
- BIANCO INTONACO/WHITE
- NERO CARAVAGGIO BLACK
- MOKA MOCHA
- ORO CALIFORNIA GOLD
- ARAMEN COPPER
- GRIGIO AVIO GREY AVIO
- ARGENTO COMETA/SILVER COMET
- OTTONE VENEZIANO BRASS
- TITANIO/TITANIUM
- BRONZO RIACI/RIACI BRONZE
- VERDE COSTA/GREEN COAST
- TERRA SENESE SENESE EARTH
- CROMO CHROME

DIFFUSORE
DIFFUSER

- OPALE/OPAL
- OPALE/OPAL

	1 cm	200 cm	300 cm
CODICE CODE	1112600061	1112600260	1112600360
CODICE CODE	1112601061	1112601260	1112601360
CODICE CODE	1112602061	1112602260	1112602360
CODICE CODE	1112603061	1112603260	1112603360
CODICE CODE	1112604061	1112604260	1112604360
CODICE CODE	1112605061	1112605260	1112605360
CODICE CODE	1112609061	1112609260	1112609360
CODICE CODE	1112610061	1112610260	1112610360
CODICE CODE	1112611061	1112611260	1112611360
CODICE CODE	1112612061	1112612260	1112612360
CODICE CODE	1112613061	1112613260	1112613360
CODICE CODE	1112614061	1112614260	1112614360
CODICE CODE	1112615061	1112615260	1112615360
CODICE CODE	1112616061	1112616260	1112616360
CODICE CODE	1112617061	1112617260	1112617360
CODICE CODE	1112608061	1112608260	

N.B./P.N.:

LUNGHEZZA MASSIMA VERSIONE CROMO = 2,00 m / MAXIMUM LENGTH CHROME VERSION = 2.00 m

TESTATE NON INCLUSE / DEAD ENDS NOT INCLUDED

IL DISSIPATORE INTERNO VIENE FORNITO DI SERIE IN FINITURA ALLUMINIO NATURALE / THE EXTERNAL HEATSINK IS SUPPLIED AS STANDARD IN A NATURAL ALUMINIUM FINISH

zero65 xp

led integrato

integrated led

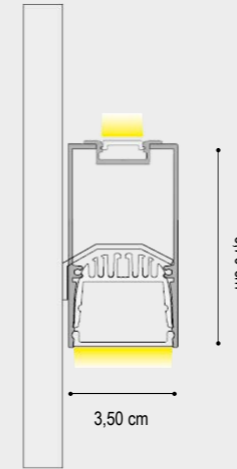

DATI TECNICI
TECHNICAL DATA

	1 cm - 40W/m	200 cm - 80W	300 cm - 120W
Nominal LED Flux:	↑ 4050 lm/m - 4050 lm/m ↓	↑ 8100 lm - 8100 lm ↓	↑ 12150 lm - 12150 lm ↓
Flux Tot:	↑ 3510 lm/m - 3510 lm/m ↓	↑ 7020 lm - 7020 lm ↓	↑ 10530 lm - 10530 lm ↓
Output:	135 lm/W	135 lm/W	135 lm/W
CCT:	3000 K	3000 K	3000 K
CRI:	>95	>95	>95
Power:	↑ 30.0W/m - 30.0W/m ↓	↑ 60.0W - 60.0W ↓	↑ 90.0W - 90.0W ↓
Power Tot:	60.0W/m	120.0W	180.0W
Weight:	1.40 Kg/m	2.80 Kg	4.20 Kg

Alluminio/aluminium

Cover: Opale/opal - Satinato/Satin

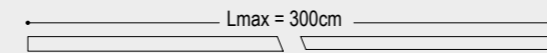

DRIVER NON INCLUSO / NOT INCLUDED

CAVO ALIMENTAZIONE : 50 cm
ALIMENTATION CABLE : 50 cm

FINITURA STRUTTURA
FINISHES

- GRIGIO VESUVIO ANTHRACITE
- ARGILLA CLAY
- ARGENTO OPACO MATT SILVER
- BIANCO INTONACO/WHITE
- NERO CARAVAGGIO BLACK
- MOKA MOCHA
- ORO CALIFORNIA GOLD
- ARAMEN COPPER
- GRIGIO AVIO GREY AVIO
- ARGENTO COMETA/SILVER COMET
- OTTONE VENEZIANO BRASS
- TITANIO/TITANIUM
- BRONZO RIACI/RIACI BRONZE
- VERDE COSTA/GREEN COAST
- TERRA SENESE SENESE EARTH
- CROMO CHROME

DIFFUSORE
DIFFUSER

- OPALE/OPAL
- OPALE/OPAL

	1 cm	200 cm	300 cm
CODICE CODE	1118100061	1118100260	1118100360
CODICE CODE	1118101061	1118101260	1118101360
CODICE CODE	1118102061	1118102260	1118102360
CODICE CODE	1118103061	1118103260	1118103360
CODICE CODE	1118104061	1118104260	1118104360
CODICE CODE	1118105061	1118105260	1118105360
CODICE CODE	1118109061	1118109260	1118109360
CODICE CODE	1118110061	1118110260	1118110360
CODICE CODE	1118111061	1118111260	1118111360
CODICE CODE	1118112061	1118112260	1118112360
CODICE CODE	1118113061	1118113260	1118113360
CODICE CODE	1118114061	1118114260	1118114360
CODICE CODE	1118115061	1118115260	1118115360
CODICE CODE	1118116061	1118116260	1118116360
CODICE CODE	1118117061	1118117260	1118117360
CODICE CODE	1118108061	1118108260	

N.B./P.N.:

LUNGHEZZA MASSIMA VERSIONE CROMO = 2,00 m / MAXIMUM LENGTH CHROME VERSION = 2.00 m

TESTATE NON INCLUSE / DEAD ENDS NOT INCLUDED

IL DISSIPATORE INTERNO VIENE FORNITO DI SERIE IN FINITURA ALLUMINIO NATURALE / THE EXTERNAL HEATSINK IS SUPPLIED AS STANDARD IN A NATURAL ALUMINIUM FINISH

zero65 xp

led integrato

integrated led

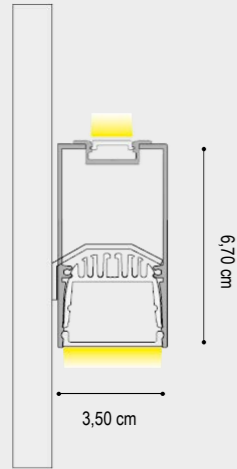

DATI TECNICI
TECHNICAL DATA

	1 cm - 40W/m	200 cm - 80W	300 cm - 120W
Nominal LED Flux:	↑ 2200 lm/m - 2200 lm/m ↓	↑ 4400 lm - 4400 lm ↓	↑ 6600 lm - 6600 lm ↓
Flux Tot:	↑ 1760 lm/m - 1760 lm/m ↓	↑ 3520 lm - 3520 lm ↓	↑ 5280 lm - 5280 lm ↓
Output:	105 lm/W	105 lm/W	105 lm/W
CCT:	3000 K	3000 K	3000 K
CRI:	>95	>95	>95
Power:	↑ 20.0W/m - 20.0W/m ↓	↑ 40.0W - 40.0W ↓	↑ 60.0W - 60.0W ↓
Power Tot:	40.0W/m	80.0W	120.0W
Weight:	1.40 Kg/m	2.80 Kg	4.20 Kg

Alluminio/aluminium

Cover: Satinato/Satin
Prismatizzato/Prismatic

Lmax = 300cm

DRIVER NON INCLUSO / NOT INCLUDED

CAVO ALIMENTAZIONE : 50 cm
ALIMENTATION CABLE : 50 cm

1 cm

200 cm

300 cm

DRIVER NON INCLUSO
NOT INCLUDED

DRIVER ON/OFF INCLUSO
INCLUDED

DRIVER ON/OFF INCLUSO
INCLUDED

FINITURA STRUTTURA
FINISHES

- GRIGIO VESUVIO ANTHRACITE
- ARGILLA CLAY
- ARGENTO OPACO MATT SILVER
- BIANCO INTONACO/WHITE
- NERO CARAVAGGIO BLACK
- MOKA MOCHA
- ORO CALIFORNIA GOLD
- ARAMEN COPPER
- GRIGIO AVIO GREY AVIO
- ARGENTO COMETA/SILVER COMET
- OTTONE VENEZIANO BRASS
- TITANIO/TITANIUM
- BRONZO RIACI/RIACI BRONZE
- VERDE COSTA/GREEN COAST
- TERRA SENESE SENESE EARTH
- CROMO CHROME

DIFFUSORE
DIFFUSER

- SATINATA/SATIN
- PRISMATIZZATO
PRISMATIC

CODICE
CODE

- 1112600051
- 1112601051
- 1112602051
- 1112603051
- 1112604051
- 1112605051
- 1112609051
- 1112610051
- 1112611051
- 1112612051
- 1112613051
- 1112614051
- 1112615051
- 1112616051
- 1112617051
- 1112608051

CODICE
CODE

- 1112600250
- 1112601250
- 1112602250
- 1112603250
- 1112604250
- 1112605250
- 1112609250
- 1112610250
- 1112611250
- 1112612250
- 1112613250
- 1112614250
- 1112615250
- 1112616250
- 1112617250
- 1112608250

CODICE
CODE

- 1112600350
- 1112601350
- 1112602350
- 1112603350
- 1112604350
- 1112605350
- 1112609350
- 1112610350
- 1112611350
- 1112612350
- 1112613350
- 1112614350
- 1112615350
- 1112616350
- 1112617350

N.B./P.N.:

LUNGHEZZA MASSIMA VERSIONE CROMO = 2,00 m / MAXIMUM LENGTH CHROME VERSION = 2.00 m

TESTATE NON INCLUSE / DEAD ENDS NOT INCLUDED

IL DISSIPATORE INTERNO VIENE FORNITO DI SERIE IN FINITURA ALLUMINIO NATURALE / THE EXTERNAL HEATSINK IS SUPPLIED AS STANDARD IN A NATURAL ALUMINIUM FINISH

zero65 xp

led integrato

integrated led

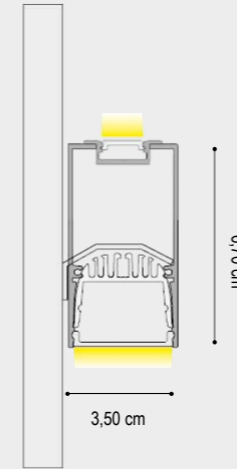

DATI TECNICI
TECHNICAL DATA

	1 cm - 40W/m	200 cm - 80W	300 cm - 120W
Nominal LED Flux:	↑ 4440 lm/m - 4440 lm/m ↓	↑ 8880 lm - 8880 lm ↓	↑ 13320 lm - 13320 lm ↓
Flux Tot:	↑ 3552 lm/m - 3552 lm/m ↓	↑ 7104 lm - 7104 lm ↓	↑ 10656 lm - 10656 lm ↓
Output:	148 lm/W	148 lm/W	148 lm/W
CCT:	3000 K	3000 K	3000 K
CRI:	>90	>90	>90
Power:	↑ 30.0W/m - 30.0W/m ↓	↑ 60.0W - 60.0W ↓	↑ 90.0W - 90.0W ↓
Power Tot:	60.0W/m	120.0W	180.0W
Weight:	1.40 Kg/m	2.80 Kg	4.20 Kg

Alluminio/aluminium

Cover: Satinato/Satin
Prismatizzato/Prismatic

Lmax = 300cm

DRIVER NON INCLUSO / NOT INCLUDED

CAVO ALIMENTAZIONE : 50 cm
ALIMENTATION CABLE : 50 cm

1 cm

200 cm

300 cm

DRIVER NON INCLUSO
NOT INCLUDED

DRIVER ON/OFF INCLUSO
INCLUDED

DRIVER ON/OFF INCLUSO
INCLUDED

FINITURA STRUTTURA
FINISHES

- GRIGIO VESUVIO ANTHRACITE
- ARGILLA CLAY
- ARGENTO OPACO MATT SILVER
- BIANCO INTONACO/WHITE
- NERO CARAVAGGIO BLACK
- MOKA MOCHA
- ORO CALIFORNIA GOLD
- ARAMEN COPPER
- GRIGIO AVIO GREY AVIO
- ARGENTO COMETA/SILVER COMET
- OTTONE VENEZIANO BRASS
- TITANIO/TITANIUM
- BRONZO RIACI/RIACI BRONZE
- VERDE COSTA/GREEN COAST
- TERRA SENESE SENESE EARTH
- CROMO CHROME

DIFFUSORE
DIFFUSER

- SATINATA/SATIN
- PRISMATIZZATO
PRISMATIC

CODICE
CODE

- 1118100051
- 1118101051
- 1118102051
- 1118103051
- 1118104051
- 1118105051
- 1118109051
- 1118110051
- 1118111051
- 1118112051
- 1118113051
- 1118114051
- 1118115051
- 1118116051
- 1118117051
- 1118108051

CODICE
CODE

- 1118100250
- 1118101250
- 1118102250
- 1118103250
- 1118104250
- 1118105250
- 1118109250
- 1118110250
- 1118111250
- 1118112250
- 1118113250
- 1118114250
- 1118115250
- 1118116250
- 1118117250
- 1118108250

CODICE
CODE

- 1118100350
- 1118101350
- 1118102350
- 1118103350
- 1118104350
- 1118105350
- 1118109350
- 1118110350
- 1118111350
- 1118112350
- 1118113350
- 1118114350
- 1118115350
- 1118116350
- 1118117350

N.B./P.N.:

LUNGHEZZA MASSIMA VERSIONE CROMO = 2,00 m / MAXIMUM LENGTH CHROME VERSION = 2.00 m

TESTATE NON INCLUSE / DEAD ENDS NOT INCLUDED

IL DISSIPATORE INTERNO VIENE FORNITO DI SERIE IN FINITURA ALLUMINIO NATURALE / THE EXTERNAL HEATSINK IS SUPPLIED AS STANDARD IN A NATURAL ALUMINIUM FINISH



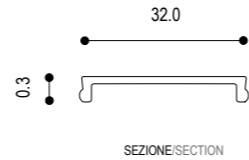
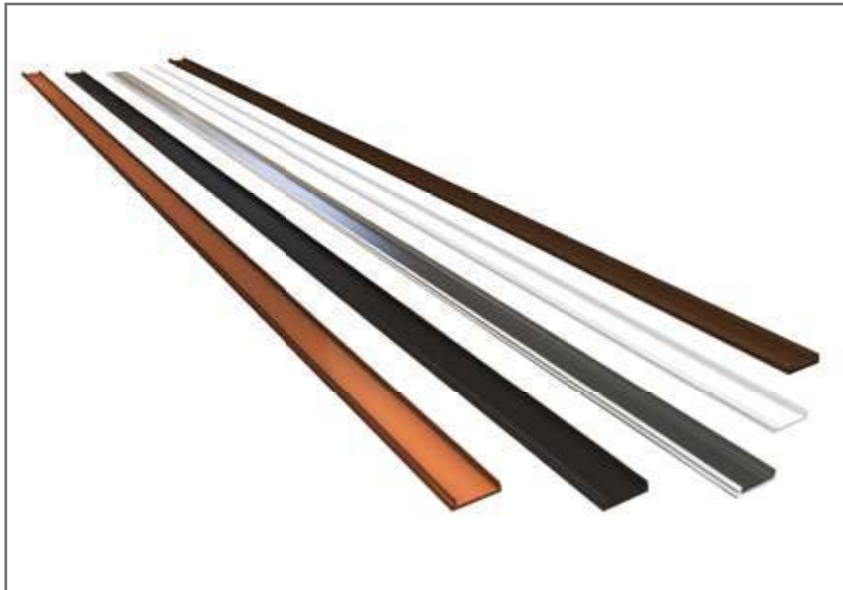

1 cm

1 cm

FINITURA STRUTTURA FINISHES	CODICE CODE
GRIGIO VESUVIO ANTHRACITE	1100500001
ARGILLA CLAY	1100501001
ARGENTO OPACO MATT SILVER	1100502001
BIANCO INTONACO/WHITE	1100503001
NERO CARAVAGGIO BLACK	1100504001
MOKA MOCHA	1100505001
CROMO CHROME	1100508001
ORO CALIFORNIA/GOLD	1100509001

FINITURA STRUTTURA FINISHES	CODICE CODE
ARAMEN COPPER	1100510001
ARGENTO COMETA/SILVER COMET	1100511001
GRIGIO AVIO GREY AVIO	1100512001
OTTONE VENEZIANO BRASS	1100513001
TITANIO/TITANIUM	1100514001
BRONZO RIACI/RIACI BRONZE	1100515001
VERDE COSTA/GREEN COAST	1100516001
TERRA SENESE SENESE EARTH	1100517001

TESTATE DI CHIUSURA CON LOGO / DEAD ENDS WITH LOGO

FINITURA STRUTTURA FINISHES	CODICE CODE	FINITURA STRUTTURA FINISHES	CODICE CODE
GRIGIO VESUVIO ANTHRACITE	1110600000	GRIGIO AVIO GREY AVIO	1110611000
ARGILLA CLAY	1110601000	ARGENTO COMETA/SILVER COMET	1110612000
BIANCO INTONACO/WHITE	1110603000	OTTONE VENEZIANO BRASS	1110613000
NERO CARAVAGGIO BLACK	1110604000	TITANIO/TITANIUM	1110614000
MOKA MOCHA	1110605000	BRONZO RIACI/RIACI BRONZE	1110615000
CROMO CHROME	1110608000	VERDE COSTA/GREEN COAST	1110616000
ORO CALIFORNIA/GOLD	1110609000	TERRA SENESE SENESE EARTH	1110617000
ARAMEN COPPER	1110610000		

Il codice contiene 1 testata di chiusura.
The code contains 1 closing warhead.

TESTATE DI CHIUSURA / DEAD ENDS

FINITURA STRUTTURA FINISHES	CODICE CODE	FINITURA STRUTTURA FINISHES	CODICE CODE
GRIGIO VESUVIO ANTHRACITE	1110400000	ARAMEN COPPER	1110410000
ARGILLA CLAY	1110401000	GRIGIO AVIO GREY AVIO	1110411000
ARGENTO OPACO MATT SILVER	1110402000	ARGENTO COMETA/SILVER COMET	1110412000
BIANCO INTONACO/WHITE	1110403000	OTTONE VENEZIANO BRASS	1110413000
NERO CARAVAGGIO BLACK	1110404000	TITANIO/TITANIUM	1110414000
MOKA MOCHA	1110405000	BRONZO RIACI/RIACI BRONZE	1110415000
CROMO CHROME	1110408000	VERDE COSTA/GREEN COAST	1110416000
ORO CALIFORNIA/GOLD	1110409000	TERRA SENESE SENESE EARTH	1110417000

GIUNTI / JOINTS

GIUNTO LINEA CONTINUA / STRAIGHT JOINT

Accessorio per giunzioni meccaniche lineari
Accessory for linear mechanical joints

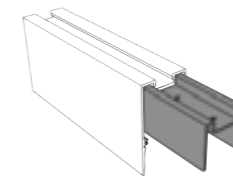

FINITURA FINISHES	CODICE CODE
ALLUMINIO NATURALE/ALUMINUM	1110506003

GIUNTO 90° ORIZZONTALE / HORIZONTAL JOINT 90°

Accessorio per giunzioni meccaniche con angolo 90°
Accessory for linear mechanical joints with 90° angle

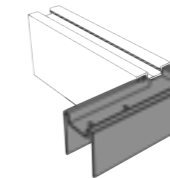

ALLUMINIO NATURALE/ALUMINUM	1110506004
-----------------------------	------------

LAVORAZIONI / PROCESSING

DATI TECNICI/TECHNICAL DATA

	CODICE CODE
TAGLIO 90° ORIZZONTALE (PER ANGOLI FORMATI DA DUE PROFILI) HORIZONTAL 90° CUT (FOR CORNERS MADE OF TWO PROFILES)	190X
TAGLIO ANGOLARE CUSTOM (PER ANGOLI FORMATI DA DUE PROFILI) CUSTOM CORNER CUT (FOR CORNERS MADE OF TWO PROFILES)	190N
ASOLA CUSTOMIZZATA / CUSTOM SLOT	100N
CABLAGGIO - COLLAUDO - CE AL CENTIMETRO INSTALLATION AND TESTING LED MODULE AT CENTIMETER	1111
CONNETTORE MASCHIO/FEMMINA MALE/FEMALE CONNECTOR	98CFM
CONNETTORE MASCHIO/FEMMINA MONTATO NEL PRODOTTO MALE/ FEMALE CONNECTOR FITTED IN THE PRODUCT	98MFM
MONTAGGIO CABLAGGIO COLLAUDO CE DRIVER ON OFF 60W MOUNTING WIRING TESTING CE MARKING DRIVER ON OFF 60W	1050A
MONTAGGIO CABLAGGIO COLLAUDO CE DRIVER ON OFF 96W MOUNTING WIRING TESTING CE MARKING DRIVER ON OFF 96W	1096A
MONTAGGIO CABLAGGIO COLLAUDO CE DRIVER DIM DALI PUSH 60W MOUNTING WIRING TESTING CE MARKING DIM DRIVER DALI PUSH 60W	1060D
MONTAGGIO CABLAGGIO COLLAUDO CE DRIVER DIM DALI PUSH 100W MOUNTING WIRING TESTING CE MARKING DRIVER DIM DALI PUSH 100W	1101D
MONTAGGIO CABLAGGIO COLLAUDO CE DRIVER DIM DALI PUSH 150W MOUNTING WIRING TESTING CE MARKING DRIVER DIM DALI PUSH 150W	1150D
CAVO DI ALIMENTAZIONE 2X0,75 TONDO TRASPARENTE 1CM POWER CABLE 2X0,75 ROUND TRANSPARENT 1CM	98CTT001

“moduli customizzabili”

ZER065 SPOT ADVANCE è un prodotto composto da moduli customizzabili che consentono di avere sul medesimo sistema lineare diverse sorgenti luminose. A seconda delle necessità si può richiedere l'installazione di moduli SPOT abbinati a moduli LED. Lo ZER065 SPOT ADVANCE è un prodotto multi installazione: sospensione e soffitto. È particolarmente adatto per illuminare spazi espositivi.

ZER065 SPOT ADVANCE is a product composed of customizable modules that allow you to have different light sources on the same linear system. Depending on your needs, you can request the installation of SPOT modules combined with LED modules. The ZER065 SPOT ADVANCE is a multi-installation product: suspension and ceiling. It is particularly suitable for illuminating exhibition spaces.



zero65 spot advanced

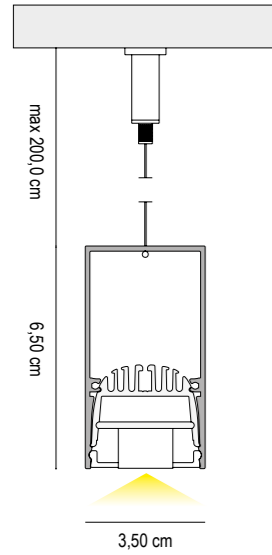

DATI TECNICI
TECHNICAL DATA

	120 cm (15+90+15)cm	150 cm (15+120+15)cm	180 cm (15+150+15)cm
Nominal LED Flux:	1980 lm	2640 lm	3300 lm
Nominal SPOT Flux:	1524 lm	1524 lm	1524 lm
Flux Tot:	2803 lm	3331 lm	3860 lm
Output:	105 lm/W + 121 lm/W	105 lm/W + 121 lm/W	105 lm/W + 121 lm/W
CCT:	3000 K	3000 K	3000 K
CRI:	>95	>95	>95
LED Power Tot:	18.0W	24.0W	30.0W
SPOT Power Tot:	18.0W (3W x 6)	18.0W (3W x 6)	18.0W (3W x 6)
Weight:	2.04 Kg	2.55 Kg	3.06 Kg
	Alluminio/aluminium		Cover: Opale/opal

ARTICOLI INCLUSI NEL CODICE / ITEMS INCLUDED IN THE CODE:
DRIVER ON/OFF
COPPIA DI TESTATE DI CHIUSURA / PAIR OF CLOSING HEADS
KIT DI SOSPENSIONE / SUSPENSION KIT

zero65 spot advanced

installazione

installation

INSTALLAZIONE KIT DI SOSPENSIONE
SUSPENSION KIT INSTALLATION

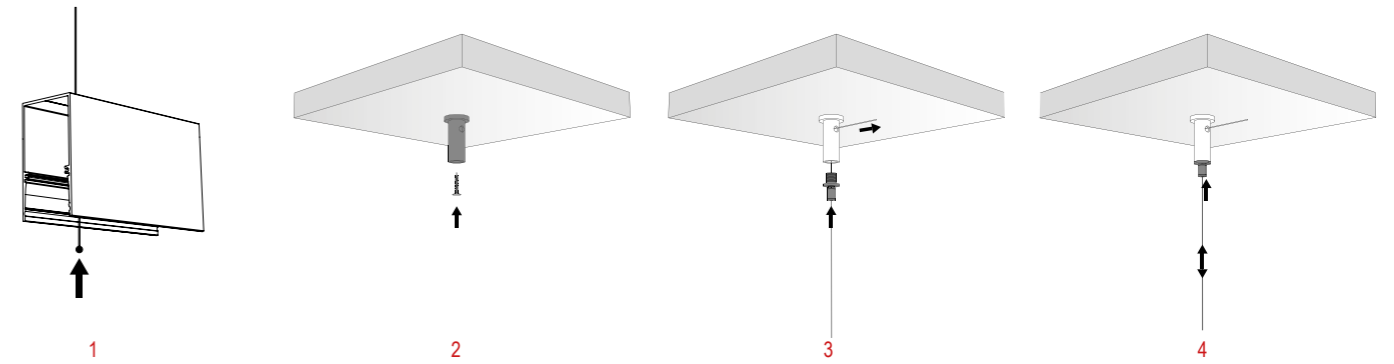

1. INSERIRE IL CAVO IN ACCIAIO NEL FORO PRATICATO SULLA PARTE SUPERIORE DEL PROFILO.
1. INSERT THE STEEL CABLE IN THE HOLE DRILLED ON THE TOP OF THE PROFILE.
2. FISSARE LA BOCCOLA A SOFFITTO PER MEZZO DI TASSELLI IDONEI AL SUPPORTO MURARIO.
2. FIX THE CEILING BUSHING BY MEANS OF SUITABLE DOWELS TO THE WALL SUPPORT.
3. PREMERE LE DUE ESTREMITÀ DEL PERNO PER INSERIRE IL CAVO IN ACCIAIO FACENDO-LO PASSARE NELLA BOCCOLA A SOFFITTO.
3. PRESS THE TWO PARTS OF THE PIN TO INSERT THE STEEL CABLE AND PASS IT INTO THE CEILING BUSHING.
4. AVVITARE IL PERNO ALLA BOCCOLA. PREMERE LA PARTE INFERIORE DEL PERNO PER REGOLARE LA LUNGHEZZA DEL CAVO.
4. SCREW THE PIN TO THE BUSH. PRESS THE LOWER PART OF THE PIN TO ADJUST THE CABLE LENGTH.

FINITURA STRUTTURA
FINISHES

GRIGIO VESUVIO ANTHRACITE
ARGILLA CLAY
BIANCO INTONACO/WHITE
NERO CARAVAGGIO BLACK
MOKA MOCHA
CROMO/CHROME
ORO CALIFORNIA/GOLD
ARAMEN COPPER
ARGENTO COMETA/SILVER COMET
OTTONE VENEZIANO VENETIAN BRASS
TITANIO/TITANIUM
BRONZO RIACI/RIACI BRONZE
VERDE COSTA/GREEN COAST
TERRA SENESE SENESE EARTH
NERO-CROMO BLACK-CHROME

DIFFUSORE
DIFFUSER

OPALE/OPAL

	120 cm (15+90+15)cm	150 cm (15+120+15)cm	180 cm (15+150+15)cm
CODICE CODE	1118400120	1118400150	1118400180
	1118401120	1118401150	1118401180
	1118403120	1118403150	1118403180
	1118404120	1118404150	1118404180
	1118405120	1118405150	1118405180
	1118408120	1118408150	1118408180
	1118409120	1118409150	1118409180
	1118410120	1118410150	1118410180
	1118412120	1118412150	1118412180
	1118413120	1118413150	1118413180
	1118414120	1118414150	1118414180
	1118415120	1118415150	1118415180
	1118416120	1118416150	1118416180
	1118417120	1118417150	1118417180
	1118448120	1118448150	1118448180

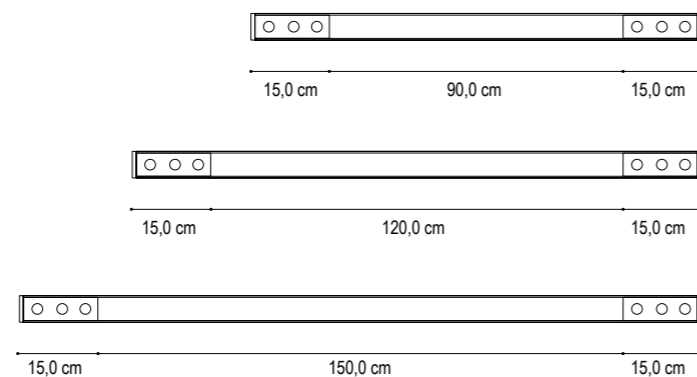

“eleganza e tagli di luce”

ZERO66 costruito in estruso di alluminio si avvale della tecnologia degli schermi in policarbonato per diffondere la luce per mezzo di LED al top, per qualità, resa cromatica, lumen emessi, ed accurata selezione della temperatura colore, scelta in base al progetto scenografico che vogliamo ottenere. ZERO66 è la versione della famiglia ZERO per l'installazione a cartongesso. È caratterizzato dai due bordi laterali in alluminio che aiutano nell'installazione e regalano eleganza al taglio di luce.

ZERO66 made of extruded aluminum uses the technology of polycarbonate screens to diffuse the light by means of top LEDs, for quality, color rendering, lumens emitted, and careful selection of the color temperature, chosen on the basis of the scenographic project which we want to get. ZERO66 is the version of the ZERO family for plasterboard installation. It is characterized by two aluminum side edges that help in the installation and give elegance to the cut of light.

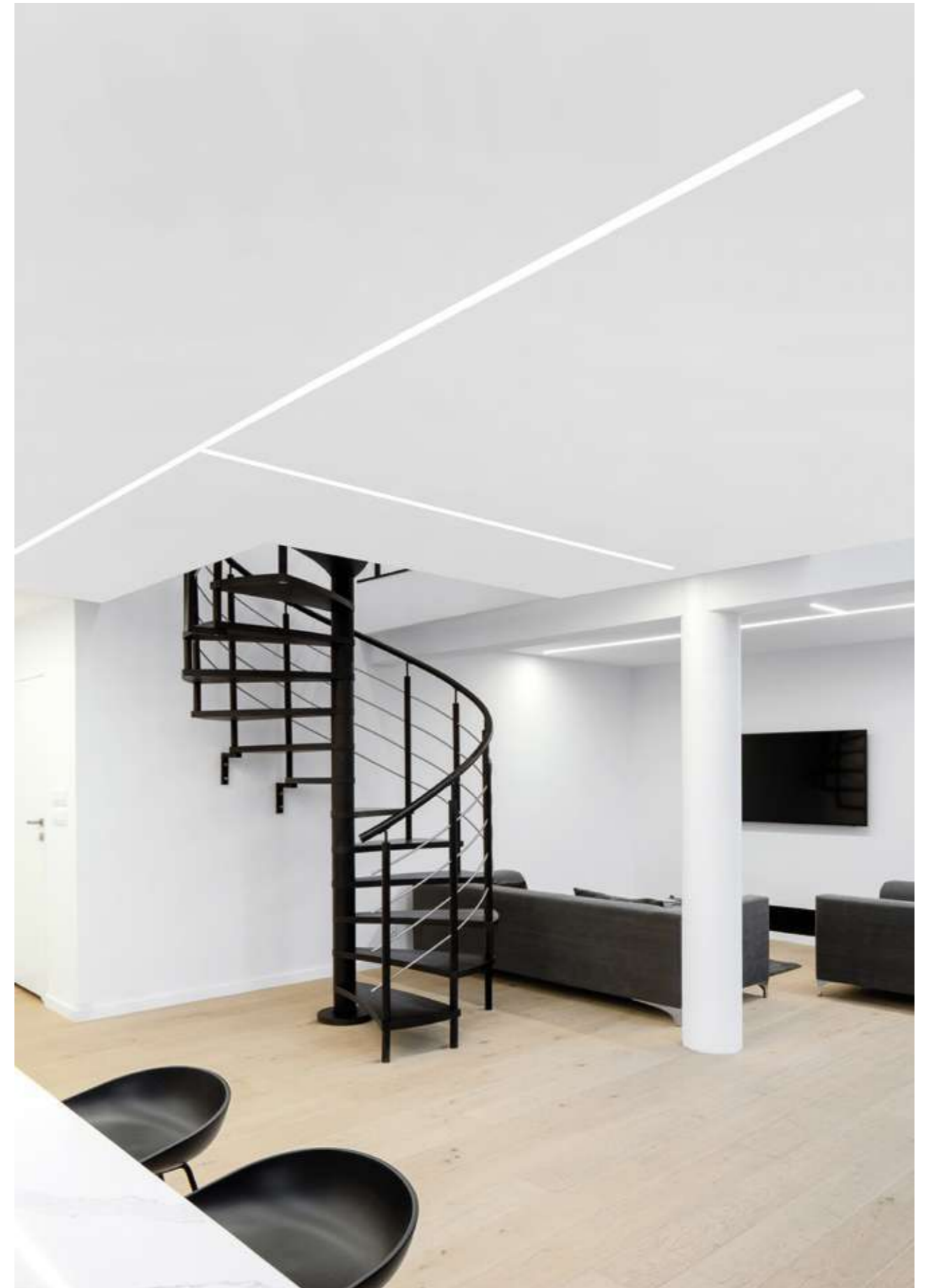

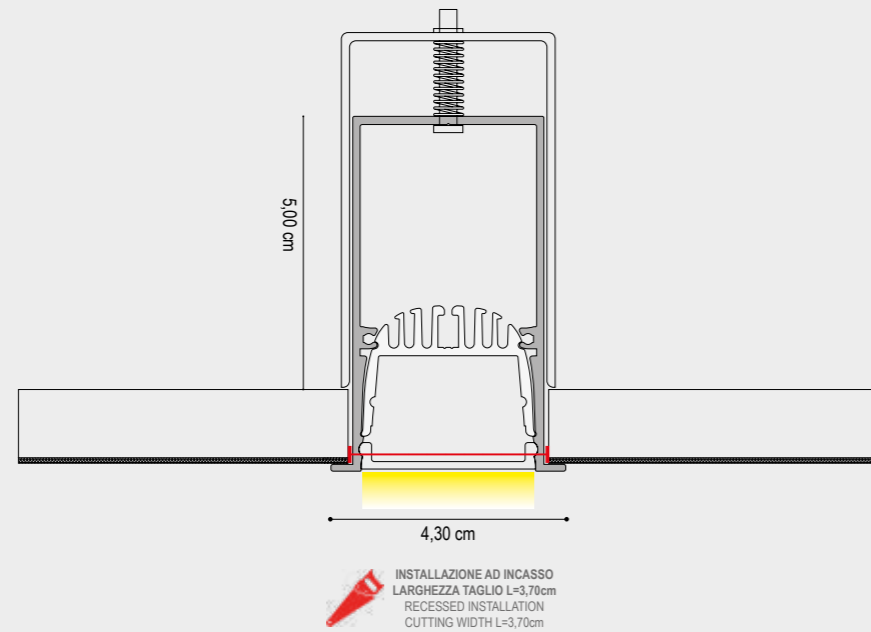

ATTENZIONE! GLI ACCESSORI PER L'INSTALLAZIONE A INCASSO SONO STATI DIMENSIONATI PER UN PANNELLO STANDARD IN CARTONGESSO DI SPESSORE 12,5 mm
WARNING! THE BUILT-IN INSTALLATION ACCESSORIES HAVE BEEN DIMENSIONED FOR A STANDARD PLASTERBOARD PANEL OF 12.5 mm THICKNESS

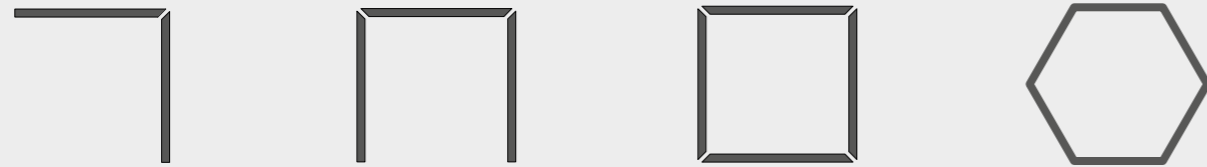

- A. COMPOSIZIONE ANGOLARE A "L"
A. L-ANGLE COMPOSITION
- B. COMPOSIZIONE ANGOLARE A "C"
B. C-ANGLE COMPOSITION
- C. COMPOSIZIONE POLIGONALE (QUADRATO/RETTANGOLO)
C. POLYGONAL COMPOSITION (SQUARE / RECTANGLE)
- D. COMPOSIZIONE POLIGONALE (PENTAGONO/ESAGONO)
D. POLYGONAL COMPOSITION (PENTAGON / HEX)

PER LE COMPOSIZIONI POLIGONALI RIVOLGERSI AL NOSTRO REPARTO TECNICO.
FOR POLYGONAL COMPOSITIONS, PLEASE CONTACT OUR TECHNICAL DEPARTMENT.

DRIVER NON INCLUSO/NOT INCLUDED

CAVO ALIMENTAZIONE : 50 cm
ALIMENTATION CABLE : 50 cm

DATI TECNICI
TECHNICAL DATA



	1 cm	1 cm	1 cm
Nominal LED Flux:	2880 lm/m	3000 lm/m	3120 lm/m
Flux Tot:	2360 lm/m	2460 lm/m	2490 lm/m
Output:	120 lm/W	125 lm/W	130 lm/W
CCT:	2700 K	3000 K	4000 K
CRI:	>95	>95	>95
Power Tot:	24.0 W/m	24.0 W/m	24.0 W/m
Weight:	0.90 Kg/m	0.90 Kg/m	0.90 Kg/m

Alluminio/aluminium

Lmax = 300cm

FINITURA STRUTTURA
FINISHES

- ARGILLA CLAY
- BIANCO INTONACO/WHITE
- NERO CARAVAGGIO/BLACK
- TERRA SENESE SENESE EARTH

DIFFUSORE
DIFFUSER

- OPALE/OPAL

	1 cm - 2700K	1 cm - 3000K	1 cm - 4000K
CODICE CODE	112H601001	112H701001	112H801001
CODICE CODE	112H603001	112H703001	112H803001
CODICE CODE	112H604001	112H704001	112H804001
CODICE CODE	112H617001	112H717001	112H817001

N.B./P.N.:

LUNGHEZZA MASSIMA VERSIONE CROMO = 2,00 m / MAXIMUM LENGTH CHROME VERSION = 2.00 m
TESTATE DI CHIUSURA NON INCLUSE / DEAD ENDS NOT INCLUDED

DRIVER INCLUSO/NOT INCLUDED

CAVO ALIMENTAZIONE : 50 cm
ALIMENTATION CABLE : 50 cm

DATI TECNICI
TECHNICAL DATA



	1 cm	200 cm	300 cm
Nominal LED Flux:	4050 lm/m	8100 lm	12150 lm
Flux Tot:	3240 lm/m	6480 lm	9720 lm
Output:	135 lm/W	135 lm/W	135 lm/W
CCT:	3000 K	3000 K	3000 K
CRI:	>90	>90	>90
Power Tot:	30.0 W/m	60.0 W	90.0 W
Weight:	0.90 Kg/m	1.80 Kg	2.70 Kg

Alluminio/aluminium

Cover: Opale/opal

Lmax = 300cm

FINITURA STRUTTURA
FINISHES

- ARGILLA CLAY
- BIANCO INTONACO/WHITE
- NERO CARAVAGGIO/BLACK
- TERRA SENESE SENESE EARTH

DIFFUSORE
DIFFUSER

- OPALE/OPAL

	1 cm	200 cm	300 cm
CODICE CODE	1128101001	1128101200	1128101300
CODICE CODE	1128103001	1128103200	1128103300
CODICE CODE	1128104001	1128104200	1128104300
CODICE CODE	1128117001	1128117200	1128117300

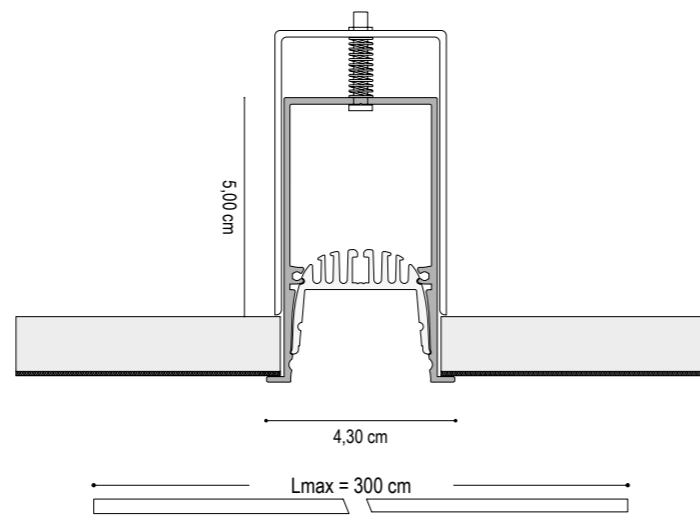
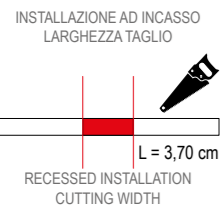
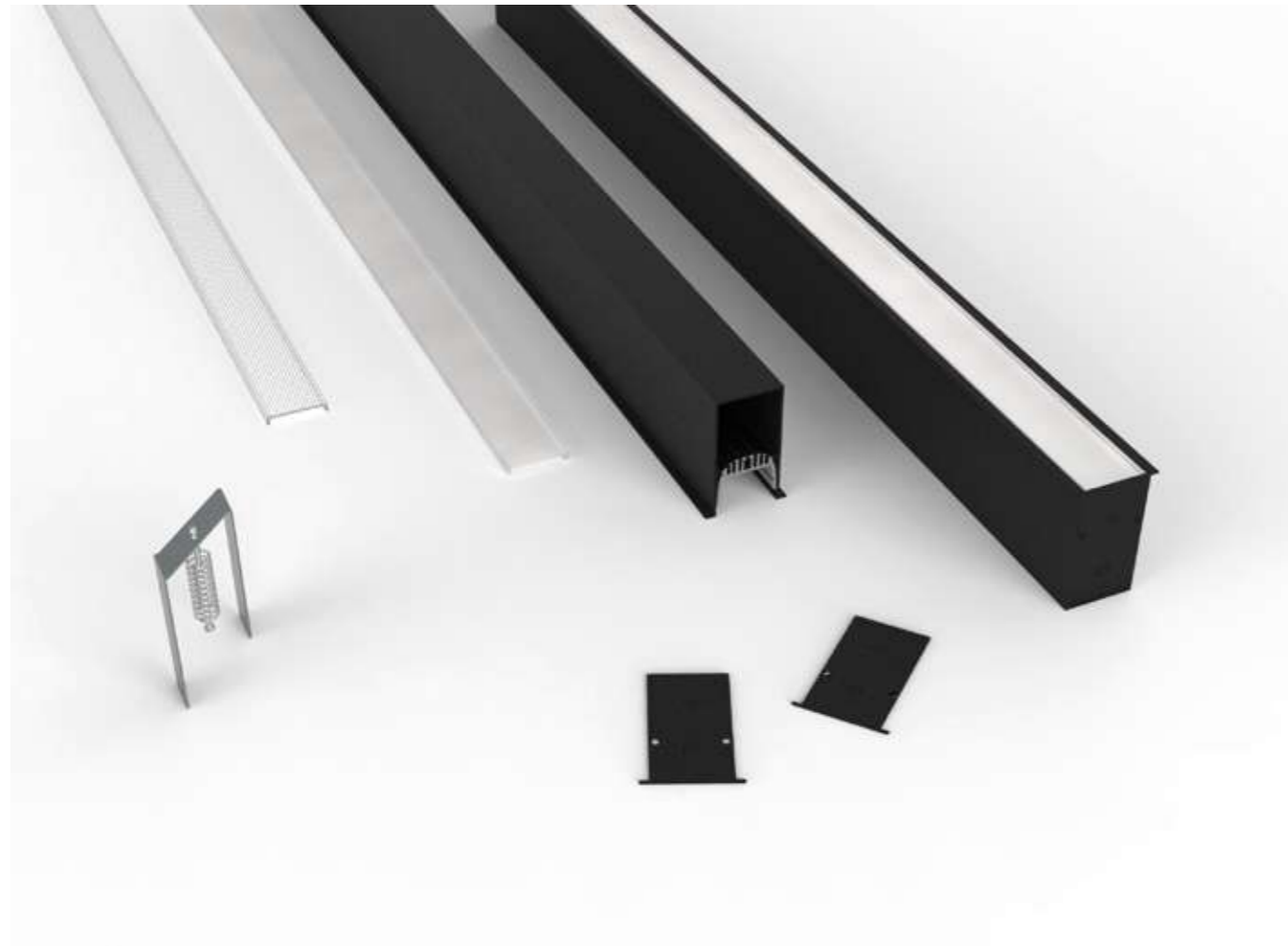

LED compatibili / LED compatibility

HIGH QUALITY CRI>90 CRI>95	HIGH OUTPUT CRI>90 CRI>95	HIGH EFFICIENT CRI>90 CRI>95	HIGH INTENSITY CRI>90 CRI>95	LOW POWER CRI>90	ULTRA SLIM CRI>90 CRI>95 CRI>97	RGB	RGB WHITE	RGB TW	TUNABLE WHITE
9,6W 14,4W 19,2W	12,3W 14,4W 19,2W 20W 24W	12,3W 14,4W 19,2W 20W 24W	24W 24W (700 LED)	6W	9,6W 12W 14,4W	14W	14W	14,4W 23W	19,2W

FINITURA STRUTTURA
FINISHES

- ARGILLA CLAY
- BIANCO INTONACO/WHITE
- NERO CARAVAGGIO/BLACK
- TERRA SENESE SENESE EARTH

	1 cm	200 cm	300 cm
CODICE CODE	CODICE CODE	CODICE CODE	CODICE CODE
1120301001	1120301200	1120301300	1120301300
1120303001	1120303200	1120303300	1120303300
1120304001	1120304200	1120304300	1120304300
1120317001	1120317200	1120317300	1120317300

N.B./P.N.:

LUNGHEZZA MASSIMA VERSIONE CROMO = 2,00 m / MAXIMUM LENGTH CHROME VERSION = 2.00 m

DIFFUSORE

	1 cm	200 cm	300 cm	400 cm
DIFFUSORE DIFFUSER	CODICE CODE	CODICE CODE	CODICE CODE	CODICE CODE
OPALE/OPAL	1100100001	1100100200	1100100300	1100100400
SATINATA/SATIN	1100101001	1100101200	1100101300	1100101400
PRISMATIZZATO	1100103001	1100103200	1100103300	1100103400
ECLISSI / ECLIPSE	1100106001	1100106200	1100106300	1100106400

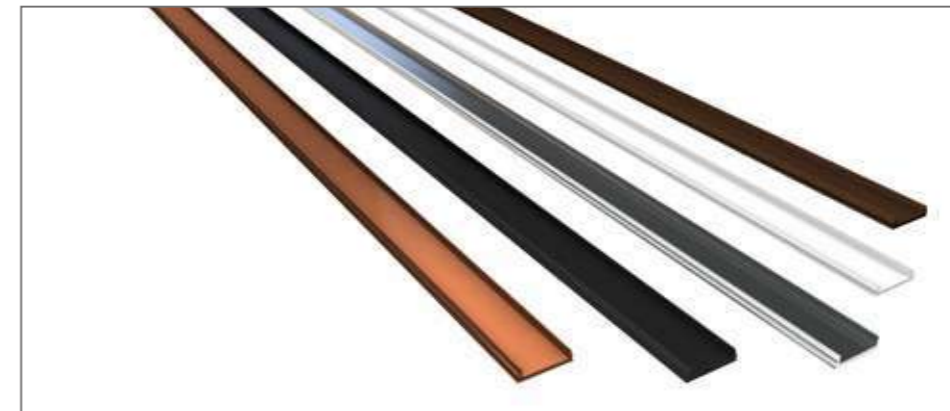

COVER ALLUMINIO / ALUMINUM COVER

FINITURA STRUTTURA
FINISHES

- ARGILLA CLAY
- BIANCO INTONACO/WHITE
- NERO CARAVAGGIO/BLACK
- TERRA SENESE SENESE EARTH

	1 cm
CODICE CODE	CODICE CODE
1100501001	1100501001
1100503001	1100503001
1100504001	1100504001
1100517001	1100517001



TESTATE DI CHIUSURA / DEAD ENDS

	FINITURA STRUTTURA FINISHES	CODICE CODE		FINITURA STRUTTURA FINISHES	CODICE CODE
	ARGILLA CLAY	1120401000		NERO CARAVAGGIO BLACK	1120404000
	BIANCO INTONACO/WHITE	1120403000		TERRA SENESE /SENESE EARTH	1120417000

Il codice contiene 1 testata di chiusura con viti.
The code contains 1 closing warhead with screws.



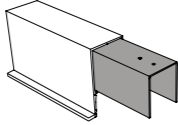
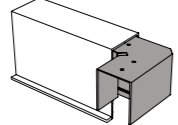
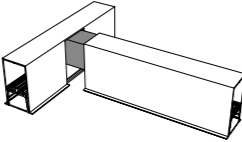
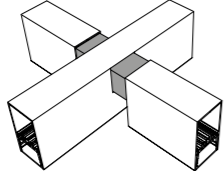







GIUNTI / JOINTS

		FINITURA FINISHES	CODICE CODE
GIUNTO LINEA CONTINUA / STRAIGHT JOINT Accessorio per giunzioni meccaniche lineari Accessory for linear mechanical joints		ALLUMINIO NATURALE ALUMINUM	1110506001
GIUNTO 90° ORIZZONTALE / HORIZONTAL JOINT 90° Accessorio per giunzioni meccaniche con angolo 90° Accessory for linear mechanical joints with 90° angle		ALLUMINIO NATURALE ALUMINUM	1110506002
GIUNTO ANGOLARE A T / ANGULAR T-JOINT Accessorio per giunzioni meccaniche a T Accessory for mechanical T-junctions		ALLUMINIO NATURALE ALUMINUM	1120506003
GIUNTO ANGOLARE A X / ANGULAR X-JOINT Accessorio per giunzioni meccaniche a X Accessory for mechanical X-junctions		ALLUMINIO NATURALE ALUMINUM	1120506004

STAFFA DI FISSAGGIO A CARTONGESSO / MOUNTING CLIP FOR PLASTERBOARD

	FINITURA FINISHES	CODICE CODE
Accessorio che consente l'incasso del modello. Accessory that allows the collection of the model. Nel codice sono comprese le viti per il fissaggio del modello alla staffa. The code includes screws for fixing ther model to the bracket.	ALLUMINIO NATURALE/ALUMINUM	1120501

LAVORAZIONI / PROCESSING

DATI TECNICI TECHNICAL DATA	CODICE CODE
 TAGLIO 90° ORIZZONTALE (PER ANGOLI FORMATI DA DUE PROFILI) HORIZONTAL 90 ° CUT (FOR CORNERS MADE OF TWO PROFILES)	190X
 TAGLIO ANGOLARE CUSTOM (PER ANGOLI FORMATI DA DUE PROFILI) CUSTOM CORNER CUT (FOR CORNERS MADE OF TWO PROFILES)	190N
 ASOLA CUSTUM / SLOT CUSTOM	100N
 FORO / HOLE	100F
 CABLAGGIO - COLLAUDO - CE AL CENTIMETRO INSTALLATION AND TESTING LED MODULE AT CENTIMETER	1111
 CONNETTORE MASCHIO/FEMMINA MALE/FEMALE CONNECTOR	98CFM
 CONNETTORE MASCHIO/FEMMINA MONTATO NEL PRODOTTO MALE/ FEMALE CONNECTOR FITTED IN THE PRODUCT	98MFM
 DRIVER INTEGRATO ON OFF 60W MOUNTING WIRING TESTING CE MARKING DRIVER ON OFF 60W	1050A
 DRIVER INTEGRATO ON OFF 96W MOUNTING WIRING TESTING CE MARKING DRIVER ON OFF 96W DRIVER	1096A
 INTEGRATO DIM DALI PUSH 60W MOUNTING WIRING TESTING CE MARKING DIM DRIVER DALI PUSH 60W	1060D
 DRIVER INTEGRATO DIM DALI PUSH 100W MOUNTING WIRING TESTING CE MARKING DRIVER DIM DALI PUSH 100W	1101D



“il benessere della luce naturale”

Q10 La luce naturale incentiva la comunicazione il benessere e regola i ritmi biologici della vita. È la nostra risposta nella ricerca continua di creare una luce che trasmetta sensazioni stimolanti, aiuti nell'orientamento ed esprima qualità, soprattutto quando le architetture raggiungono altissimi livelli qualitativi e prestazionali. Q10 contribuisce a tutto questo grazie alle sue lenti e alla tecnologia led appositamente progettata per garantire la possibilità di studiare e personalizzare ogni tipo di progetto commerciale, museale.

Q10 Natural light stimulates communication, well-being and regulates the biological rhythms of life. It is our response in the continuous search to create a light that transmits stimulating sensations, helps in orientation and expresses quality, especially when the architectures reach the highest quality and performance levels. Q10 contributes to all this thanks to its lenses and LED technology specially designed to guarantee the possibility of studying and customizing any type of commercial, museum project.

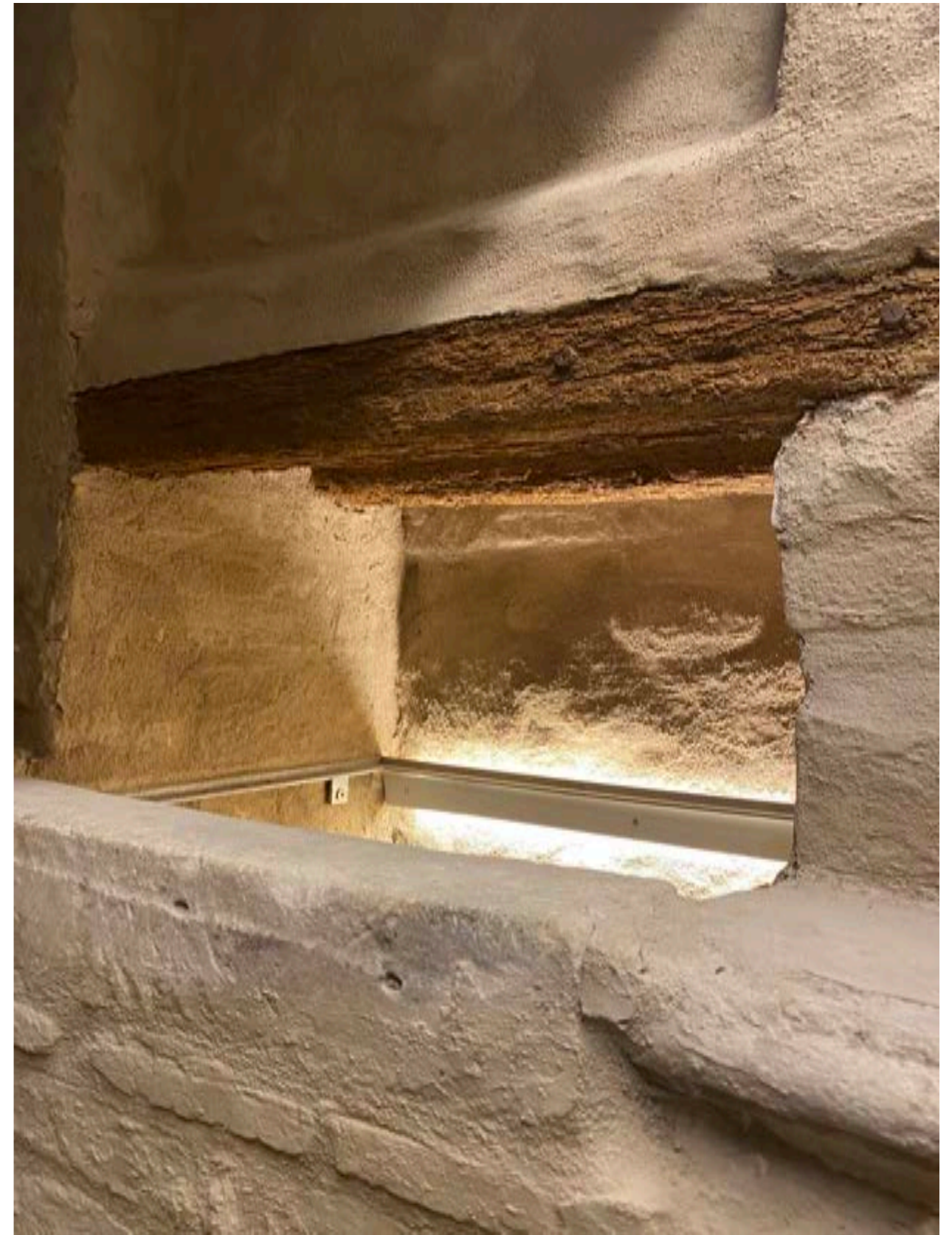

q10

configurazioni

configurations

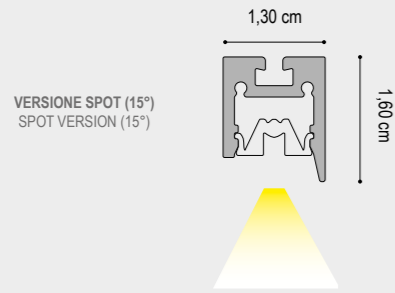

VERSIONE SPOT (15°)
SPOT VERSION (15°)

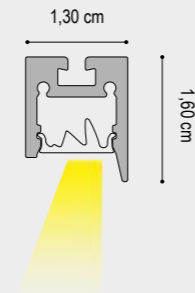

VERSIONE WALL WASHER (45°)
WALL WASHER VERSION (45°)

LE CONFIGURAZIONI RIPORTATE SONO COMPATIBILI PER LA VERSIONE SPOT E PER LA VERSIONE WALL WASHER.
THE CONFIGURATIONS SHOWN ARE COMPATIBLE FOR THE SPOT VERSION AND FOR THE WALL WASHER VERSION.

INSTALLAZIONE A SOSPENSIONE
SUSPENSION

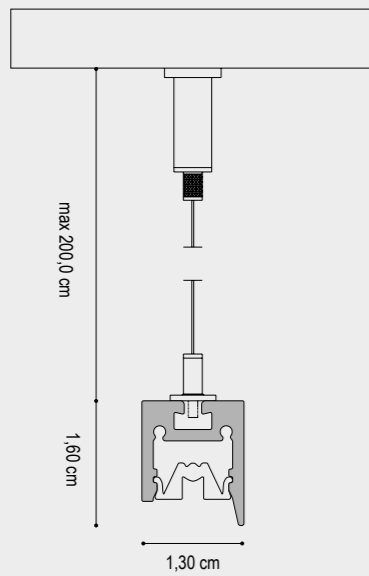

INSTALLAZIONE CON CLIP IN POLICARBONATO SU SUPERFICIE ORIZZONTALE
INSTALLATION WITH POLYCARBONATE CLIP ON HORIZONTAL SURFACE

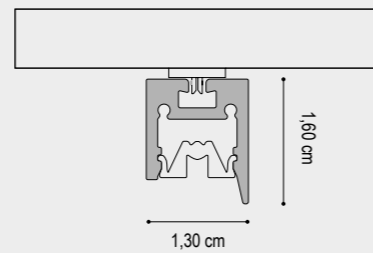

INSTALLAZIONE CON STAFFE MAGNETICHE SU SUPERFICIE METALLICA ORIZZONTALE
INSTALLATION WITH MAGNET ON HORIZONTAL METAL SURFACE

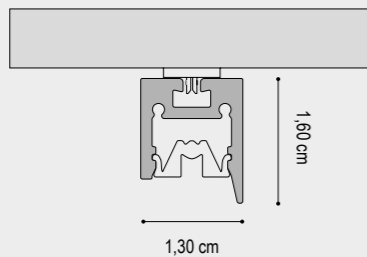

SI RACCOMANDA L'UTILIZZO DI N° 1 STAFFA MAGNETICA OGNI 25,00 cm DI PROFILO. TALE QUANTITÀ PUÒ VARIARE A SECONDA DELLA SUPERFICIE METALLICA DI INSTALLAZIONE.

WE RECOMMEND THE USE OF N° 1 MAGNETIC BRACKET EVERY 25.00 cm OF PROFILE. THIS QUANTITY MAY VARY DEPENDING ON THE METAL INSTALLATION SURFACE.

q10

profilo e diffusore

profiled and diffuser

DATI TECNICI
TECHNICAL DATA

	1 cm	1 cm
Nominal LED Flux:	1800 lm/m	1900 lm/m
Flux Tot:	1600 lm/m	1700 lm/m
Output:	150 lm/W	158 lm/W
CCT:	2700 K	3000 K
CRI:	>90	>90
Power Tot:	12.0W/m	12.0W/m
Weight:	0.30 Kg/m	0.30 Kg/m

Alluminio/aluminium Lente/Lens: 15°

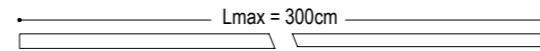

DRIVER NON INCLUSO / NOT INCLUDED

CAVO ALIMENTAZIONE : 50 cm
ALIMENTATION CABLE : 50 cm

FINITURA STRUTTURA
FINISHES

- GRIGIO VESUVIO ANTHRACITE
- ARGILLA CLAY
- ARGENTO OPACO MATT SILVER
- BIANCO INTONACO/WHITE
- NERO CARAVAGGIO BLACK
- MOKA MOCHA
- CROMO CHROME
- ORO CALIFORNIA/GOLD
- ARAMEN COPPER
- ARGENTO COMETA/SILVER COMET
- OTTONE VENEZIANO/VENETIAN BRASS
- TITANIO/TITANIUM
- BRONZO RIACI/RIACI BRONZE
- VERDE COSTA/GREEN COAST
- TERRA SENESE SENESE EARTH

DIFFUSORE
DIFFUSER

LENTE 15° / LENS 15°

1 cm - 2700K

1 cm - 3000K

CODICE CODE	CODICE CODE
195400S001	195500S001
195401S001	195501S001
195402S001	195502S001
195403S001	195503S001
195404S001	195504S001
195405S001	195505S001
195408S001	195508S001
195409S001	195509S001
195410S001	195510S001
195412S001	195512S001
195413S001	195513S001
195414S001	195514S001
195415S001	195515S001
195416S001	195516S001
195417S001	195517S001

N.B./P.N.: LUNGHEZZA MASSIMA VERSIONE CROMO = 2,00 m / MAXIMUM LENGTH CHROME VERSION = 2.00 m
TESTATE DI CHIUSURA NON INCLUSE / DEAD ENDS NOT INCLUDED

DIAGRAMMA FOTOMETRICO
LENTE SPOT - 15°

PHOTOMETRIC DIAGRAM
SPOT LENS - 15°

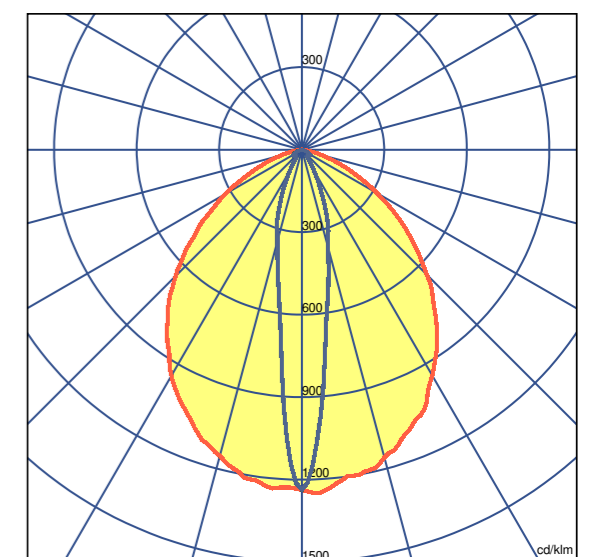

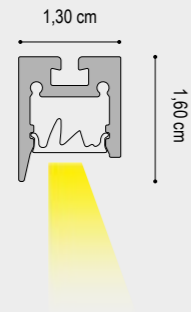

DATI TECNICI
TECHNICAL DATA

	1 cm	1 cm
Nominal LED Flux:	1800 lm/m	1900 lm/m
Flux Tot:	1600 lm/m	1700 lm/m
Output:	150 lm/W	158 lm/W
CCT:	2700 K	3000 K
CRI:	>90	>90
Power Tot:	12.0W/m	12.0W/m
Weight:	0.30 Kg/m	0.30 Kg/m

Alluminio/aluminium Lente/Lens: 15°

DRIVER NON INCLUSO / NOT INCLUDED

CAVO ALIMENTAZIONE : 50 cm
ALIMENTATION CABLE : 50 cm

Lmax = 300cm

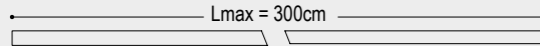

FINITURA STRUTTURA
FINISHES

- GRIGIO VESUVIO ANTHRACITE
- ARGILLA CLAY
- ARGENTO OPACO MATT SILVER
- BIANCO INTONACO/WHITE
- NERO CARAVAGGIO BLACK
- MOKA MOCHA
- CROMO/CHROME
- ORO CALIFORNIA/GOLD
- ARAMEN COPPER
- ARGENTO COMETA/SILVER COMET
- OTTONE VENEZIANO/VENETIAN BRASS
- TITANIO/TITANIUM
- BRONZO RIACI/RIACI BRONZE
- VERDE COSTA/GREEN COAST
- TERRA SENESE SENESE EARTH

DIFFUSORE
DIFFUSER

▲ LENTE 45° / LENS 45°

1 cm - 2700K 1 cm - 3000K

CODICE CODE	CODICE CODE
195400W001	195500W001
195401W001	195501W001
195402W001	195502W001
195403W001	195503W001
195404W001	195504W001
195405W001	195505W001
195408W001	195508W001
195409W001	195509W001
195410W001	195510W001
195412W001	195512W001
195413W001	195513W001
195414W001	195514W001
195415W001	195515W001
195416W001	195516W001
195417W001	195517W001

N.B./P.N.: LUNGHEZZA MASSIMA VERSIONE CROMO = 2,00 m / MAXIMUM LENGTH CHROME VERSION = 2.00 m
TESTATE DI CHIUSURA NON INCLUSE / DEAD ENDS NOT INCLUDED

DIAGRAMMA FOTOMETRICO
LENTE WALL WASHER - 45°

PHOTOMETRIC DIAGRAM
WALL WASHER LENS - 45°

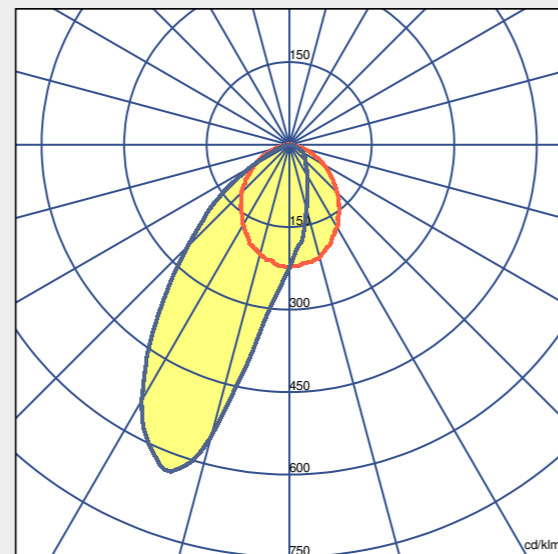

TESTATE DI CHIUSURA / DEAD ENDS



FINITURA STRUTTURA
FINISHES

- GRIGIO VESUVIO ANTHRACITE
- ARGILLA CLAY
- ARGENTO OPACO MATT SILVER
- BIANCO INTONACO/WHITE
- NERO CARAVAGGIO BLACK
- MOKA MOCHA
- CROMO/CHROME
- ORO CALIFORNIA/GOLD

CODICE CODE

- 190400
- 190401
- 190402
- 190403
- 190404
- 190405
- 190408
- 190409

FINITURA STRUTTURA
FINISHES

- ARAMEN COPPER
- GRIGIO AVIO GREY AVIO
- ARGENTO COMETA/SILVER COMET
- OTTONE VENEZIANO BRASS
- TITANIO/TITANIUM
- BRONZO RIACI/RIACI BRONZE
- VERDE COSTA/GREEN COAST
- TERRA SENESE SENESE EARTH

CODICE CODE

- 190410
- 190411
- 190412
- 190413
- 190414
- 190415
- 190416
- 190417

Il codice contiene 1 testata di chiusura con viti.
The code contains 1 closing warhead with screws.

STAFFA DI FISSAGGIO A DOPPIO ATTACCO / DOUBLE MOUNTING CLIP CALAMITA / MAGNET



FINITURA FINISHES

- SUPERFICI PIANE 2mm
EVEN SURFACE 2mm
- SUPERFICI IRREGOLARI 3,9mm
UNEVEN SURFACE 3,9mm

CODICE CODE

- 1020500005
- 1020500006



CODICE CODE

- 1020500010
- 1020500210

PORTATA RANGE

- 1 Kg
- 2 Kg

Accessorio per fissaggio a plafone/superficie. Quantità raccomandata: 1 pz ogni 50 cm di modello.

Ceiling/surface mounting accessory. Recommended quantity 1 pc every 50 cm of model.

Quantità raccomandata: 1 pz ogni 25 cm di modello.

Recommended quantity: 1 pc every 25 cm of model.

KIT DI SOSPENSIONE / SUSPENSION KIT

DATI TECNICI
TECHNICAL DATA

ARTICOLI INCLUSI NEL CODICE
ARTICLES INCLUDED IN THE CODE

Cavo in acciaio 2,00m con puntalino
2.00m steel cable with tip
Boccola cromata con regolazione millimetrica
Chrome bush with millimeter adjustment
Archetto in alluminio per sospensione
Aluminum arch for suspension

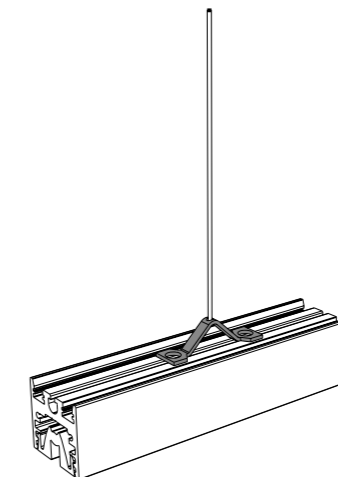

FINITURA STRUTTURA
FINISHES

- GRIGIO VESUVIO ANTHRACITE
- ARGILLA CLAY
- ARGENTO OPACO MATT SILVER
- BIANCO INTONACO/WHITE
- NERO CARAVAGGIO BLACK
- MOKA MOCHA
- CROMO/CHROME
- ORO CALIFORNIA/GOLD
- ARAMEN COPPER
- GRIGIO AVIO GREY AVIO
- ARGENTO COMETA/SILVER COMET
- OTTONE VENEZIANO BRASS
- TITANIO/TITANIUM
- BRONZO RIACI/RIACI BRONZE
- VERDE COSTA/GREEN COAST
- TERRA SENESE SENESE EARTH

CODICE CODE



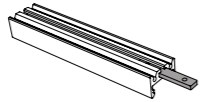
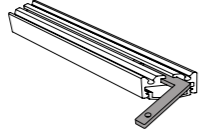

- 1040500004
- 1040501004
- 1040502004
- 1040503004
- 1040504004
- 1040505004
- 1040508004
- 1040509004
- 1040510004
- 1040511004
- 1040512004
- 1040513004
- 1040514004
- 1040515004
- 1040516004
- 1040517004

GIUNTI / JOINTS

		FINITURA FINISHES	CODICE CODE
GIUNTO LINEA CONTINUA / STRAIGHT JOINT Accessorio per giunzioni meccaniche lineari Accessory for linear mechanical joints		ALLUMINIO NATURALE / ALUMINUM	1010500006
GIUNTO 90° ORIZZONTALE / HORIZONTAL JOINT 90° Accessorio per giunzioni meccaniche con angolo 90° Accessory for linear mechanical joints with 90° angle		ALLUMINIO NATURALE / ALUMINUM	1010500005

Il codice contiene i grani per il fissaggio del giunto.
The code contains the grains to fix the joint.

LAVORAZIONI / PROCESSING

	DATI TECNICI TECHNICAL DATA	CODICE CODE
	TAGLIO 90° ORIZZONTALE (PER ANGOLI FORMATI DA DUE PROFILI) HORIZONTAL 90 ° CUT (FOR CORNERS MADE OF TWO PROFILES)	190X
	TAGLIO ANGOLARE CUSTOM (PER ANGOLI FORMATI DA DUE PROFILI) CUSTOM CORNER CUT (FOR CORNERS MADE OF TWO PROFILES)	190N
	ASOLA / SLOT	100A
	FORO / HOLE	100F
	CAVO DI ALIMENTAZIONE 2X0,75 TONDO TRASPARENTE 1CM POWER CABLE 2X0,75 ROUND TRANSPARENT 1CM	98CTT001

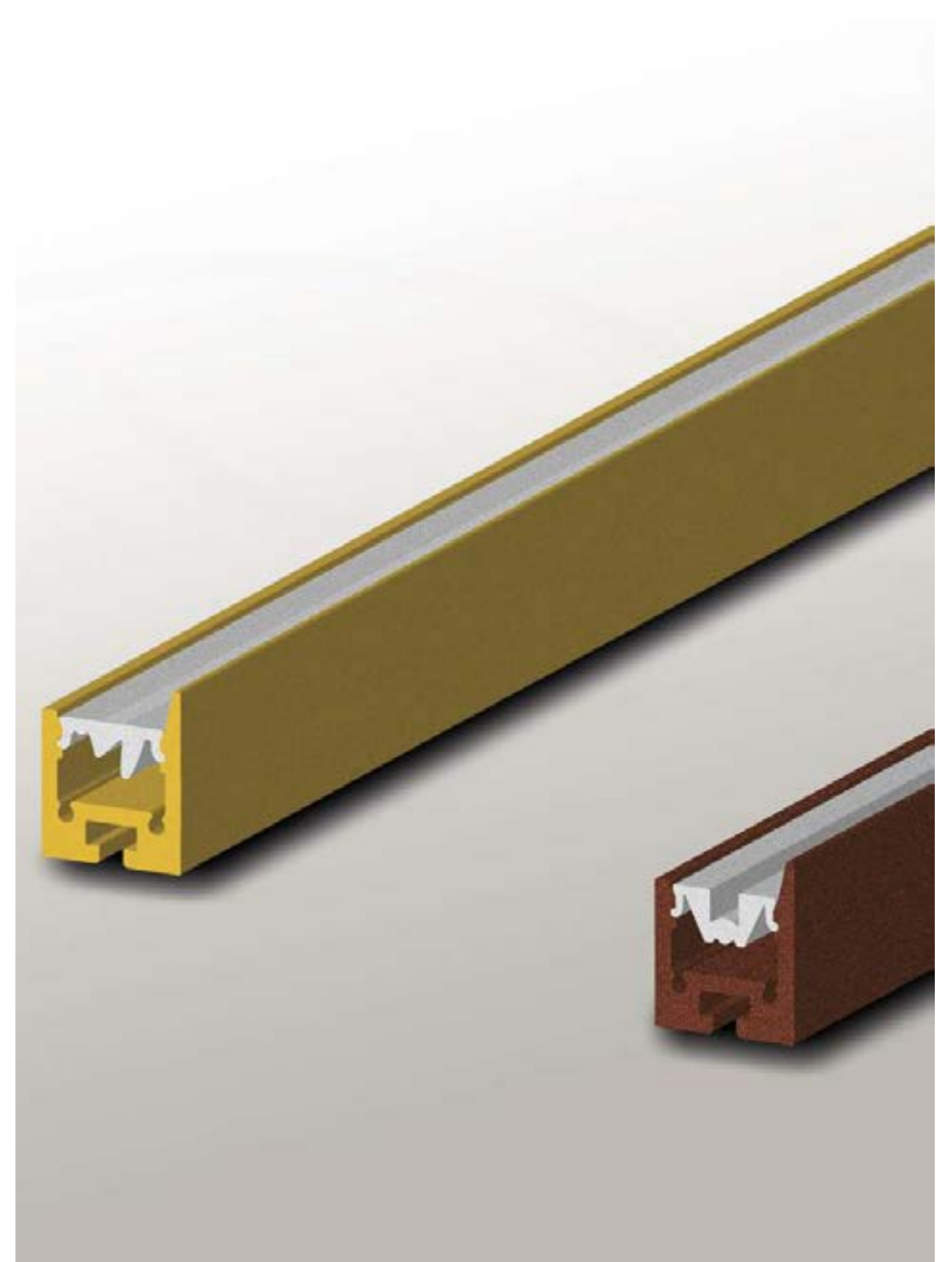

“altissimi livelli qualitativi e prestazionali”

La luce naturale incentiva la comunicazione il benessere e regola i ritmi biologici della vita. È la nostra risposta nella ricerca continua di creare una luce che trasmetta sensazioni stimolanti, aiuti nell'orientamento ed esprima qualità, soprattutto quando le architetture raggiungono altissimi livelli qualitativi e prestazionali. Q20 contribuisce a tutto questo grazie alle sue lenti e alla tecnologia led appositamente progettata per garantire la possibilità di studiare e personalizzare ogni tipo di progetto commerciale, museale.

Q20 Natural light stimulates communication, well-being and regulates the biological rhythms of life. It is our response in the continuous search to create a light that transmits stimulating sensations, helps in orientation and expresses quality, especially when the architectures reach the highest quality and performance levels. Q20 contributes to all this thanks to its lenses and LED technology specially designed to guarantee the possibility of studying and customizing any type of commercial, museum project.

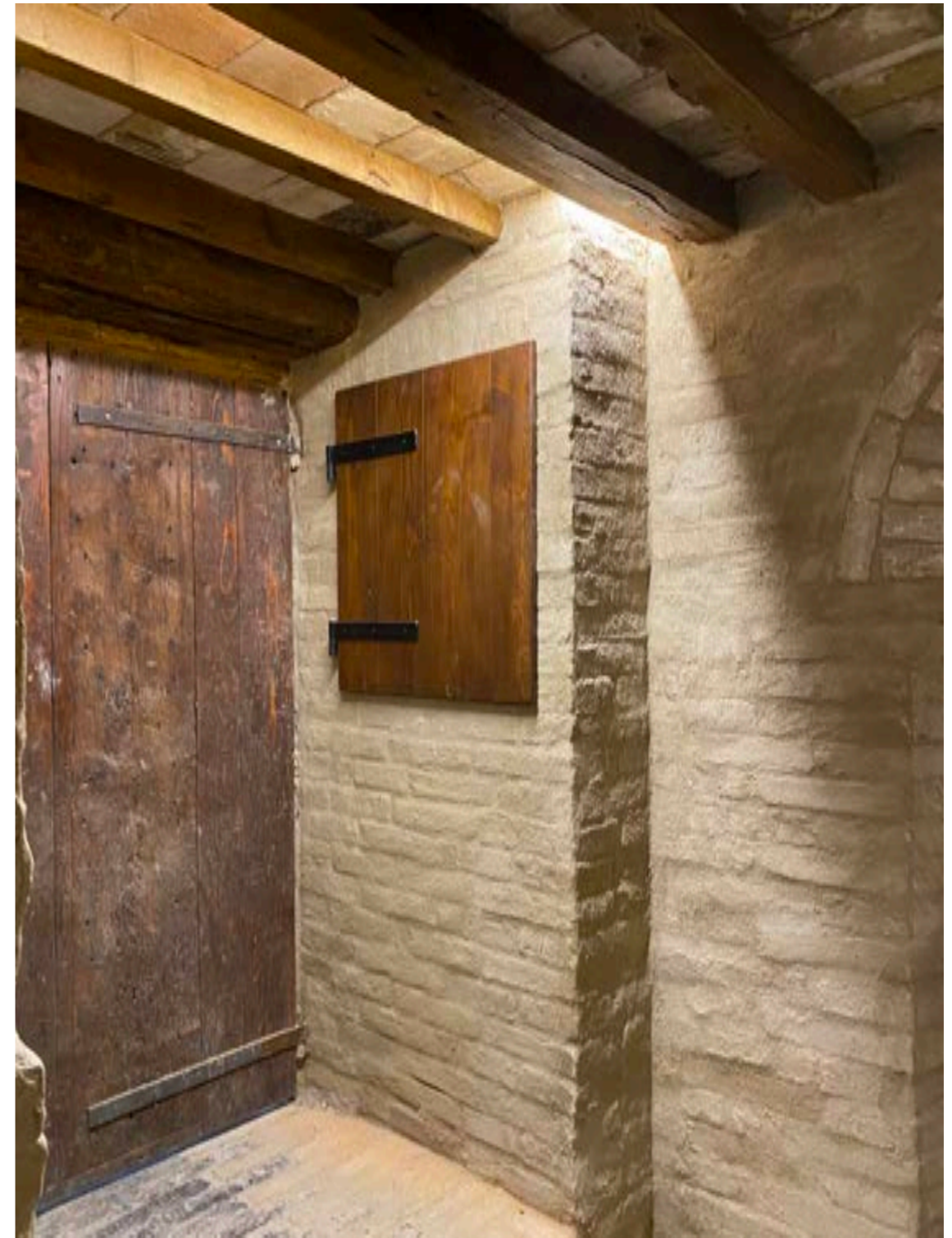



VERSIONE SPOT (15°)
SPOT VERSION (15°)

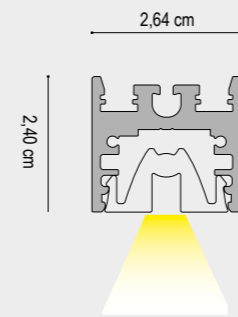

VERSIONE WALL WASHER (45°)
WALL WASHER VERSION (45°)

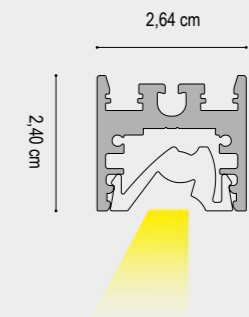

LE CONFIGURAZIONI RIPORTATE SONO COMPATIBILI PER LA VERSIONE SPOT E PER LA VERSIONE WALL WASHER.
THE CONFIGURATIONS SHOWN ARE COMPATIBLE FOR THE SPOT VERSION AND FOR THE WALL WASHER VERSION.

INSTALLAZIONE A SOSPENSIONE
SUSPENSION

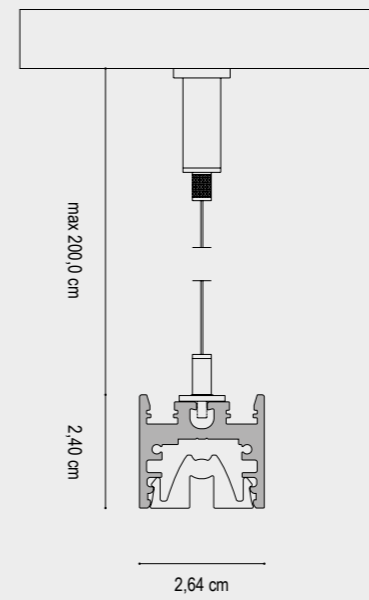

INSTALLAZIONE CON CLIP IN POLICARBONATO SU
SUPERFICIE ORIZZONTALE
INSTALLATION WITH POLYCARBONATE CLIP ON HORIZONTAL
SURFACE

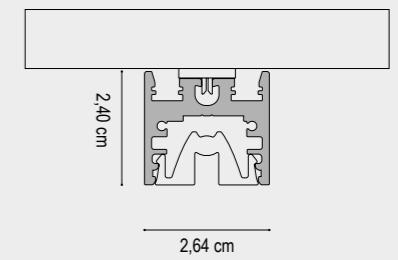

INSTALLAZIONE CON STAFFE MAGNETICHE SU SUPERFICIE METALLICA ORIZZONTALE
INSTALLATION WITH MAGNET ON HORIZONTAL METAL SURFACE

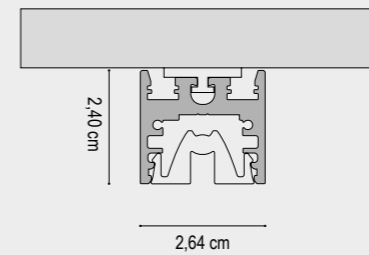

SI RACCOMANDA L'UTILIZZO DI N° 1 STAFFA
MAGNETICA OGNI 25,00 cm DI PROFILO. TALE
QUANTITÀ PUÒ VARIARE A SECONDA DELLA
SUPERFICIE METALLICA DI INSTALLAZIONE.

WE RECOMMEND THE USE OF N° 1 MAGNETIC
BRACKET EVERY 25.00 cm OF PROFILE.
THIS QUANTITY MAY VARY DEPENDING ON
THE METAL INSTALLATION SURFACE.

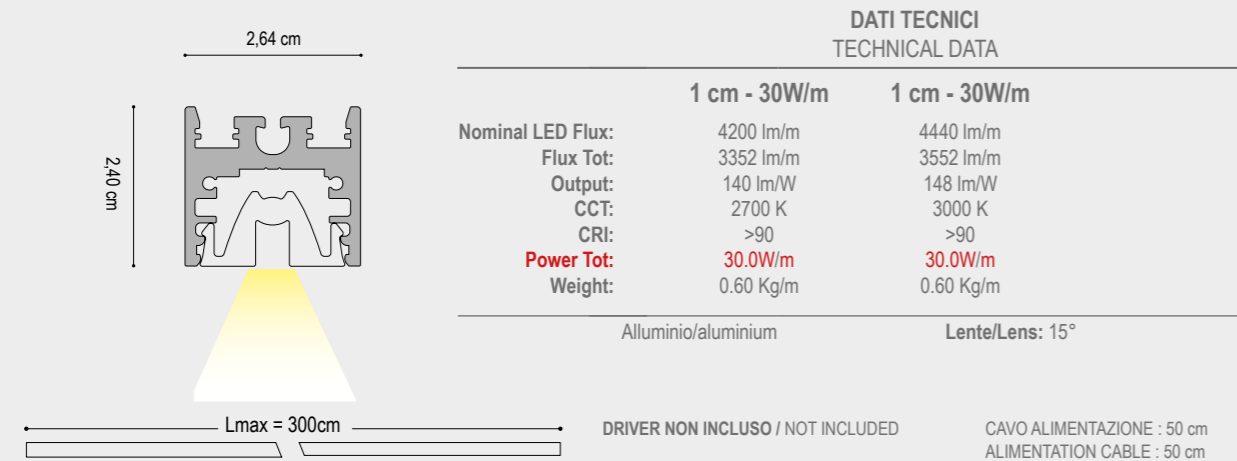

FINITURA STRUTTURA FINISHES	DIFFUSORE DIFFUSER	1 cm - 2700K	1 cm - 3000K
		CODICE CODE	CODICE CODE
GRIGIO VESUVIO ANTHRACITE	LENTE 15° / LENS 15°	298000S001	298100S001
ARGILLA CLAY		298001S001	298101S001
ARGENTO OPACO/MATT SILVER		298002S001	298102S001
BIANCO INTONACO/WHITE		298003S001	298103S001
NERO CARAVAGGIO BLACK		298004S001	298104S001
MOKA MOCHA		298005S001	298105S001
CROMO CHROME		298008S001	298108S001
ORO CALIFORNIA/GOLD		298009S001	298109S001
ARAMEN COPPER		298010S001	298110S001
ARGENTO COMETA/SILVER COMET		298012S001	298112S001
OTTONE VENEZIANO/VENETIAN BRASS		298013S001	298113S001
TITANIO/TITANIUM		298014S001	298114S001
BRONZO RIACI/RIACI BRONZE		298015S001	298115S001
VERDE COSTA/GREEN COAST		298016S001	298116S001
TERRA SENESE SENESE EARTH		298017S001	298117S001

N.B./P.N.: LUNGHEZZA MASSIMA VERSIONE CROMO = 2,00 m / MAXIMUM LENGTH CHROME VERSION = 2.00 m
TESTATE DI CHIUSURA NON INCLUSE / DEAD ENDS NOT INCLUDED

DIAGRAMMA FOTOMETRICO
LENTE SPOT - 15°

PHOTOMETRIC DIAGRAM
SPOT LENS - 15 °

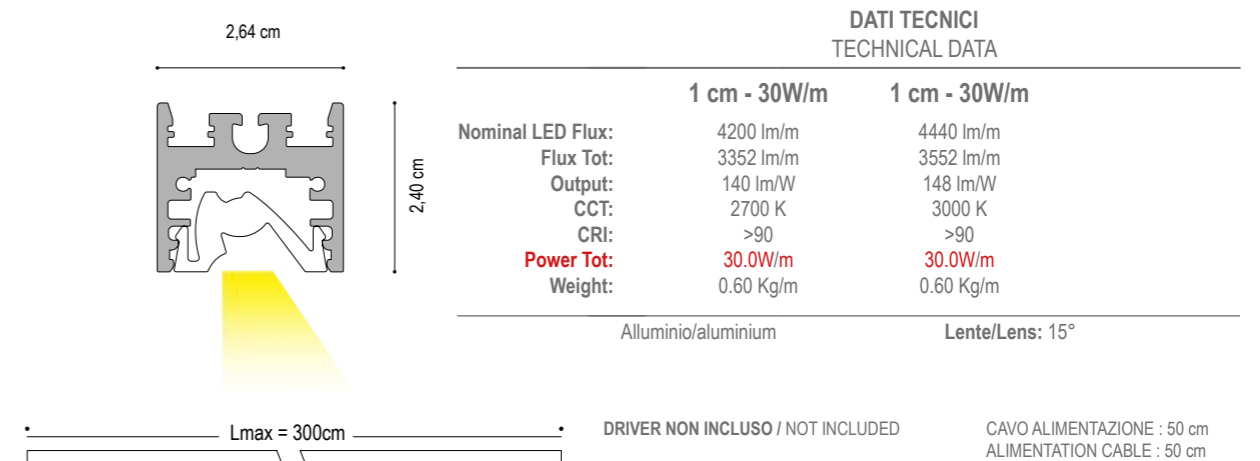
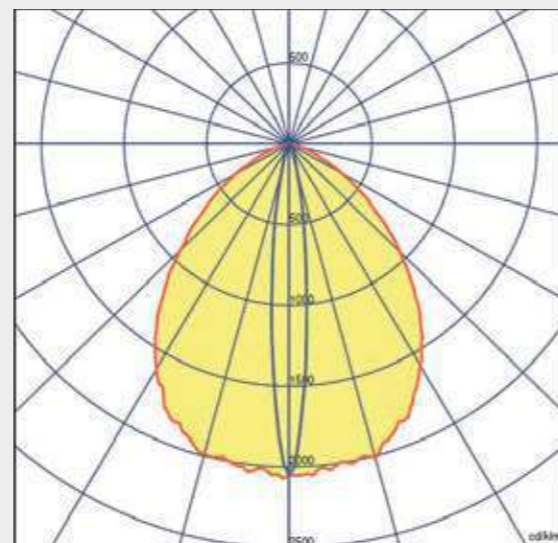

FINITURA STRUTTURA FINISHES	DIFFUSORE DIFFUSER	1 cm - 2700K	1 cm - 3000K
		CODICE CODE	CODICE CODE
GRIGIO VESUVIO ANTHRACITE	LENTE 45° / LENS 45°	298000W001	298100W001
ARGILLA CLAY		298001W001	298101W001
ARGENTO OPACO/MATT SILVER		298002W001	298102W001
BIANCO INTONACO/WHITE		298003W001	298103W001
NERO CARAVAGGIO BLACK		298004W001	298104W001
MOKA MOCHA		298005W001	298105W001
CROMO CHROME		298008W001	298108W001
ORO CALIFORNIA/GOLD		298009W001	298109W001
ARAMEN COPPER		298010W001	298110W001
ARGENTO COMETA/SILVER COMET		298012W001	298112W001
OTTONE VENEZIANO/VENETIAN BRASS		298013W001	298113W001
TITANIO/TITANIUM		298014W001	298114W001
BRONZO RIACI/RIACI BRONZE		298015W001	298115W001
VERDE COSTA/GREEN COAST		298016W001	298116W001
TERRA SENESE SENESE EARTH		298017W001	298117W001

N.B./P.N.: LUNGHEZZA MASSIMA VERSIONE CROMO = 2,00 m / MAXIMUM LENGTH CHROME VERSION = 2.00 m
TESTATE DI CHIUSURA NON INCLUSE / DEAD ENDS NOT INCLUDED

DIAGRAMMA FOTOMETRICO
LENTE WALL WASHER - 45°

PHOTOMETRIC DIAGRAM
WALL WASHER LENS - 45 °

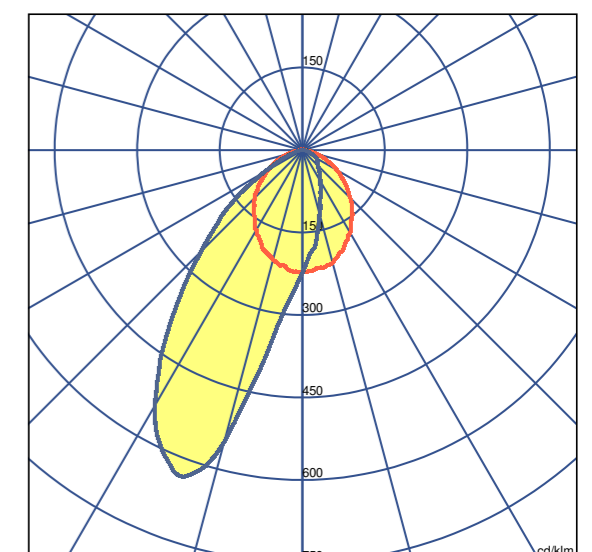

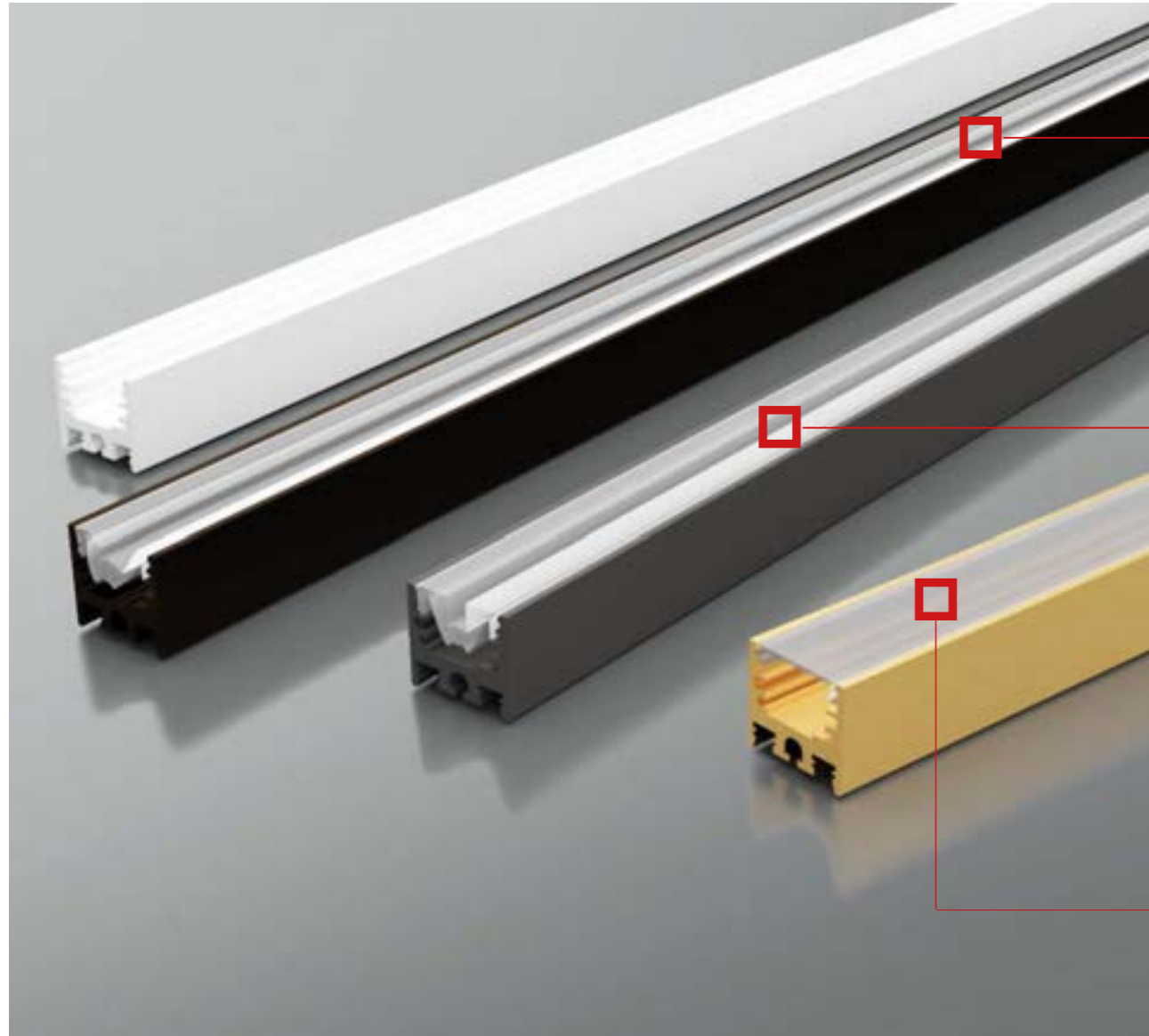

LENTE WALL WASHER - 45°
WALL WASHER LENS - 45 °

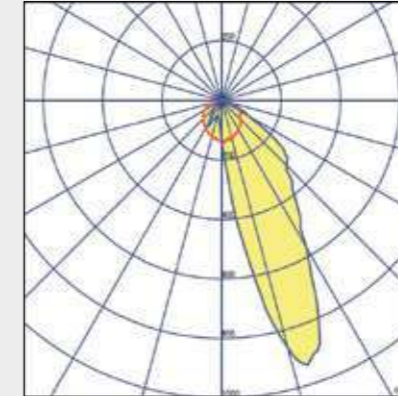

LENTE SPOT - 15°
SPOT LENS - 15 °

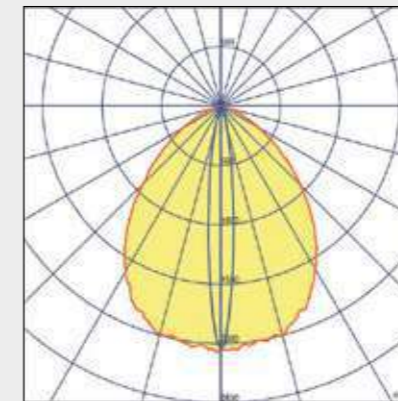

DIFFUSORE IN POLICARBONATO OPALE
OPAL POLYCARBONATE DIFFUSER

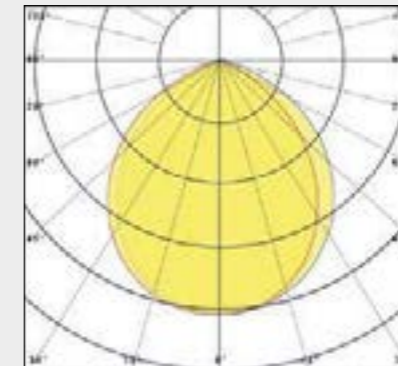

TESTATE DI CHIUSURA / DEAD ENDS

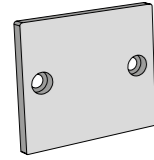

FINITURA STRUTTURA FINISHES	CODICE CODE	FINITURA STRUTTURA FINISHES	CODICE CODE
GRIGIO VESUVIO ANTHRACITE	290400	ARAMEN COPPER	290410
ARGILLA CLAY	290401	GRIGIO AVIO/GREY AVIO	290411
ARGENTO OPACO MATT SILVER	290402	ARGENTO COMETA/SILVER COMET	290412
BIANCO INTONACO/WHITE	290403	OTTONE VENEZIANO BRASS	290413
NERO CARAVAGGIO BLACK	290404	TITANIO/TITANIUM	290414
MOKA MOCHA	290405	BRONZO RIACI/RIACI BRONZE	290415
CROMO CHROME	290408	VERDE COSTA/GREEN COAST	290416
ORO CALIFORNIA/GOLD	290409	TERRA SENESE SENESE EARTH	290417

Il codice contiene 1 testata di chiusura con viti.
The code contains 1 closing warhead with screws.

GIUNTI / JOINTS

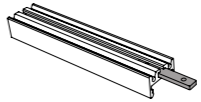
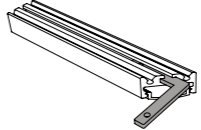
		FINITURA FINISHES	CODICE CODE
GIUNTO LINEA CONTINUA / STRAIGHT JOINT		ALLUMINIO NATURALE/ALUMINUM	1010500006
Accessorio per giunzioni meccaniche lineari Accessory for linear mechanical joints			
GIUNTO 90° ORIZZONTALE / HORIZONTAL JOINT 90°		ALLUMINIO NATURALE/ALUMINUM	1010500005
Accessorio per giunzioni meccaniche con angolo 90° Accessory for linear mechanical joints with 90° angle			

Il codice contiene i grani per il fissaggio del giunto.
The code contains the grains to fix the joint.

STAFFA DI FISSAGGIO A DOPPIO ATTACCO / DOUBLE MOUNTING CLIP CALAMITA / MAGNET



FINITURA FINISHES	CODICE CODE	PREZZO	FINITURA FINISHES	CODICE CODE	PORTATA RANGE
SUPERFICI PIANE 2mm EVEN SURFACE 2mm	1020500005			1020500010	1 Kg
SUPERFICI IRREGOLARI 3,9mm UNEVEN SURFACE 3,9 mm	1020500006			1020500210	2 Kg

Accessorio per fissaggio a plafone/superficie. Quantità raccomandata: 1 pz ogni 50 cm di modello.

Ceiling/surface mounting accessory. Recommended quantity 1 pc every 50 cm of model.

Quantità raccomandata: 1 pz ogni 25 cm di modello.

Recommended quantity: 1 pc every 25 cm of model.

LAVORAZIONI / PROCESSING

DATI TECNICI TECHNICAL DATA	CODICE CODE
TAGLIO 90° ORIZZONTALE (PER ANGOLI FORMATI DA DUE PROFILI) HORIZONTAL 90 ° CUT (FOR CORNERS MADE OF TWO PROFILES)	190X
TAGLIO ANGOLARE CUSTOM (PER ANGOLI FORMATI DA DUE PROFILI) CUSTOM CORNER CUT (FOR CORNERS MADE OF TWO PROFILES)	190N
ASOLA / SLOT	100A
ASOLA CUSTOM/ SLOT CUSTOM	100N
FORO / HOLE	100F

KIT DI SOSPENSIONE / SUSPENSION KIT

DATI TECNICI
TECHNICAL DATAARTICOLI INCLUSI NEL CODICE
ARTICLES INCLUDED IN THE CODE

Cavo in acciaio 2,00m con puntalino
2.00m steel cable with tip
Boccola cromata con regolazione millimetrica
Chrome bush with millimeter adjustment
Archetto in alluminio per sospensione
Aluminum arch for suspension

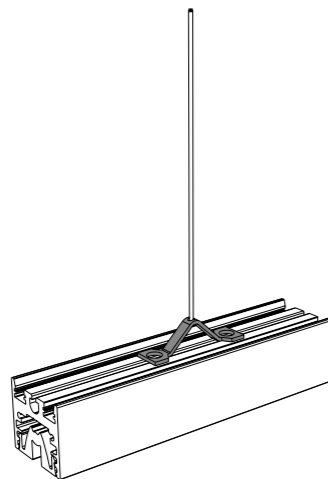

FINITURA STRUTTURA FINISHES	CODICE CODE
GRIGIO VESUVIO ANTHRACITE	1040500004
ARGILLA CLAY	1040501004
ARGENTO OPACO MATT SILVER	1040502004
BIANCO INTONACO/WHITE	1040503004
NERO CARAVAGGIO BLACK	1040504004
MOKA MOCHA	1040505004
CROMO CHROME	1040508004
ORO CALIFORNIA/GOLD	1040509004
ARAMEN COPPER	1040510004
GRIGIO AVIO/GREY AVIO	1040511004
ARGENTO COMETA/SILVER COMET	1040512004
OTTONE VENEZIANO BRASS	1040513004
TITANIO/TITANIUM	1040514004
BRONZO RIACI/RIACI BRONZE	1040515004
VERDE COSTA/GREEN COAST	1040516004
TERRA SENESE SENESE EARTH	1040517004

“articolata serie di soluzioni”

La selezione di ottiche e schermi disponibili è stata studiata per offrire un'articolata serie di soluzioni, ognuna adatta a realizzare scenografi e luminose negli ambienti, senza trascurare il comfort visivo e garantendo la valorizzazione degli spazi. STRUCTURAE, grazie all'ampia gamma di accessori, permette di realizzare infinite combinazioni e di adattarsi ad ogni esigenza, rispettando il design di tutti i contesti.

The large selection of cover and optics are designed to offer infinite solutions, each of that can realize wonderful light scenes in the environments without overlook the visual comfort and at the same time exalting the spaces. According to the high disposability of accessories, STRUCTURAE could realize lot of combinations and could be adapted to the needs of everyone, respecting the design everywhere.



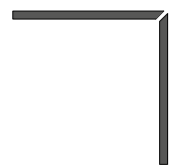

A. COMPOSIZIONE ANGOLARE A "L"
A. L-ANGLE COMPOSITION

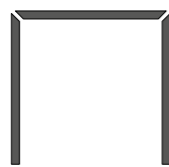

B. COMPOSIZIONE ANGOLARE A "C"
B. C-ANGLE COMPOSITION

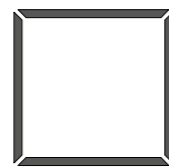

C. COMPOSIZIONE POLIGONALE (QUADRATO/RETTANGOLO)
C. POLYGONAL COMPOSITION (SQUARE / RECTANGLE)



D. COMPOSIZIONE POLIGONALE (PENTAGONO/ESAGONO)
D. POLYGONAL COMPOSITION (PENTAGON / HEX)

INSTALLAZIONE A SOSPENSIONE
SUSPENSION

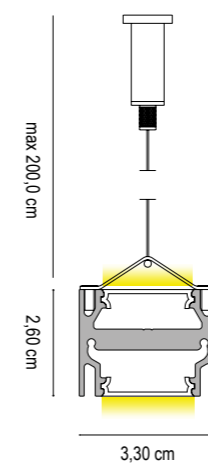

INSTALLAZIONE A PARETE
WALL INSTALLATION

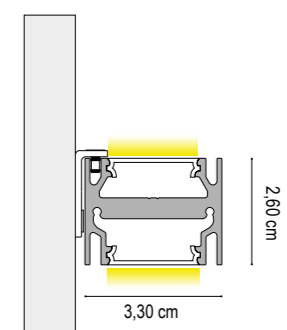

structurae

led integrato

integrated led

DATI TECNICI
TECHNICAL DATA

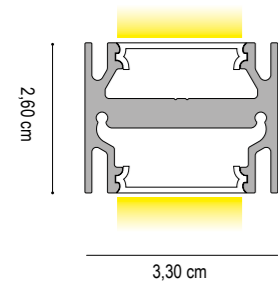

	1 cm - 40W/m	200 cm - 80W	300 cm - 120W
Nominal LED Flux:	↑ 2200 lm/m - 2200 lm/m ↓	↑ 4400 lm - 4400 lm ↓	↑ 6600 lm - 6600 lm ↓
Flux Tot:	↑ 1760 lm/m - 1760 lm/m ↓	↑ 3520 lm - 3520 lm ↓	↑ 5280 lm - 5280 lm ↓
Output:	110 lm/W	110 lm/W	110 lm/W
CCT:	3000 K	3000 K	3000 K
CRI:	>95	>95	>95
Power:	↑ 19.2W/m - 19.2W/m ↓	↑ 38.4W - 38.4W ↓	↑ 57.6W - 57.6W ↓
Power Tot:	38.4W/m	76.8W	115.2W
Weight:	1.40 Kg/m	2.80 Kg	4.20 Kg

Alluminio/aluminium

Cover: Opale/opal - Satinato/Satin

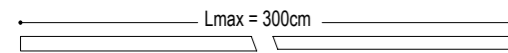

DRIVER NON INCLUSO / NOT INCLUDED

CAVO ALIMENTAZIONE : 50 cm
ALIMENTATION CABLE : 50 cm

FINITURA STRUTTURA
FINISHES

- GRIGIO VESUVIO ANTHRACITE
- ARGILLA ARGIL
- ARGENTO OPACO/MATT SILVER
- BIANCO INTONACO/WHITE
- NERO CARAVAGGIO BLACK
- MOKA MOCHA
- ORO CALIFORNIA GOLD
- ARAMEN COPPER
- GRIGIO AVIO GREY AVIO
- ARGENTO COMETA/SILVER COMET
- OTTONE VENEZIANO BRASS
- TITANIO/TITANIUM
- BRONZO RIACI/RIACI BRONZE
- VERDE COSTA/GREEN COAST
- TERRA SENESE SENESE EARTH
- CROMO/CHROME

DIFFUSORE
DIFFUSER

- SATINATA/SATIN
- OPALE/OPAL

	1 cm	200 cm	300 cm
CODICE CODE			
	104260001	104260020	104260030
	104260101	104260120	104260130
	104260201	104260220	104260230
	104260301	104260320	104260330
	104260401	104260420	104260430
	104260501	104260520	104260530
	104260901	104260920	104260930
	104261001	104261020	104261030
	104261101	104261120	104261130
	104261201	104261220	104261230
	104261301	104261320	104261330
	104261401	104261420	104261430
	104261501	104261520	104261530
	104261601	104261620	104261630
	104261701	104261720	104261730
	104260801	104260820	

N.B./P.N.:

LUNGHEZZA MASSIMA VERSIONE CROMO = 2,00 m / MAXIMUM LENGTH CHROME VERSION = 2.00 m
TESTATE DI CHIUSURA NON INCLUSE / DEAD ENDS NOT INCLUDED

nb: per temperatura colore 2700k codice : 104**25**.....

nb: per temperatura colore 4000k codice : 104**27**.....

structurae

led integrato

integrated led

DATI TECNICI
TECHNICAL DATA

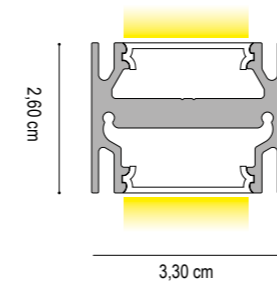

	1 cm - 40W/m	200 cm - 80W	300 cm - 120W
Nominal LED Flux:	↑ 4440 lm/m - 4440 lm/m ↓	↑ 8880 lm - 8880 lm ↓	↑ 13320 lm - 13320 lm ↓
Flux Tot:	↑ 3552 lm/m - 3552 lm/m ↓	↑ 7104 lm - 7104 lm ↓	↑ 10656 lm - 10656 lm ↓
Output:	148 lm/W	148 lm/W	148 lm/W
CCT:	3000 K	3000 K	3000 K
CRI:	>90	>90	>90
Power:	↑ 30.0W/m - 30.0W/m ↓	↑ 60.0W - 60.0W ↓	↑ 90.0W - 90.0W ↓
Power Tot:	60.0W/m	120.0W	180.0W
Weight:	1.40 Kg/m	2.80 Kg	4.20 Kg

Alluminio/aluminium

Cover: Opale/opal - Satinato/Satin

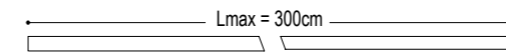

DRIVER NON INCLUSO / NOT INCLUDED

CAVO ALIMENTAZIONE : 50 cm
ALIMENTATION CABLE : 50 cm

FINITURA STRUTTURA
FINISHES

- GRIGIO VESUVIO ANTHRACITE
- ARGILLA ARGIL
- ARGENTO OPACO/MATT SILVER
- BIANCO INTONACO/WHITE
- NERO CARAVAGGIO BLACK
- MOKA MOCHA
- ORO CALIFORNIA GOLD
- ARAMEN COPPER
- GRIGIO AVIO GREY AVIO
- ARGENTO COMETA/SILVER COMET
- OTTONE VENEZIANO BRASS
- TITANIO/TITANIUM
- BRONZO RIACI/RIACI BRONZE
- VERDE COSTA/GREEN COAST
- TERRA SENESE SENESE EARTH
- CROMO/CHROME

DIFFUSORE
DIFFUSER

- SATINATA/SATIN
- OPALE/OPAL

	1 cm	200 cm	300 cm
CODICE CODE			
	104810001	104810020	104810030
	104810101	104810120	104810130
	104810201	104810220	104810230
	104810301	104810320	104810330
	104810401	104810420	104810430
	104810501	104810520	104810530
	104810901	104810920	104810930
	104811001	104811020	104811030
	104811101	104811120	104811130
	104811201	104811220	104811230
	104811301	104811320	104811330
	104811401	104811420	104811430
	104811501	104811520	104811530
	104811601	104811620	104811630
	104811701	104811720	104811730
	104810801	104810820	

N.B./P.N.:

LUNGHEZZA MASSIMA VERSIONE CROMO = 2,00 m / MAXIMUM LENGTH CHROME VERSION = 2.00 m
TESTATE DI CHIUSURA NON INCLUSE / DEAD ENDS NOT INCLUDED

nb: per temperatura colore 2700k codice : 104**80**.....

nb: per temperatura colore 4000k codice : 104**82**.....



LED compatibili / LED compatibility

HIGH QUALITY CRI>90 CRI>95	HIGH OUTPUT CRI>90 CRI>95	HIGH EFFICIENT CRI>90 CRI>95	HIGH INTENSITY CRI>90 CRI>95	LOW POWER CRI>90	ULTRA SLIM CRI>90 CRI>95 CRI>97	RGB	RGB WHITE	RGB TW	TUNABLE WHITE
9,6W 14,4W 19,2W	12,3W 14,4W 19,2W 20W 24W	12,3W 14,4W 19,2W 20W 24W	24W 24W (700 LED)	6W	9,6W 12W 14,4W	14W	14W	14,4W 23W	19,2W

DIFFUSORE

	1 cm	200 cm	300 cm
	DIFFUSORE DIFFUSER OPAL/OPAL SATINATA/SATIN PRISMATIZZATO/PRISMATIC	CODICE CODE 103010001 103010101 1030113001	CODICE CODE 1030100200 1030101200 1030113200
		CODICE CODE 1030100300 1030101300 1030113300	

LENTE

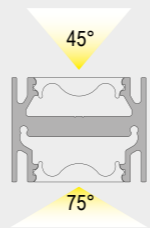
	1 cm	200 cm
	DIFFUSORE DIFFUSER LENTE 45°/LENS 45° LENTE 75°/LENS 75°	CODICE CODE 1040245001 1040275001
		CODICE CODE 1040245200 1040275200

L'AMPIEZZA DEL FASCIO LUMINOSO IN USCITA VARIA A SECONDA DELLA DISTANZA TRA IL LED E LA LENTE
 THE AMPLITUDE OF THE LIGHT BEAM IN VARIOUS OUTPUTS DEPENDING ON THE DISTANCE BETWEEN THE LED AND THE LENS

TESTATE DI CHIUSURA / DEAD ENDS

FINITURA STRUTTURA FINISHES	CODICE CODE	FINITURA STRUTTURA FINISHES	CODICE CODE
GRIGIO VESUVIO ANTHRACITE	1040400000	ARAMEN COPPER	1040410000
ARGILLA CLAY	1040401000	GRIGIO AVIO GREY AVIO	1040411000
ARGENTO OPACO MATT SILVER	1040402000	ARGENTO COMETA SILVER COMET	1040412000
BIANCO INTONACO WHITE	1040403000	OTTONE VENEZIANO BRASS	1040413000
NERO CARAVAGGIO BLACK	1040404000	TITANIO TITANIUM	1040414000
MOKA MOCHA	1040405000	BRONZO RIACI RIACI BRONZE	1040415000
CROMO CHROME	1040408000	VERDE COSTA GREEN COAST	1040416000
ORO CALIFORNIA GOLD	1040409000	TERRA SENESE SENESE EARTH	1040417000

Il codice contiene 1 testata di chiusura con viti.
 The code contains 1 closing warhead with screws.



FINITURA STRUTTURA
FINISHES

GRIGIO VESUVIO ANTHRACITE
ARGILLA ARGIL
ARGENTO OPACO MATT SILVER
BIANCO INTONACO WHITE
NERO CARAVAGGIO BLACK
MOKA MOCHA
ORO CALIFORNIA GOLD
ARAMEN COPPER
GRIGIO AVIO GREY AVIO
ARGENTO COMETA SILVER COMET
OTTONE VENEZIANO BRASS
TITANIO TITANIUM
BRONZO RIACI RIACI BRONZE
VERDE COSTA GREEN COAST
TERRA SENESE SENESE EARTH
CROMO CHROME

	1 cm	200 cm	300 cm
CODICE CODE		CODICE CODE	CODICE CODE
1040300001	1040300200	1040300300	1040300300
1040301001	1040301200	1040301300	1040301300
1040302001	1040302200	1040302300	1040302300
1040303001	1040303200	1040303300	1040303300
1040304001	1040304200	1040304300	1040304300
1040305001	1040305200	1040305300	1040305300
1040309001	1040309200	1040309300	1040309300
1040310001	1040310200	1040310300	1040310300
1040311001	1040311200	1040311300	1040311300
1040312001	1040312200	1040312300	1040312300
1040313001	1040313200	1040313300	1040313300
1040314001	1040314200	1040314300	1040314300
1040315001	1040315200	1040315300	1040315300
1040316001	1040316200	1040316300	1040316300
1040317001	1040317200	1040317300	1040317300
1040308001	1040308200		

N.B./P.N.:
 LUNGHEZZA MASSIMA VERSIONE CROMO = 2,00 m / MAXIMUM LENGTH CHROME VERSION = 2.00 m

GIUNTI / JOINTS

DATI TECNICI
TECHNICAL DATA

GIUNTO LINEA CONTINUA / STRAIGHT JOINTS

Accessorio per giunzioni meccaniche lineari compreso di grani di fissaggio
Accessory for linear joints included of fixing grains

N.B. consigliamo n°02 giunti per prodotto
N.B. We recommend n°02 joints for product

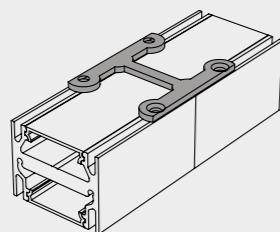

FINITURA STRUTTURA
FINISHES

FINITURA STRUTTURA FINISHES	CODICE CODE
GRIGIO VESUVIO ANTHRACITE	104050001
ARGILLA ARGIL	1040501001
ARGENTO OPACO MATT SILVER	1040502001
BIANCO INTONACO/WHITE	1040503001
NERO CARAVAGGIO BLACK	1040504001
MOKA MOCHA	1040505001
CROMO CHROME	1040508001
ORO CALIFORNIA/GOLD	1040509001
ARAMEN COPPER	1040510001
GRIGIO AVIO/GREY AVIO	1040511001
ARGENTO COMETA/SILVER COMET	1040512001
OTTONE VENEZIANO BRASS	1040513001
TITANIO/TITANIUM	1040514001
BRONZO RIACI/RIACI BRONZE	1040515001
VERDE COSTA/GREEN COAST	1040516001
TERRA SENESE SENESE EARTH	1040517001

GRIGIO VESUVIO ANTHRACITE	1040500005
ARGILLA ARGIL	1040501005
ARGENTO OPACO MATT SILVER	1040502005
BIANCO INTONACO/WHITE	1040503005
NERO CARAVAGGIO BLACK	1040504005
MOKA MOCHA	1040505005
CROMO CHROME	1040508005
ORO CALIFORNIA/GOLD	1040509005
ARAMEN COPPER	1040510005
GRIGIO AVIO/GREY AVIO	1040511005
ARGENTO COMETA/SILVER COMET	1040512005
OTTONE VENEZIANO BRASS	1040513005
TITANIO/TITANIUM	1040514005
BRONZO RIACI/RIACI BRONZE	1040515005
VERDE COSTA/GREEN COAST	1040516005
TERRA SENESE SENESE EARTH	1040517005

GIUNTO 90° ORIZZONTALE / HORIZONTAL JOINTS 90°

Accessorio per giunzioni meccaniche con angoli 90° compreso di grani di fissaggio
Accessory for angular 90° joints included of fixing grains

N.B. consigliamo n°02 giunti per prodotto
N.B. We recommend n°02 joints for product

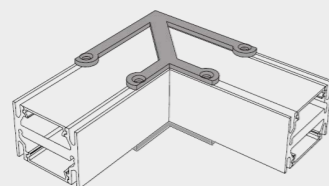

STAFFA DI FISSAGGIO A PARETE / WALL MOUNTING CLIP

DATI TECNICI
TECHNICAL DATA

MATERIALE: Alluminio naturale
MATERIAL: Natural aluminium

Nel codice è compresa la vite per il fissaggio della staffa al modello
The code includes the screw for fixing the bracket to the model

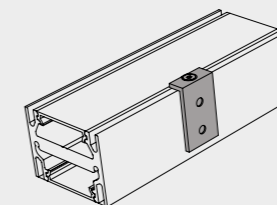

FINITURA STRUTTURA
FINISHES

GRIGIO VESUVIO ANTHRACITE	1040500002
ARGILLA ARGIL	1040501002
ARGENTO OPACO MATT SILVER	1040502002
BIANCO INTONACO/WHITE	1040503002
NERO CARAVAGGIO BLACK	1040504002
MOKA MOCHA	1040505002
CROMO CHROME	1040508002
ORO CALIFORNIA/GOLD	1040509002
ARAMEN COPPER	1040510002
GRIGIO AVIO/GREY AVIO	1040511002
ARGENTO COMETA/SILVER COMET	1040512002
OTTONE VENEZIANO BRASS	1040513002
TITANIO/TITANIUM	1040514002
BRONZO RIACI/RIACI BRONZE	1040515002
VERDE COSTA/GREEN COAST	1040516002
TERRA SENESE SENESE EARTH	1040517002

LAVORAZIONI / PROCESSING

DATI TECNICI
TECHNICAL DATA



TAGLIO 90° ORIZZONTALE (PER ANGOLI FORMATI DA DUE PROFILI)
HORIZONTAL 90 ° CUT (FOR CORNERS MADE OF TWO PROFILES)

CODICE
CODE

190X



TAGLIO ANGOLARE CUSTOM (PER ANGOLI FORMATI DA DUE PROFILI)
CUSTOM CORNER CUT (FOR CORNERS MADE OF TWO PROFILES)

190N



ASOLA / SLOT

100A



ASOLA CUSTOM / SLOT CUSTOM

100N



FORO / HOLE

100F



CABLAGGIO - COLLAUDO - CE AL CENTIMETRO
INSTALLATION AND TESTING LED MODULE AT CENTIMETER

1041



CONNETTORE MASCHIO/FEMMINA
MALE/FEMALE CONNECTOR

98CFM

CONNETTORE MASCHIO/FEMMINA MONTATO NEL PRODOTTO
MALE/FEMALE CONNECTOR FITTED IN THE PRODUCT

98MFM

CAVO DI ALIMENTAZIONE 2X0,75 TONDO TRASPARENTE 1CM
POWER CABLE 2X0,75 ROUND TRANSPARENT 1CM

98CTT001

GIUNTO LINEA CONTINUA INTEGRATO A KIT DI SOSPENSIONE /
CONTINUES LINE JOINT INTEGRATED TO SUSPENSION KIT

DATI TECNICI

TECHNICAL DATA

Accessorio per giunzioni meccaniche lineari e per fissaggio a sospensione dei profili.

Accessory for linear mechanical joints and for suspended fixing of profiles.

ARTICOLI INCLUSI NEL CODICE

ARTICOLI INCLUSI NEL CODICE

Cavo in acciaio 2,00m con puntalino 2.00mm steel c

Boccola cromata con regolazione millimetrica / Chromed bushing with millimetric adjustment

Giunto meccanico lineare con regolazione millimetrica / Linear mechanical joint with millimetric adjustment

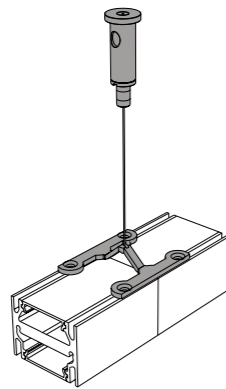

FINITURA STRUTTURA
FINISHES

CODICE
CODE

GRIGIO VESUVIO ANTHRACITE	104050003
ARGILLA ARGIL	104050103
ARGENTO OPACO MATT SILVER	104050203
BIANCO INTONACO/WHITE	104050303
NERO CARAVAGGIO BLACK	104050403
MOKA MOCHA	104050503
CROMO CHROME	104050803
ORO CALIFORNIA/GOLD	104050903
ARAMEN COPPER	104051003
GRIGIO AVIO/GREY AVIO	104051103
ARGENTO COMETA/SILVER COMET	104051203
OTTONE VENEZIANO BRASS	104051303
TITANIO/TITANIUM	104051403
BRONZO RIACI/RIACI BRONZE	104051503
VERDE COSTA/GREEN COAST	104051603
TERRA SENESE SENESE EARTH	104051703

KIT DI SOSPENSIONE / SUSPENSION KIT

DATI TECNICI
TECHNICAL DATA

ARTICOLI INCLUSI NEL CODICE
ARTICLES INCLUDED IN THE CODE

Cavo in acciaio 2,00m con puntalino
2.00m steel cable with tip
Boccola cromata con regolazione millimetrica
Chrome bush with millimeter adjustment
Archetto in alluminio per sospensione
Aluminum arch for suspension

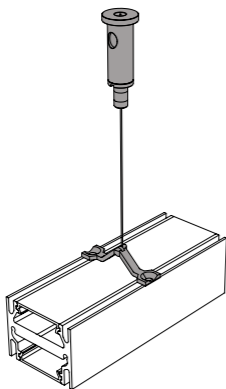

FINITURA STRUTTURA
FINISHES

CODICE
CODE

GRIGIO VESUVIO ANTHRACITE	104050004
ARGILLA ARGIL	104050104
ARGENTO OPACO MATT SILVER	104050204
BIANCO INTONACO/WHITE	104050304
NERO CARAVAGGIO BLACK	104050404
MOKA MOCHA	104050504
CROMO CHROME	104050804
ORO CALIFORNIA/GOLD	104050904
ARAMEN COPPER	104051004
GRIGIO AVIO/GREY AVIO	104051104
ARGENTO COMETA/SILVER COMET	104051204
OTTONE VENEZIANO BRASS	104051304
TITANIO/TITANIUM	104051404
BRONZO RIACI/RIACI BRONZE	104051504
VERDE COSTA/GREEN COAST	104051604
TERRA SENESE SENESE EARTH	104051704

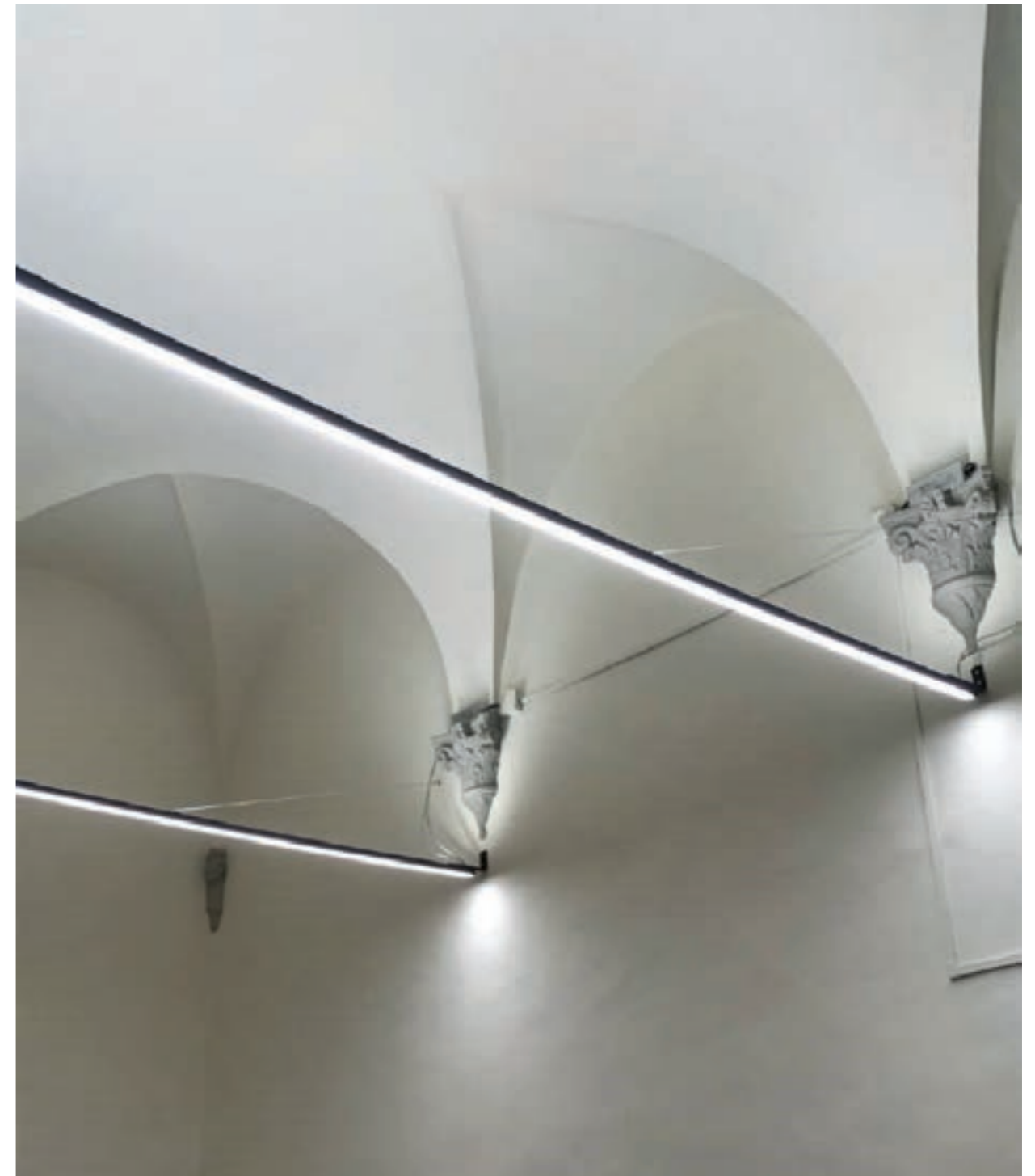

“basse luminanze, elevati CRI”

La nuova famiglia K è il risultato di lavoro duro, dedizione, talento, entusiasmo e passione che ogni persona nella nostra azienda ha messo in questo straordinario progetto, permettendoci di presentare a tutta la nostra clientela nazionale ed internazionale profili evoluti. Design Luce è stata la prima azienda italiana a proporre una gamma con elevate prestazioni, personalità, bellezza e qualità tipiche del made in Italy. K40 è stato pensato per integrare al suo interno elementi ottici, consentendoci di ottenere basse luminanze e impiegare al meglio sorgenti luminose a led di ultima generazione con elevati CRI fino a 95 e con la più alta efficienza energetica (fino a 150lm/W). La gamma di finiture, la personalizzazione del progetto, caratteristica ormai consolidate della nostra azienda, rendono questa famiglia uno strumento indispensabile per il progettista.

The new range of “K” products is the outcome of hard work, dedication, talent, enthusiasm and passion that the staff of Design Luce dedicated to this extraordinary project. Design Luce is now the first Italian company able to offer advanced aluminum lighting profiles with high performance, personality, beauty and quality typical of Made in Italy. K40 is designed to integrate excellent optical and thermal elements to allowing to use at the best the performance of the last generations of LED light sources with CRI up to 95 and the highest energy efficiency (up to 150 lm/W). The range of finishes, the customization of the project, a well-established feature of our company, make this family an indispensable tool for designers and architects.



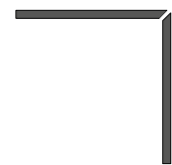
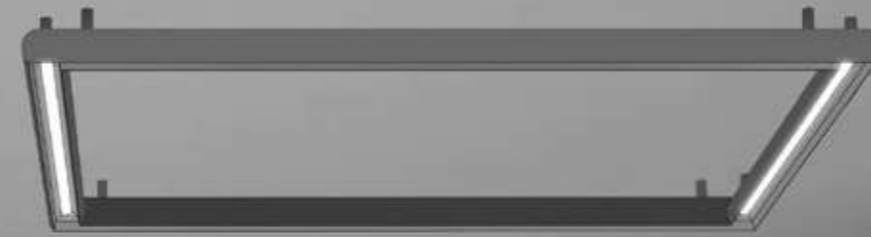

A. COMPOSIZIONE ANGOLARE A "L"
A. L-ANGLE COMPOSITION

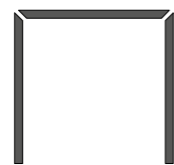

B. COMPOSIZIONE ANGOLARE A "C"
B. C-ANGLE COMPOSITION

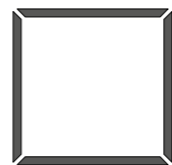

C. COMPOSIZIONE POLIGONALE (QUADRATO/RETTANGOLO)
C. POLYGONAL COMPOSITION (SQUARE / RECTANGLE)

INSTALLAZIONE A SOSPENSIONE PRODOTTO BIEMISSIONE
SUSPENSION BIEMISSION PRODUCT

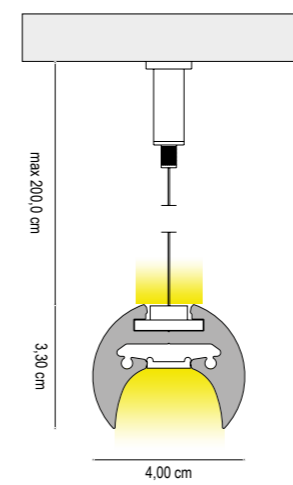

INSTALLAZIONE A SOFFITTO CON DISTANZIALE PRODOTTO MONOEMISSIONE
CEILING INSTALLATION WITH SPACER MONO EMISSION PRODUCT

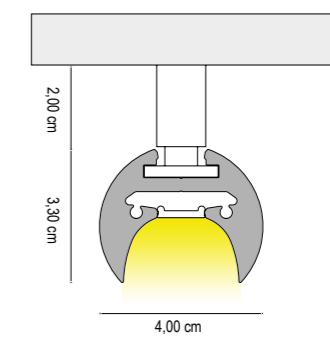

k40

led integrato

integrated led

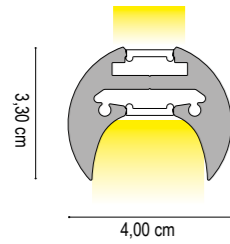

DATI TECNICI
TECHNICAL DATA

	1 cm - 24W/m	1 cm - 40W/m
Nominal LED Flux:	↑ 1900 lm/m - 1900 lm/m ↓	↑ 2200 lm/m - 2200 lm/m ↓
Flux Tot:	↑ 1520 lm/m - 1520 lm/m ↓	↑ 1760 lm/m - 1760 lm/m ↓
Output:	158 lm/W	105 lm/W
CCT:	3000 K	3000 K
CRI:	>90	>95
Power:	↑ 12.0W/m - 12.0W/m ↓	↑ 20.0W/m - 20.0W/m ↓
Power Tot:	24.0W/m	40.0W/m
Weight:	1.40 Kg/m	1.40 Kg/m

Alluminio/aluminium

Cover: Opale/opal - Satinato/Satin

DRIVER NON INCLUSO / NOT INCLUDED

CAVO ALIMENTAZIONE : 50 cm
ALIMENTATION CABLE : 50 cm

Lmax = 300cm

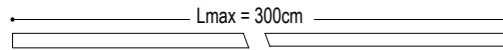

1 cm - 24W/m

1 cm - 40W/m

FINITURA STRUTTURA FINISHES	DIFFUSORE DIFFUSER	1 cm - 24W/m		1 cm - 40W/m	
		CODICE 2700K CODE 2700K	CODICE 3000K CODE 3000K	CODICE 2700K CODE 2700K	CODICE 3000K CODE 3000K
GRIGIO VESUVIO ANTHRACITE		2054000001	2055000001	2046000001	2047000001
ARGILLA CLAY		2054010001	2055010001	2046010001	2047010001
BIANCO INTONACO/WHITE		2054030001	2055030001	2046030001	2047030001
NERO CARAVAGGIO/BLACK		2054040001	2055040001	2046040001	2047040001
MOKA MOCHA		2054050001	2055050001	2046050001	2047050001
CROMO/CHROME		2054080001	2055080001	2046080001	2047080001
ORO CALIFORNIA/GOLD	SATINATA/SATIN	2054090001	2055090001	2046090001	2047090001
ARAMEN COPPER	OPALE/OPAL	2054100001	2055100001	2046100001	2047100001
GRIGIO AVIO/ GREY AVIO		2054110001	2055110001	2046110001	2047110001
OTTONE VENEZIANO/ VENETIAN BRASS		2054130001	2055130001	2046130001	2047130001
TITANIO/TITANIUM		2054140001	2055140001	2046140001	2047140001
BRONZO RIACI/RIACI BRONZE		2054150001	2055150001	2046150001	2047150001
VERDE COSTA/ GREEN COAST		2054160001	2055160001	2046160001	2047160001
TERRA SENESE/ SENESE EARTH		2054170001	2055170001	2046170001	2047170001

N.B./P.N.: LUNGHEZZA MASSIMA VERSIONE CROMO = 2,00 m / MAXIMUM LENGTH CHROME VERSION = 2.00 m
TESTATE DI CHIUSURA NON INCLUSE / DEAD ENDS NOT INCLUDED

N.B./P.N.: POSSIBILITA' DI AVERE LA COVER PRISMATIZZATA / PRISMATIC COVER ON DEMAND

k40

led integrato

integrated led

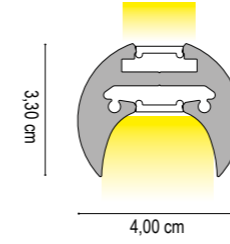

DATI TECNICI
TECHNICAL DATA

	1 cm - 48W/m	1 cm - 60W/m
Nominal LED Flux:	↑ 2880 lm/m - 2880 lm/m ↓	↑ 4440 lm/m - 4440 lm/m ↓
Flux Tot:	↑ 2460 lm/m - 2460 lm/m ↓	↑ 3552 lm/m - 3552 lm/m ↓
Output:	125 lm/W	148 lm/W
CCT:	3000 K	3000 K
CRI:	>95	>90
Power:	↑ 24.0W/m - 24.0W/m ↓	↑ 30.0W/m - 30.0W/m ↓
Power Tot:	48.0W/m	60.0W/m
Weight:	1.40 Kg/m	1.40 Kg/m

Alluminio/aluminium

Cover: Opale/opal - Satinato/Satin

DRIVER NON INCLUSO / NOT INCLUDED

CAVO ALIMENTAZIONE : 50 cm
ALIMENTATION CABLE : 50 cm

Lmax = 300cm

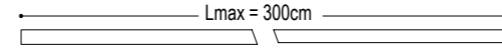

1 cm - 48W/m

1 cm - 60W/m

FINITURA STRUTTURA FINISHES	DIFFUSORE DIFFUSER	1 cm - 48W/m		1 cm - 60W/m	
		CODICE 2700K CODE 2700K	CODICE 3000K CODE 3000K	CODICE 2700K CODE 2700K	CODICE 3000K CODE 3000K
GRIGIO VESUVIO ANTHRACITE		20H6000001	20H7000001	2080000001	2081000001
ARGILLA CLAY		20H6010001	20H7010001	2080010001	2081010001
BIANCO INTONACO/WHITE		20H6030001	20H7030001	2080030001	2081030001
NERO CARAVAGGIO/BLACK		20H6040001	20H7040001	2080040001	2081040001
MOKA MOCHA		20H6050001	20H7050001	2080050001	2081050001
CROMO/CHROME		20H6080001	20H7080001	2080080001	2081080001
ORO CALIFORNIA/GOLD	SATINATA/SATIN	20H6090001	20H7090001	2080090001	2081090001
ARAMEN COPPER	OPALE/OPAL	20H6100001	20H7100001	2080100001	2081100001
GRIGIO AVIO/ GREY AVIO		20H6110001	20H7110001	2080110001	2081110001
OTTONE VENEZIANO/ VENETIAN BRASS		20H6130001	20H7130001	2080130001	2081130001
TITANIO/TITANIUM		20H6140001	20H7140001	2080140001	2081140001
BRONZO RIACI/RIACI BRONZE		20H6150001	20H7150001	2080150001	2081150001
VERDE COSTA/ GREEN COAST		20H6160001	20H7160001	2080160001	2081160001
TERRA SENESE/ SENESE EARTH		20H6170001	20H7170001	2080170001	2081170001

N.B./P.N.: LUNGHEZZA MASSIMA VERSIONE CROMO = 2,00 m / MAXIMUM LENGTH CHROME VERSION = 2.00 m
TESTATE DI CHIUSURA NON INCLUSE / DEAD ENDS NOT INCLUDED

N.B./P.N.: POSSIBILITA' DI AVERE LA COVER PRISMATIZZATA / PRISMATIC COVER ON DEMAND



TESTATE DI CHIUSURA / DEAD ENDS

FINITURA STRUTTURA FINISHES	CODICE CODE	FINITURA STRUTTURA FINISHES	CODICE CODE
GRIGIO VESUVIO ANTHRACITE	200400	GRIGIO AVIO GREY AVIO	200411
ARGILLA CLAY	200401	ARGENTO COMETA/SILVER COMET	200412
BIANCO INTONACO/WHITE	200403	OTTONE VENEZIANO BRASS	200413
NERO CARAVAGGIO BLACK	200404	TITANIO/TITANIUM	200414
MOKA MOCHA	200405	BRONZO RIACI/RIACI BRONZE	200415
CROMO CHROME	200408	VERDE COSTA/GREEN COAST	200416
ORO CALIFORNIA/GOLD	200409	TERRA SENESE SENESE EARTH	200417
ARAMEN COPPER	200410		

Il codice contiene 1 testata di chiusura con viti.
The code contains 1 closing warhead with screws.

DESCRIZIONE DESCRIPTION	FINITURA FINISHES	CODICE CODE
GIUNTO LINEA CONTINUA / STRAIGHT JOINT Accessorio per giunzioni meccaniche lineari Accessory for linear mechanical joints	ALLUMINIO NATURALE ALUMINUM	200606
GIUNTO 90° ORIZZONTALE / HORIZONTAL JOINT 90° Accessorio per giunzioni meccaniche con angolo 90° Accessory for linear mechanical joints with 90° angle	ALLUMINIO NATURALE ALUMINUM	200502

ATTACCO A PLAFONE / CEILING MOUNT

FINITURA STRUTTURA FINISHES	CODICE CODE	FINITURA STRUTTURA FINISHES	CODICE CODE
GRIGIO VESUVIO ANTHRACITE	200500	GRIGIO AVIO GREY AVIO	200511
ARGILLA CLAY	200501	ARGENTO COMETA/SILVER COMET	200512
BIANCO INTONACO/WHITE	200503	OTTONE VENEZIANO BRASS	200513
NERO CARAVAGGIO BLACK	200504	TITANIO/TITANIUM	200414
MOKA MOCHA	200505	BRONZO RIACI/RIACI BRONZE	200415
CROMO CHROME	200508	VERDE COSTA/GREEN COAST	200416
ORO CALIFORNIA/GOLD	200509	TERRA SENESE SENESE EARTH	200517
ARAMEN COPPER	200510		

KIT DI SOSPENSIONE / SUSPENSION KIT

ARTICOLI INCLUSI NEL CODICE ARTICOLI INCLUSI NEL CODICE Cavo in acciaio 2,00m con puntalino 2.00mm steel cable with tip	FINITURA FINISHES	CODICE CODE
Boccola cromata con regolazione millimetrica / Chromed bushing with millimetric adjustment Sistema di aggancio al modello / model hooking system	ALLUMINIO NATURALE ALUMINUM	200706

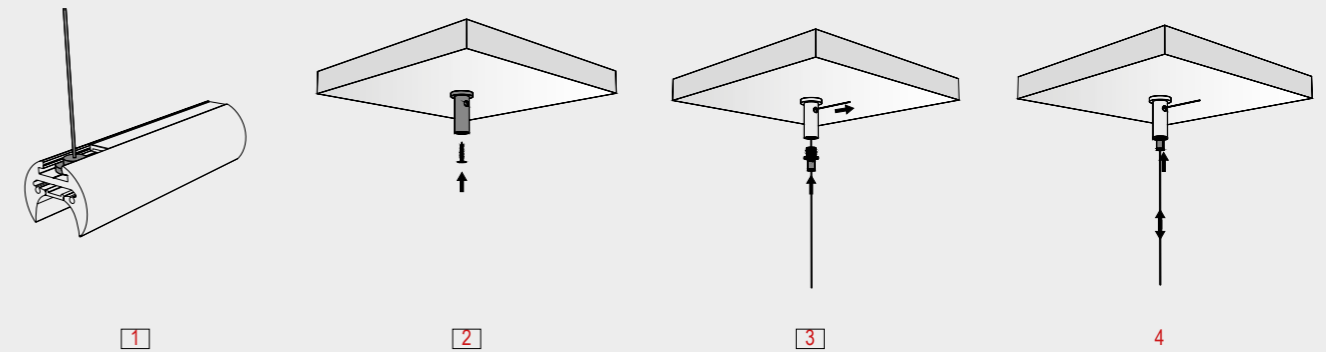
INSTALLAZIONE KIT DI SOSPENSIONE
SUSPENSION KIT INSTALLATION

1. IL PRODOTTO K40 VIENE FORNITO CON IL KIT DI SOSPENSIONE INSTALLATO SUL PROFILO.
THE K40 PRODUCT IS PROVIDED WITH THE SUSPENSION KIT INSTALLED ON THE PROFILE.
2. FISSARE LA BOCCOLA A SOFFITTO PER MEZZO DI TASSELLI IDONEI AL SUPPORTO MURARIO.
FIX THE CEILING BUSHING BY MEANS OF SUITABLE DOWELS TO THE WALL SUPPORT.
3. PREMERE LE DUE ESTREMITÀ DEL PERNO PER INSERIRE IL CAVO IN ACCIAIO FACENDOLO PASSARE NELLA BOCCOLA A SOFFITTO.
PRESS THE TWO PARTS OF THE PIN TO INSERT THE STEEL CABLE AND PASS IT INTO THE CEILING BUSHING.
4. AVVITARE IL PERNO ALLA BOCCOLA. PREMERE LA PARTE INFERIORE DEL PERNO PER REGOLARE LA LUNGHEZZA DEL CAVO.
SCREW THE PIN TO THE BUSH. PRESS THE LOWER PART OF THE PIN TO ADJUST THE CABLE LENGTH.

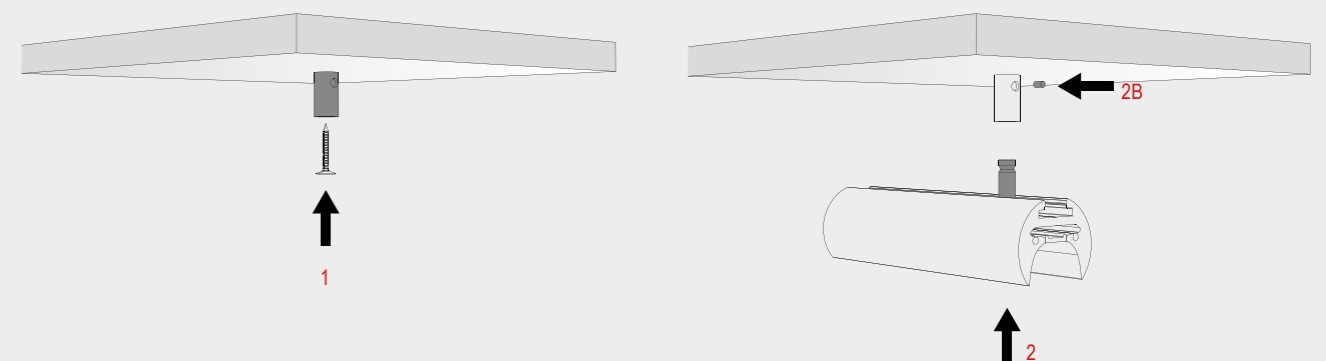
INSTALLAZIONE A SOFFITTO
CEILING INSTALLATION

1. FISSARE LA BOCCOLA A SOFFITTO PER MEZZO DI TASSELLI IDONEI AL TIPO DI SUPPORTO MURARIO.
FIX THE CEILING BUSHING BY MEANS OF DOWELS SUITABLE FOR THE TYPE OF WALL SUPPORT
2. INSERIRE IL PERNO (GIÀ FISSATO SUL PRODOTTO) NELLA BOCCOLA E (2B) BLOCCARLO CON L'APPOSITO GRANO FILETTATO.
INSERT THE PIN (ALREADY FIXED ON THE PRODUCT) IN THE BUSHING AND LOCK IT WITH THE APPROPRIATE THREADED WHEEL.

LAVORAZIONI / PROCESSING

DATI TECNICI TECHNICAL DATA	CODICE CODE
TAGLIO 90° ORIZZONTALE (PER ANGOLI FORMATI DA DUE PROFILI) HORIZONTAL 90° CUT (FOR CORNERS MADE OF TWO PROFILES)	190X
ASOLA / SLOT	100A
ASOLA CUSTOM / SLOT CUSTOM	100N
FORO / HOLE	100F

“a più alta efficienza energetica”

La nuova famiglia K è il risultato di lavoro duro, dedizione, talento, entusiasmo e passione che ogni persona nella nostra azienda ha messo in questo straordinario progetto, permettendoci di presentare a tutta la nostra clientela nazionale ed internazionale profili evoluti. Design Luce è stata la prima azienda italiana a proporre una gamma con elevate prestazioni, personalità, bellezza e qualità tipiche del made in Italy. K25 è stato pensato per integrare al suo interno elementi ottici, consentendoci di ottenere basse luminanze e impiegare al meglio sorgenti luminose a led di ultima generazione con elevati CRI fino a 95 e con la più alta efficienza energetica (fino a 150lm/W).

La gamma di finiture, la personalizzazione del progetto, caratteristica ormai consolidate della nostra azienda, rendono questa famiglia uno strumento indispensabile per il progettista.

The new range of “K” products is the outcome of hard work, dedication, talent, enthusiasm and passion that the staff of Design Luce dedicated to this extraordinary project. Design Luce is now the first Italian company able to offer advanced aluminum lighting profiles with high performance, personality, beauty and quality typical of Made in Italy.

K25 is designed to integrate excellent optical and thermal elements to allowing to use at the best the performance of the last generations of LED light sources with CRI up to 95 and the highest energy efficiency (up to 150 lm/W). The range of finishes, the customization of the project, a well established feature of our company, make this family an indispensable tool for designers and architects.



k25

k25

configurazioni

configurations

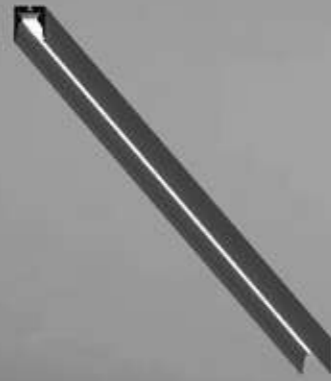

È POSSIBILE RICHIEDERE LA REALIZZAZIONE DI COMPOSIZIONI ANGOLARI CON ANGOLO DI AMPIEZZA DIVERSA DA 90°.
OGNI RICHIESTA DEVE PERVENIRE AL NOSTRO UFFICIO TECNICO CORREDATA DA PROGETTO.
IT IS POSSIBLE TO REQUEST THE CREATION OF ANGULAR COMPOSITIONS WITH AN ANGLE OF DIFFERENT 90°.
EVERY REQUEST MUST COME TO OUR TECHNICAL OFFICE WITH PROJECT.

LE CONFIGURAZIONI SOPRA RIPORTATE SONO COMPATIBILI PER LA VERSIONE CON DIFFUSORE RECESSO E PER LA VERSIONE CON DIFFUSORE ESTERNO.
THE CONFIGURATIONS SHOWN ABOVE ARE COMPATIBLE FOR THE VERSION WITH RECESSED DIFFUSER AND FOR THE VERSION WITH EXTERNAL SPEAKER.

INSTALLAZIONE A SOSPENSIONE
SUSPENSION

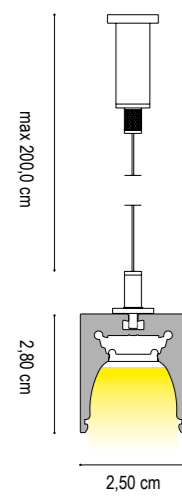

INSTALLAZIONE CON CLIP IN POLICARBONATO SU SUPERFICIE ORIZZONTALE
INSTALLATION WITH POLYCARBONATE CLIP ON HORIZONTAL SURFACE

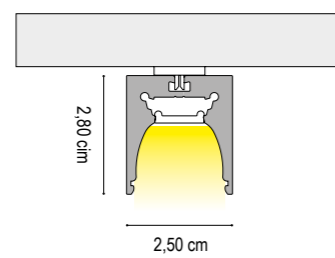

INSTALLAZIONE CON STAFFA MAGNETICA SU SUPERFICIE METALLICA ORIZZONTALE
INSTALLATION WITH MAGNET ON HORIZONTAL METAL SURFACE

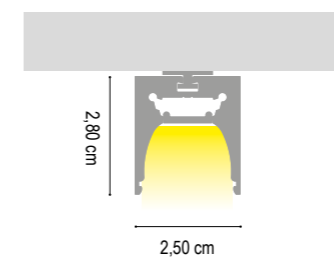

SI RACCOMANDA L'UTILIZZO DI N° 1 STAFFA MAGNETICA OGNI 25,00 cm DI PROFILO. TALE QUANTITÀ PUÒ VARIARE A SECONDA DELLA SUPERFICIE METALLICA DI INSTALLAZIONE.

WE RECOMMEND THE USE OF N° 1 MAGNETIC BRACKET EVERY 25.00 cm OF PROFILE. THIS QUANTITY MAY VARY DEPENDING ON THE METAL INSTALLATION SURFACE.

INSTALLAZIONE A PARETE
WALL INSTALLATION

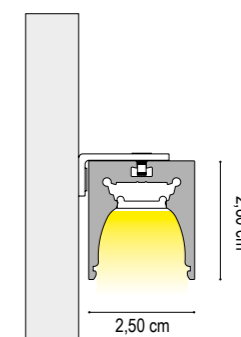

DATI TECNICI
TECHNICAL DATA

DIFFUSORE RECESSO / RECESSED DIFFUSER

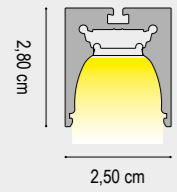

	1 cm - 20W/m		1 cm - 24W/m	
Nominal LED Flux:	2100 lm/m	2200 lm/m	2850 lm/m	3000 lm/m
Flux Tot:	1680 lm/m	1760 lm/m	2700 lm/m	2460 lm/m
Output:	105 lm/W	110 lm/W	120 lm/W	125 lm/W
CCT:	2700 K	3000 K	2700 K	3000 K
CRI:	>90	>90	>95	>95
Power Tot:	20.0W/m	20.0W/m	24.0W/m	24.0W/m
Weight:	0.30 Kg/m	0.30 Kg/m	0.30 Kg/m	0.30 Kg/m

Alluminio/aluminium

Cover: Opale/opal

Lmax = 300cm

DRIVER NON INCLUSO / NOT INCLUDED

CAVO ALIMENTAZIONE : 50 cm
ALIMENTATION CABLE : 50 cm

FINITURA STRUTTURA
FINISHES

- GRIGIO VESUVIO ANTHRACITE
- ARGILLA CLAY
- BIANCO INTONACO/WHITE
- NERO CARAVAGGIO/BLACK
- MOKA MOCHA
- CROMO/CHROME
- ORO CALIFORNIA/GOLD
- ARAMEN COPPER
- GRIGIO AVIO/ GREY AVIO
- OTTONE VENEZIANO/ VENETIAN BRASS
- TITANIO/TITANIUM
- BRONZO RIACI/RIACI BRONZE
- VERDE COSTA/GREEN COAST
- TERRA SENESE SENESE EARTH

DIFFUSORE
DIFFUSER

- SATINATA/SATIN
- OPALE/OPAL

	1 cm - 2700K	1 cm - 3000K	1 cm - 2700K	1 cm - 3000K
CODICE CODE	252500001	252600001	25H600001	25H700001
CODICE CODE	252501001	252601001	25H601001	25H701001
CODICE CODE	252503001	252603001	25H603001	25H703001
CODICE CODE	252504001	252604001	25H604001	25H704001
CODICE CODE	252505001	252605001	25H605001	25H705001
CODICE CODE	252508001	252608001	25H608001	25H708001
CODICE CODE	252509001	252609001	25H609001	25H709001
CODICE CODE	252510001	252610001	25H610001	25H710001
CODICE CODE	252511001	252611001	25H611001	25H711001
CODICE CODE	252513001	252613001	25H613001	25H713001
CODICE CODE	252514001	252614001	25H614001	25H714001
CODICE CODE	252515001	252615001	25H615001	25H715001
CODICE CODE	252516001	252616001	25H616001	25H716001
CODICE CODE	252517001	252617001	25H617001	25H717001

N.B./P.N.: LUNGHEZZA MASSIMA VERSIONE CROMO = 2,00 m / MAXIMUM LENGTH CHROME VERSION = 2.00 m
TESTATE DI CHIUSURA NON INCLUSE / DEAD ENDS NOT INCLUDED

N.B./P.N.: POSSIBILITA' DI AVERE LA COVER PRISMATIZZATA / PRISMATIC COVER ON DEMAND

DATI TECNICI
TECHNICAL DATA

DIFFUSORE ESTERNO / EXTERNAL DIFFUSER

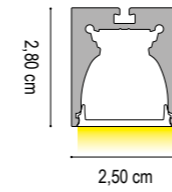

	1 cm - 20W/m		1 cm - 24W/m	
Nominal LED Flux:	2100 lm/m	2200 lm/m	2850 lm/m	3000 lm/m
Flux Tot:	1680 lm/m	1760 lm/m	2700 lm/m	2460 lm/m
Output:	105 lm/W	110 lm/W	120 lm/W	125 lm/W
CCT:	2700 K	3000 K	2700 K	3000 K
CRI:	>90	>90	>95	>95
Power Tot:	20.0W/m	20.0W/m	24.0W/m	24.0W/m
Weight:	0.30 Kg/m	0.30 Kg/m	0.30 Kg/m	0.30 Kg/m

Lmax = 300cm

DRIVER NON INCLUSO / NOT INCLUDED

CAVO ALIMENTAZIONE : 50 cm
ALIMENTATION CABLE : 50 cm

FINITURA STRUTTURA
FINISHES

- GRIGIO VESUVIO ANTHRACITE
- ARGILLA CLAY
- BIANCO INTONACO/WHITE
- NERO CARAVAGGIO/BLACK
- MOKA MOCHA
- CROMO/CHROME
- ORO CALIFORNIA/GOLD
- ARAMEN COPPER
- GRIGIO AVIO/ GREY AVIO
- OTTONE VENEZIANO/ VENETIAN BRASS
- TITANIO/TITANIUM
- BRONZO RIACI/RIACI BRONZE
- VERDE COSTA/GREEN COAST
- TERRA SENESE SENESE EARTH

DIFFUSORE
DIFFUSER

- SATINATA/SATIN
- OPALE/OPAL

	1 cm - 2700K	1 cm - 3000K	1 cm - 2700K	1 cm - 3000K
CODICE CODE	2525001001	2526001001	25H6001001	25H7001001
CODICE CODE	2525011001	2526011001	25H6011001	25H7011001
CODICE CODE	2525031001	2526031001	25H6031001	25H7031001
CODICE CODE	2525041001	2526041001	25H6041001	25H7041001
CODICE CODE	2525051001	2526051001	25H6051001	25H7051001
CODICE CODE	2525081001	2526081001	25H6081001	25H7081001
CODICE CODE	2525091001	2526091001	25H6091001	25H7091001
CODICE CODE	2525101001	2526101001	25H6101001	25H7101001
CODICE CODE	2525111001	2526111001	25H6111001	25H7111001
CODICE CODE	2525131001	2526131001	25H6131001	25H7131001
CODICE CODE	2525141001	2526141001	25H6141001	25H7141001
CODICE CODE	2525151001	2526151001	25H6151001	25H7151001
CODICE CODE	2525161001	2526161001	25H6161001	25H7161001
CODICE CODE	2525171001	2526171001	25H6171001	25H7171001

N.B./P.N.: LUNGHEZZA MASSIMA VERSIONE CROMO = 2,00 m / MAXIMUM LENGTH CHROME VERSION = 2.00 m
TESTATE DI CHIUSURA NON INCLUSE / DEAD ENDS NOT INCLUDED

N.B./P.N.: POSSIBILITA' DI AVERE LA COVER PRISMATIZZATA / PRISMATIC COVER ON DEMAND

DATI TECNICI
TECHNICAL DATA

DIFFUSORE RECESSO / RECESSED DIFFUSER

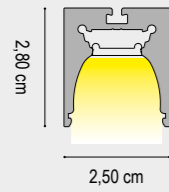

	1 cm - 30 W/m		
Nominal LED Flux:	2090 lm/m	3900 lm/m	2315 lm/m
Flux Tot:	1670 lm/m	1760 lm/m	1850 lm/m
Output:	110 lm/W	130 lm/W	110 lm/W
CCT:	2700 K	3000 K	4000 K
CRI:	>90	>90	>90
Power Tot:	30.0W/m	30.0W/m	30.0W/m
Weight:	0.30 Kg/m	0.30 Kg/m	0.30 Kg/m

Alluminio/aluminium

Cover: Opale/opal

Lmax = 300cm

DRIVER NON INCLUSO / NOT INCLUDED

CAVO ALIMENTAZIONE : 50 cm
ALIMENTATION CABLE : 50 cmFINITURA STRUTTURA
FINISHES

GRIGIO VESUVIO ANTHRACITE
ARGILLA CLAY
BIANCO INTONACO/WHITE
NERO CARAVAGGIO BLACK
MOKA MOCHA
CROMO/CHROME
ORO CALIFORNIA/GOLD
ARAMEN COPPER
GRIGIO AVIO/GREY AVIO
OTTONE VENEZIANO VENETIAN BRASS
TITANIO/TITANIUM
BRONZO RIACI/RIACI BRONZE
VERDE COSTA/GREEN COAST
TERRA SENESE SENESE EARTH
ARANCIO RIBERA ORANGE RIBERA

DIFFUSORE
DIFFUSERSATINATA/SATIN
OPALE/OPAL

	1 cm - 2700K	1 cm - 3000K	1 cm - 4000K
CODICE CODE	CODICE CODE	CODICE CODE	CODICE CODE
2580000001	2581000001	2582000001	
2580010001	2581010001	2582010001	
2580030001	2581030001	2582030001	
2580040001	2581040001	2582040001	
2580050001	2581050001	2582050001	
2580080001	2581080001	2582080001	
2580090001	2581090001	2582090001	
2580100001	2581100001	2582100001	
2580110001	2581110001	2582110001	
2580130001	2581130001	2582130001	
2580140001	2581140001	2582140001	
2580150001	2581150001	2582150001	
2580160001	2581160001	2582160001	
2580170001	2581170001	2582170001	
2580180001	2581180001	2582180001	

N.B./P.N.: LUNGHEZZA MASSIMA VERSIONE CROMO = 2,00 m / MAXIMUM LENGTH CHROME VERSION = 2.00 m
TESTATE DI CHIUSURA NON INCLUSE / DEAD ENDS NOT INCLUDED

N.B./P.N.: POSSIBILITA' DI AVERE LA COVER PRISMATIZZATA / PRISMATIC COVER ON DEMAND

DATI TECNICI
TECHNICAL DATA

DIFFUSORE ESTERNO / EXTERNAL DIFFUSER

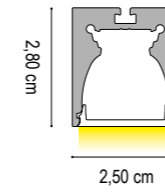

	1 cm - 30W/m		
Nominal LED Flux:	2090 lm/m	2200 lm/m	2315 lm/m
Flux Tot:	1670 lm/m	1760 lm/m	1850 lm/m
Output:	110 lm/W	110 lm/W	110 lm/W
CCT:	2700 K	3000 K	4000 K
CRI:	>90	>90	>90
Power Tot:	30.0W/m	30.0W/m	30.0W/m
Weight:	0.30 Kg/m	0.30 Kg/m	0.30 Kg/m

Alluminio/aluminium

Cover: Opale/opal

Lmax = 300cm

DRIVER NON INCLUSO / NOT INCLUDED

CAVO ALIMENTAZIONE : 50 cm
ALIMENTATION CABLE : 50 cmFINITURA STRUTTURA
FINISHES

GRIGIO VESUVIO ANTHRACITE
ARGILLA CLAY
BIANCO INTONACO/WHITE
NERO CARAVAGGIO BLACK
MOKA MOCHA
CROMO/CHROME
ORO CALIFORNIA/GOLD
ARAMEN COPPER
GRIGIO AVIO/GREY AVIO
OTTONE VENEZIANO VENETIAN BRASS
TITANIO/TITANIUM
BRONZO RIACI/RIACI BRONZE
VERDE COSTA/GREEN COAST
TERRA SENESE SENESE EARTH
ARANCIO RIBERA ORANGE RIBERA

DIFFUSORE
DIFFUSERSATINATA/SATIN
OPALE/OPAL

	1 cm - 2700K	1 cm - 3000K	1 cm - 4000K
CODICE CODE	CODICE CODE	CODICE CODE	CODICE CODE
2580001001	2581001001	2582001001	
2580011001	2581011001	2582011001	
2580031001	2581031001	2582031001	
2580041001	2581041001	2582041001	
2580051001	2581051001	2582051001	
2580081001	2581081001	2582081001	
2580091001	2581091001	2582091001	
2580101001	2581101001	2582101001	
2580111001	2581111001	2582111001	
2580131001	2581131001	2582131001	
2580141001	2581141001	2582141001	
2580151001	2581151001	2582151001	
2580161001	2581161001	2582161001	
2580171001	2581171001	2582171001	
2580181001	2581181001	2582181001	

N.B./P.N.: LUNGHEZZA MASSIMA VERSIONE CROMO = 2,00 m / MAXIMUM LENGTH CHROME VERSION = 2.00 m
TESTATE DI CHIUSURA NON INCLUSE / DEAD ENDS NOT INCLUDED

N.B./P.N.: POSSIBILITA' DI AVERE LA COVER PRISMATIZZATA / PRISMATIC COVER ON DEMAND

TESTATE DI CHIUSURA / DEAD ENDS

FINITURA STRUTTURA FINISHES	CODICE CODE	FINITURA STRUTTURA FINISHES	CODICE CODE
GRIGIO VESUVIO ANTHRACITE	250400	GRIGIO AVIO / GREY AVIO	250411
ARGILLA CLAY	250401	ARGENTO COMETA / SILVER COMET	250412
BIANCO INTONACO / WHITE	250403	OTTONE VENEZIANO / BRASS	250413
NERO CARAVAGGIO BLACK	250404	TITANIO / TITANIUM	250414
MOKA MOCHA	250405	BRONZO RIACI / RIACI BRONZE	250415
CROMO / CHROME	250408	VERDE COSTA / GREEN COAST	250416
ORO CALIFORNIA / GOLD	250409	TERRA SENESE / SENESE EARTH	250417
ARAMEN COPPER	250410	ARANCIO RIBERA / ORANGE RIBERA	250418

Il codice contiene 1 testata di chiusura con viti.
The code contains 1 closing warhead with screws.

STAFFA DI FISSAGGIO A DOPPIO ATTACCO / DOUBLE MOUNTING CLIP CALAMITA / MAGNET

FINITURA FINISHES	CODICE CODE	CODICE CODE	PORTATA RANGE
SUPERFICI PIANE 2mm EVEN SURFACE 2mm	102050005	1020500010	1 Kg
SUPERFICI IRREGOLARI 3,9mm UNEVEN SURFACE 3,9mm	102050006	1020500210	2 Kg

Accessorio per fissaggio a plafone/superficie. Quantità raccomandata: 1 pz ogni 50 cm di modello.

Ceiling/surface mounting accessory. Recommended quantity 1 pc every 50 cm of model.

Quantità raccomandata: 1 pz ogni 25 cm di modello.

Recommended quantity: 1 pc every 25 cm of model.

GIUNTI / JOINTS

GIUNTO LINEA CONTINUA / STRAIGHT JOINT	FINITURA FINISHES	CODICE CODE
Accessorio per giunzioni meccaniche lineari Accessory for linear mechanical joints	ALLUMINIO NATURALE / ALUMINUM	1010500006
GIUNTO 90° ORIZZONTALE / HORIZONTAL JOINT 90°	ALLUMINIO NATURALE / ALUMINUM	1010500005
Accessorio per giunzioni meccaniche con angolo 90° Accessory for linear mechanical joints with 90° angle		
GIUNTO 90° VERTICALE / VERTICAL JOINT 90°	ALLUMINIO NATURALE / ALUMINUM	1010500007
Accessorio per giunzioni meccaniche con angolo 90° Accessory for linear mechanical joints with 90° angle		

Il codice contiene i grani per il fissaggio del giunto.
The code contains the grains to fix the joint.

STAFFA DI FISSAGGIO A PARETE / WALL MOUNTING CLIP

DATI TECNICI
TECHNICAL DATA

MATERIALE: Alluminio naturale
MATERIAL: Natural aluminium

Nel codice è compresa la vite per il fissaggio della staffa al modello
The code includes the screw for fixing the bracket to the model

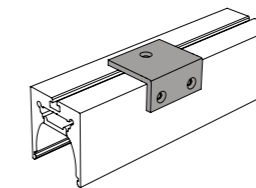

FINITURA STRUTTURA FINISHES

CODICE CODE

GRIGIO VESUVIO ANTHRACITE	1030500003
ARGILLA CLAY	1030501003
BIANCO INTONACO / WHITE	1030503003
NERO CARAVAGGIO BLACK	1030504003
MOKA MOCHA	1030505003
CROMO / CHROME	1030508003
ORO CALIFORNIA / GOLD	1030509003
ARAMEN COPPER	1030510003
ARGENTO COMETA / SILVER COMET	1030512003
OTTONE VENEZIANO / VENETIAN BRASS	1030513003
TITANIO / TITANIUM	1030514003
BRONZO RIACI / RIACI BRONZE	1030515003
VERDE COSTA / GREEN COAST	1030516003
TERRA SENESE / SENESE EARTH	1030517003
ARANCIO RIBERA / ORANGE RIBERA	1030518003

KIT DI SOSPENSIONE / SUSPENSION KIT

DATI TECNICI
TECHNICAL DATA

ARTICOLI INCLUSI NEL CODICE
ARTICLES INCLUDED IN THE CODE

Cavo in acciaio 2,00m con puntalino
2.00m steel cable with tip
Boccola cromata con regolazione millimetrica
Chrome bush with millimeter adjustment
Archetto in alluminio per sospensione
Aluminum arch for suspension

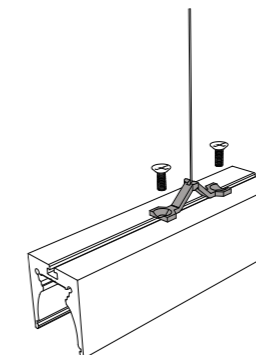

FINITURA STRUTTURA FINISHES

CODICE CODE

GRIGIO VESUVIO ANTHRACITE	1040500004
ARGILLA CLAY	1040501004
BIANCO INTONACO / WHITE	1040503004
NERO CARAVAGGIO BLACK	1040504004
MOKA MOCHA	1040505004
CROMO / CHROME	1040508004
ORO CALIFORNIA / GOLD	1040509004
ARAMEN COPPER	1040510004
ARGENTO COMETA / SILVER COMET	1040512004
OTTONE VENEZIANO / VENETIAN BRASS	1040513004
TITANIO / TITANIUM	1040514004
BRONZO RIACI / RIACI BRONZE	1040515004
VERDE COSTA / GREEN COAST	1040516004
TERRA SENESE / SENESE EARTH	1040517004
ARANCIO RIBERA / ORANGE RIBERA	1040518004

LAVORAZIONI / PROCESSING

DATI TECNICI
TECHNICAL DATA

TAGLIO 90° ORIZZONTALE (PER ANGOLI FORMATI DA DUE PROFILI)
HORIZONTAL 90° CUT (FOR CORNERS MADE OF TWO PROFILES)
TAGLIO 90° VERTICALE (PER ANGOLI FORMATI DA DUE PROFILI)
VERTICAL 90° CUT (FOR CORNERS MADE OF TWO PROFILES)
TAGLIO ANGOLARE CUSTOM (PER ANGOLI FORMATI DA DUE PROFILI)
CUSTOM CORNER CUT (FOR CORNERS MADE OF TWO PROFILES)
ASOLA / SLOT
ASOLA CUSTOM / SLOT CUSTOM



FORO / HOLE

CABLAGGIO CE

CODICE CODE

190X
190Y
190N
100A
100N
100F
2501

“fascio di luce diretto e concentrato”

K15 è il profilo più piccolo della famiglia K di Design Luce. Coniuga in un design unico e minimale tutta la nostra esperienza nel settore delle ottiche e dell'illuminazione con sorgenti LED.

È realizzato in alluminio estruso e verniciato nelle finiture proposte. Genera un fascio di luce diretto e concentrato grazie alla posizione arretrata delle ottiche.

K15 is the smallest profile in the K family of Design Luce. It combines in a unique and minimal design all our experience in the field of optics and lighting with LED sources. It is made of extruded aluminum and painted in the proposed finishes. It generates a direct and concentrated light beam thanks to the rearward position of the optics.



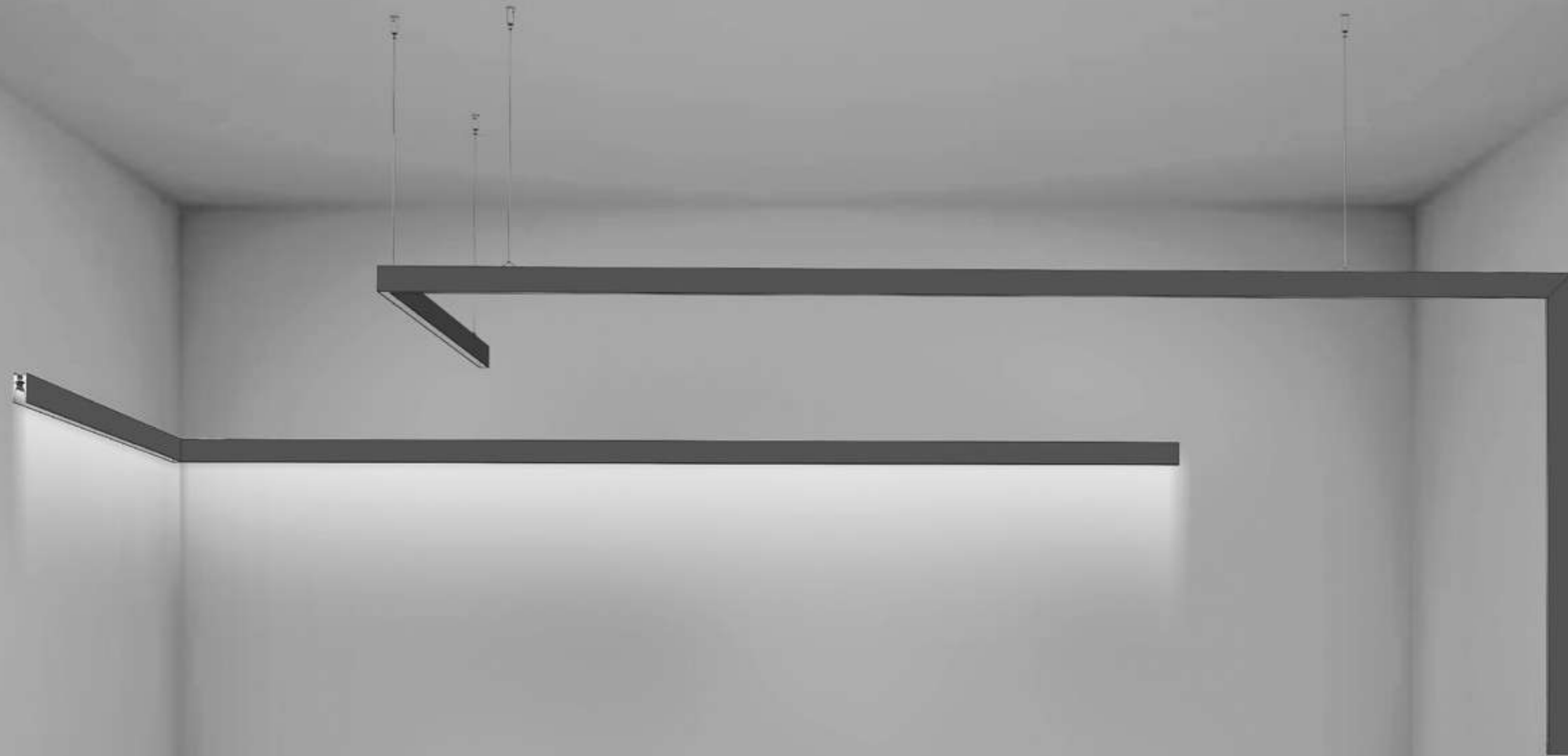

È POSSIBILE RICHIEDERE LA REALIZZAZIONE DI COMPOSIZIONI ANGOLARI CON ANGOLO DI AMPIEZZA DIVERSA DA 90°.
OGNI RICHIESTA DEVE PERVENIRE AL NOSTRO UFFICIO TECNICO CORREDATA DA PROGETTO.

IT IS POSSIBLE TO REQUEST THE CREATION OF ANGULAR COMPOSITIONS WITH AN ANGLE OF DIFFERENT 90 °.
EVERY REQUEST MUST COME TO OUR TECHNICAL OFFICE WITH PROJECT.

LE CONFIGURAZIONI SOPRA RIPORTATE SONO COMPATIBILI PER LA VERSIONE CON DIFFUSORE RECESSO E PER LA VERSIONE CON DIFFUSORE ESTERNO.
THE CONFIGURATIONS SHOWN ABOVE ARE COMPATIBLE FOR THE VERSION WITH RECESSED DIFFUSER AND FOR THE VERSION WITH EXTERNAL SPEAKER.

INSTALLAZIONE A SOSPENSIONE
SUSPENSION

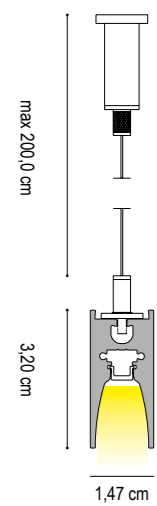

INSTALLAZIONE CON CLIP IN POLICARBONATO SU SUPERFICIE ORIZZONTALE
INSTALLATION WITH POLYCARBONATE CLIP ON HORIZONTAL SURFACE

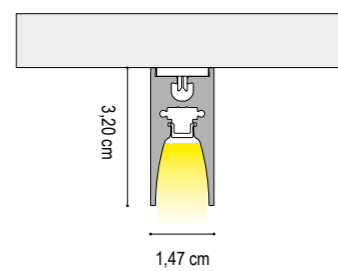

INSTALLAZIONE CON STAFFA MAGNETICA SU SUPERFICIE METALLICA ORIZZONTALE
INSTALLATION WITH MAGNET ON HORIZONTAL METAL SURFACE

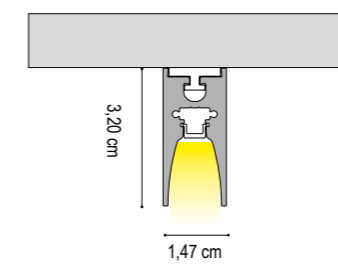

SI RACCOMANDA L'UTILIZZO DI N° 1 STAFFA MAGNETICA OGNI 25,00 cm DI PROFILO. TALE QUANTITÀ PUÒ VARIARE A SECONDA DELLA SUPERFICIE METALLICA DI INSTALLAZIONE.

WE RECOMMEND THE USE OF N° 1 MAGNETIC BRACKET EVERY 25,00 cm OF PROFILE. THIS QUANTITY MAY VARY DEPENDING ON THE METAL INSTALLATION SURFACE.

INSTALLAZIONE A PARETE
WALL INSTALLATION

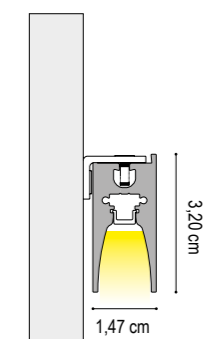

DATI TECNICI
TECHNICAL DATA

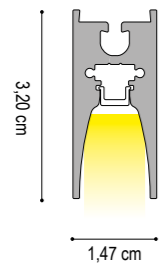

1 cm - 12W/m			
Nominal LED Flux:	1805 lm/m	1900 lm/m	2000 lm/m
Flux Tot:	1440 lm/m	1520 lm/m	1600 lm/m
Output:	150 lm/W	158 lm/W	166 lm/W
CCT:	2700 K	3000 K	4000 K
CRI:	>90	>90	>90
Power Tot:	12.0W/m	12.0W/m	12.0W/m
Weight:	0.20 Kg/m	0.20 Kg/m	0.20 Kg/m

Alluminio/aluminium

Cover: Opale/opal

Lmax = 300cm

DRIVER NON INCLUSO / NOT INCLUDED

CAVO ALIMENTAZIONE : 50 cm
ALIMENTATION CABLE : 50 cm

DATI TECNICI
TECHNICAL DATA

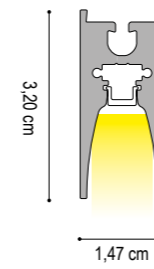

1 cm - 12W/m			
Nominal LED Flux:	1530 lm/m	1610 lm/m	1690 lm/m
Flux Tot:	1225 lm/m	1288 lm/m	1355 lm/m
Output:	128 lm/W	134 lm/W	140 lm/W
CCT:	2700 K	3000 K	4000 K
CRI:	>97 - R9>90	>97 - R9>90	>97 - R9>90
Power Tot:	12.0W/m	12.0W/m	12.0W/m
Weight:	0.20 Kg/m	0.20 Kg/m	0.20 Kg/m

Alluminio/aluminium

Cover: Opale/opal

Lmax = 300cm

DRIVER NON INCLUSO / NOT INCLUDED

CAVO ALIMENTAZIONE : 50 cm
ALIMENTATION CABLE : 50 cm

1 cm - 2700K 1 cm - 3000K 1 cm - 4000K

FINITURA STRUTTURA
FINISHES

- GRIGIO VESUVIO ANTHRACITE
- ARGILLA CLAY
- ARGENTO OPACO MATT SILVER
- BIANCO INTONACO/WHITE
- NERO CARAVAGGIO BLACK
- MOKA MOCHA
- CROMO/CHROME
- ORO CALIFORNIA/GOLD
- ARAMEN COPPER
- ARGENTO COMETA/SILVER COMET
- OTTONE VENEZIANO/VENETIAN BRASS
- TITANIO/TITANIUM
- BRONZO RIACI/RIACI BRONZE
- VERDE COSTA/GREEN COAST
- TERRA SENESE SENESE EARTH

DIFFUSORE
DIFFUSER

OPALE/OPAL

CODICE CODE	CODICE CODE	CODICE CODE
155400001	155500001	155600001
155401001	155501001	155601001
155402001	155502001	155602001
155403001	155503001	155603001
155404001	155504001	155604001
155405001	155505001	155605001
155408001	155508001	155608001
155409001	155509001	155609001
155410001	155510001	155610001
155412001	155512001	155612001
155413001	155513001	155613001
155414001	155514001	155614001
155415001	155515001	155615001
155416001	155516001	155616001
155417001	155517001	155617001

FINITURA STRUTTURA
FINISHES

- GRIGIO VESUVIO ANTHRACITE
- ARGILLA CLAY
- ARGENTO OPACO MATT SILVER
- BIANCO INTONACO/WHITE
- NERO CARAVAGGIO BLACK
- MOKA MOCHA
- CROMO/CHROME
- ORO CALIFORNIA/GOLD
- ARAMEN COPPER
- ARGENTO COMETA/SILVER COMET
- OTTONE VENEZIANO/VENETIAN BRASS
- TITANIO/TITANIUM
- BRONZO RIACI/RIACI BRONZE
- VERDE COSTA/GREEN COAST
- TERRA SENESE SENESE EARTH

DIFFUSORE
DIFFUSER

OPALE/OPAL

1 cm - 2700K 1 cm - 3000K 1 cm - 4000K

CODICE CODE	CODICE CODE	CODICE CODE
159600001	159700001	159800001
159601001	159701001	159801001
159602001	159702001	159802001
159603001	159703001	159803001
159604001	159704001	159804001
159605001	159705001	159805001
159608001	159708001	159808001
159609001	159709001	159809001
159610001	159710001	159810001
159612001	159712001	159812001
159613001	159713001	159813001
159614001	159714001	159814001
159615001	159715001	159815001
159616001	159716001	159816001
159617001	159717001	159817001

N.B./P.N.: LUNGHEZZA MASSIMA VERSIONE CROMO = 2,00 m / MAXIMUM LENGTH CHROME VERSION = 2.00 m
TESTATE DI CHIUSURA NON INCLUSE / DEAD ENDS NOT INCLUDED

N.B./P.N.: LUNGHEZZA MASSIMA VERSIONE CROMO = 2,00 m / MAXIMUM LENGTH CHROME VERSION = 2.00 m
TESTATE DI CHIUSURA NON INCLUSE / DEAD ENDS NOT INCLUDED

TESTATE DI CHIUSURA / DEAD ENDS

FINITURA STRUTTURA FINISHES	CODICE CODE	FINITURA STRUTTURA FINISHES	CODICE CODE
GRIGIO VESUVIO ANTHRACITE	150400	ARAMEN COPPER	150410
ARGILLA CLAY	150401	ARGENTO COMETA/SILVER COMET	150412
ARGENTO OPACO MATT SILVER	150402	OTTONE VENEZIANO BRASS	150413
BIANCO INTONACO/WHITE	150403	TITANIO/TITANIUM	150414
NERO CARAVAGGIO BLACK	150404	BRONZO RIACI/RIACI BRONZE	150415
MOKA MOCHA	150405	VERDE COSTA/GREEN COAST	150416
CROMO CHROME	150408	TERRA SENESE SENESE EARTH	150417
ORO CALIFORNIA/GOLD	150409		

Il codice contiene 1 testata di chiusura con viti.
The code contains 1 closing warhead with screws.

STAFFA DI FISSAGGIO A DOPPIO ATTACCO / DOUBLE MOUNTING CLIP CALAMITA / MAGNET

FINITURA FINISHES	CODICE CODE	CODICE CODE	PORTATA RANGE
SUPERFICI PIANE 2mm EVEN SURFACE 2mm	1020500005	1020500010	1 Kg
SUPERFICI IRREGOLARI 3,9mm UNEVEN SURFACE 3,9mm	1020500006	1020500210	2 Kg

Accessorio per fissaggio a plafone/superficie. Quantità raccomandata: 1 pz ogni 50 cm di modello.

Ceiling/surface mounting accessory. Recommended quantity 1 pc every 50 cm of model.

Quantità raccomandata: 1 pz ogni 25 cm di modello.

Recommended quantity: 1 pc every 25 cm of model.

GIUNTI / JOINTS

	FINITURA FINISHES	CODICE CODE
GIUNTO LINEA CONTINUA / STRAIGHT JOINT Accessorio per giunzioni meccaniche lineari Accessory for linear mechanical joints	ALLUMINIO NATURALE/ALUMINUM	1010500006
GIUNTO 90° ORIZZONTALE / HORIZONTAL JOINT 90° Accessorio per giunzioni meccaniche con angolo 90° Accessory for linear mechanical joints with 90° angle	ALLUMINIO NATURALE/ALUMINUM	1010500005
GIUNTO 90° VERTICALE / VERTICAL JOINT 90° Accessorio per giunzioni meccaniche con angolo 90° Accessory for linear mechanical joints with 90° angle	ALLUMINIO NATURALE/ALUMINUM	1010500007

Il codice contiene i grani per il fissaggio del giunto.
The code contains the grains to fix the joint.

STAFFA DI FISSAGGIO A PARETE / WALL MOUNTING CLIP

DATI TECNICI
TECHNICAL DATA

MATERIALE: Alluminio naturale
MATERIAL: Natural aluminum

Il codice comprende n°2 staffe con asole.
The code includes n°2 wall brackets with holes.

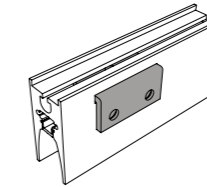
FINITURA STRUTTURA
FINISHESCODICE
CODE

ALLUMINIO NATURALE/ALUMINUM

150506A

KIT DI SOSPENSIONE / SUSPENSION KIT

DATI TECNICI
TECHNICAL DATA

ARTICOLI INCLUSI NEL CODICE
ARTICLES INCLUDED IN THE CODE

Cavo in acciaio 2,00m con puntalino
2.00m steel cable with tip
Boccola cromata con regolazione millimetrica
Chrome bush with millimeter adjustment
Archetto in alluminio per sospensione
Aluminum arch for suspension

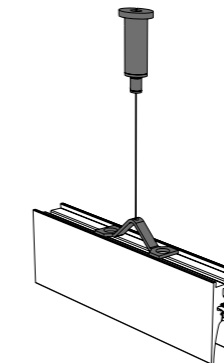
FINITURA STRUTTURA
FINISHESCODICE
CODE

GRIGIO VESUVIO ANTHRACITE

1040500004

ARGILLA CLAY

1040501004

BIANCO INTONACO/WHITE

1040503004

NERO CARAVAGGIO BLACK

1040504004

MOKA MOCHA

1040505004

CROMO CHROME

1040508004

ORO CALIFORNIA/GOLD

1040509004

ARAMEN COPPER

1040510004

ARGENTO COMETA/SILVER COMET

1040512004

OTTONE VENEZIANO VENETIAN BRASS

1040513004

TITANIO/TITANIUM

1040514004

BRONZO RIACI/RIACI BRONZE

1040515004

VERDE COSTA/GREEN COAST

1040516004

TERRA SENESE SENESE EARTH

1040517004

LAVORAZIONI / PROCESSING

DATI TECNICI
TECHNICAL DATA

TAGLIO 90° ORIZZONTALE (PER ANGOLI FORMATI DA DUE PROFILI)
HORIZONTAL 90° CUT (FOR CORNERS MADE OF TWO PROFILES)

190X

TAGLIO 90° VERTICALE (PER ANGOLI FORMATI DA DUE PROFILI)
VERTICAL 90° CUT (FOR CORNERS MADE OF TWO PROFILES)

190Y

TAGLIO ANGOLARE CUSTOM (PER ANGOLI FORMATI DA DUE PROFILI)
CUSTOM CORNER CUT (FOR CORNERS MADE OF TWO PROFILES)

190N

ASOLA / SLOT

100A

ASOLA CUSTOM/ SLOT CUSTOM

100N

FORO / HOLE

100F

“forma tonda”

S21 la sua forma tonda è sicuramente un elemento che lo contraddistingue, le due semisfere costruite in materiale policarbonato ed alluminio, equipaggiato con sorgenti luminose a led fino al Cri > 97 con angoli d' apertura di 120° lo rendono estremamente elegante e funzionale. Viene fornito in due versioni Sospensioni e Soffitto e in diverse finiture.

S21 its round shape is definitely an element that distinguishes it, the two hemispheres built in polycarbonate and aluminum material, equipped with LED light sources up to Cri > 97 with 120 ° opening angles make it extremely elegant and functional. It is supplied in two versions Suspensions and Ceiling and in different finishes.

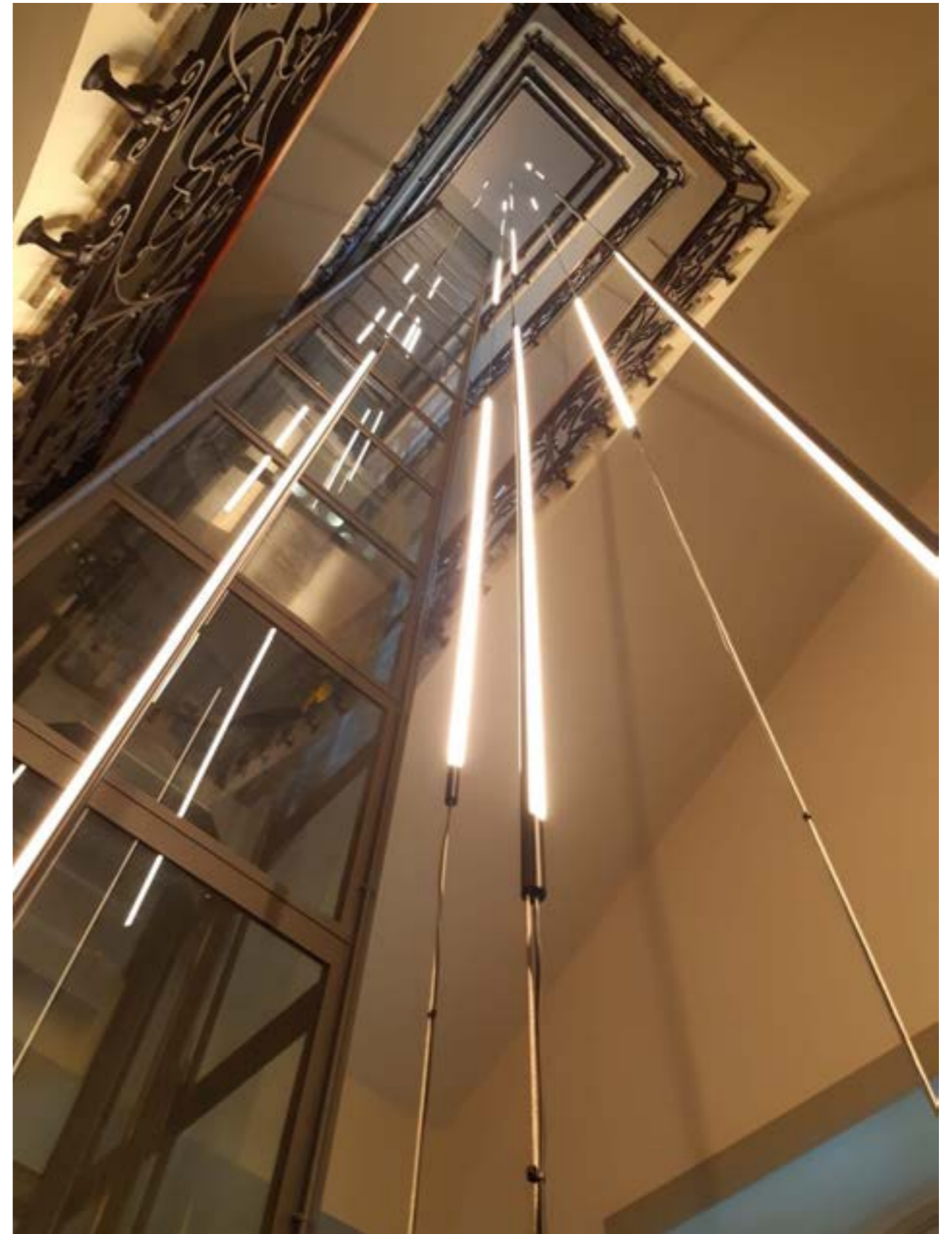

INSTALLAZIONE A SOSPENSIONE
SUSPENSION

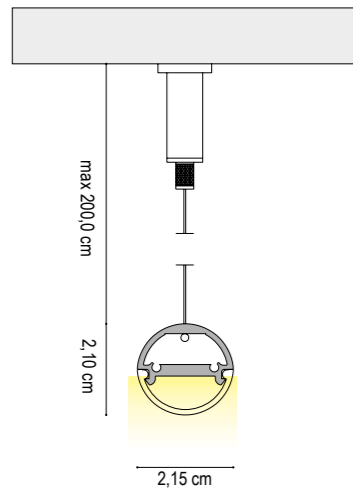

INSTALLAZIONE A SOFFITTO
CEILING INSTALLATION

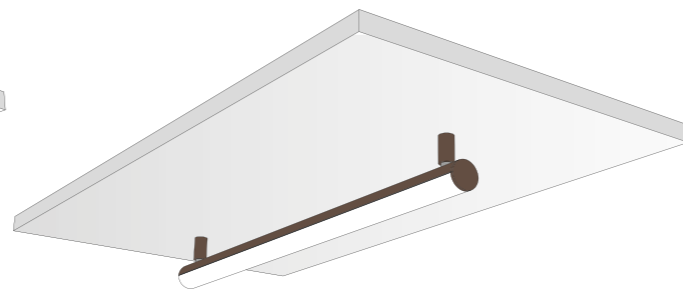
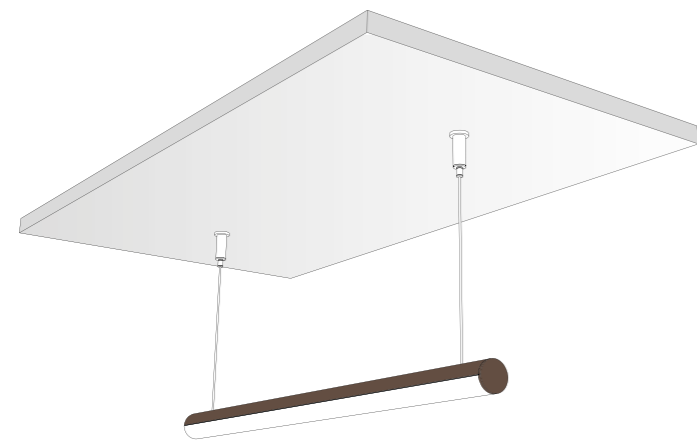
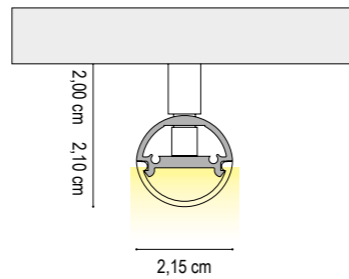

INSTALLAZIONE A SOSPENSIONE
SUSPENSION INSTALLATION

ACCESSORI INCLUSI
ACCESSORIES INCLUDED

KIT DI SOSPENSIONE / SUSPENSION KIT

INSTALLAZIONE A SOFFITTO
CEILING INSTALLATION

ACCESSORI INCLUSI
ACCESSORIES INCLUDED

KIT DI FISSAGGIO A SOFFITTO / CEILING FIXING KIT

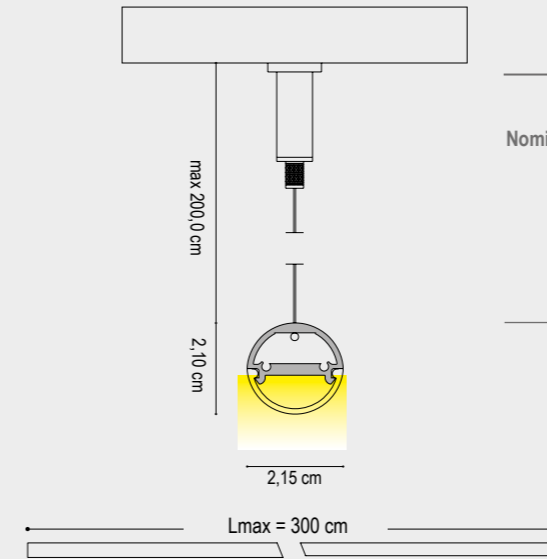

DATI TECNICI
TECHNICAL DATA

	1 cm - 20,0W/m		
Nominal LED Flux:	2100 lm/m	2200 lm/m	2300 lm/m
Flux Tot:	1680 lm/m	1760 lm/m	1880 lm/m
Output:	105 lm/W	110 lm/W	115 lm/W
CCT:	2700 K	3000 K	4000 K
CRI:	>95	>95	>95
Power Tot:	20,0W/m	20,0W/m	20,2W/m
Weight:	0.40 Kg/m	0.40 Kg/m	0.40 Kg/m

Alluminio/aluminium

Cover: Opale/opal

DRIVER NON INCLUSO / NOT INCLUDED

CAVO ALIMENTAZIONE : 50 cm
ALIMENTATION CABLE : 50 cm

FINITURA STRUTTURA
FINISHES

- GRIGIO VESUVIO ANTHRACITE
- ARGILLA CLAY
- BIANCO INTONACO/WHITE
- NERO CARAVAGGIO BLACK
- MOKA MOCHA
- CROMO CHROME
- ORO CALIFORNIA GOLD
- ARAMEN COPPER
- ARGENTO COMETA/SILVER COMET
- OTTONE VENEZIANO VENETIAN BRASS
- TITANIO/TITANIUM
- BRONZO RIACI/RIACI BRONZE
- VERDE COSTA/GREEN COAST
- TERRA SENESE SENESE EARTH

DIFFUSORE
DIFFUSER

OPALE/OPAL

1 cm - 2700K 1 cm - 3000K 1 cm - 4000K

CODICE CODE	CODICE CODE	CODICE CODE
132500001	132600001	132700001
132501001	132601001	132701001
132503001	132603001	132703001
132504001	132604001	132704001
132505001	132605001	132705001
132508001	132608001	132708001
132509001	132609001	132709001
132510001	132610001	132710001
132512001	132612001	132712001
132513001	132613001	132713001
132514001	132614001	132714001
132515001	132615001	132715001
132516001	132616001	132716001
132517001	132617001	132717001

N.B./P.N.: LUNGHEZZA MASSIMA VERSIONE CROMO = 2,00 m / MAXIMUM LENGTH CHROME VERSION = 2.00 m
TESTATE DI CHIUSURA NON INCLUSE / DEAD ENDS NOT INCLUDED

KIT DI SOSPENSIONE / SUSPENSION KIT

FINITURA STRUTTURA
FINISHES

CROMO CHROME

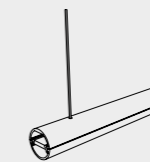

CODICE
CODE

1100508200

N.B./P.N.: PER LUNGHEZZE SUPERIORI A 200CM ORDINARE N°3 KIT / FOR LENGTHS GREATER THAN 200CM ORDER N°3 KIT

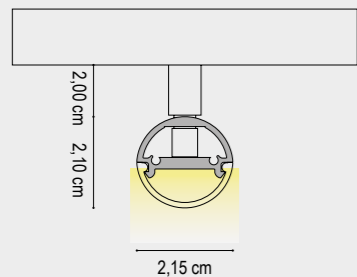

DATI TECNICI
TECHNICAL DATA

	1 cm - 19,2W/m		
Nominal LED Flux:	2100 lm/m	2000 lm/m	2300 lm/m
Flux Tot:	1680 lm/m	1760 lm/m	1880 lm/m
Output:	105 lm/W	110 lm/W	115 lm/W
CCT:	2700 K	3000 K	4000 K
CRI:	>95	>95	>95
Power Tot:	19,2W/m	19,2W/m	19,2W/m
Weight:	0.40 Kg/m	0.40 Kg/m	0.40 Kg/m

Alluminio/aluminium

Cover: Opale/opal

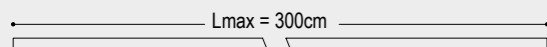

DRIVER NON INCLUSO / NOT INCLUDED

CAVO ALIMENTAZIONE : 50 cm
ALIMENTATION CABLE : 50 cm

1 cm - 2700K 1 cm - 3000K 1 cm - 4000K

FINITURA STRUTTURA
FINISHES

- GRIGIO VESUVIO ANTHRACITE
- ARGILLA CLAY
- BIANCO INTONACO/WHITE
- NERO CARAVAGGIO BLACK
- MOKA MOCHA
- CROMO/CHROME
- ORO CALIFORNIA GOLD
- ARAMEN COPPER
- ARGENTO COMETA/SILVER COMET
- OTTONE VENEZIANO/VENETIAN BRASS
- TITANIO/TITANIUM
- BRONZO RIACI/RIACI BRONZE
- VERDE COSTA/GREEN COAST
- TERRA SENESE SENESE EARTH

DIFFUSORE
DIFFUSER

- OPALE/OPAL

CODICE CODE	CODICE CODE	CODICE CODE
1325000011	1326000011	1327000011
1325010011	1326010011	1327010011
1325030011	1326030011	1327030011
1325040011	1326040011	1327040011
1325050011	1326050011	1327050011
1325080011	1326080011	1327080011
1325090011	1326090011	1327090011
1325100011	1326100011	1327100011
1325120011	1326120011	1327120011
1325130011	1326130011	1327130011
1325140011	1326140011	1327140011
1325150011	1326150011	1327150011
1325160011	1326160011	1327160011
1325170011	1326170011	1327170011

N.B./P.N.: LUNGHEZZA MASSIMA VERSIONE CROMO = 2,00 m / MAXIMUM LENGTH CHROME VERSION = 2.00 m
TESTATE DI CHIUSURA NON INCLUSE / DEAD ENDS NOT INCLUDED

ATTACCO A PLAFONE / CEILING MOUNT

FINITURA STRUTTURA FINISHES	CODICE CODE	FINITURA STRUTTURA FINISHES	CODICE CODE
GRIGIO VESUVIO ANTHRACITE	130500	ARAMEN COPPER	130510
ARGILLA CLAY	130501	ARGENTO COMETA/SILVER COMET	130512
BIANCO INTONACO/WHITE	130503	OTTONE VENEZIANO/VENETIAN BRASS	130513
NERO CARAVAGGIO BLACK	130504	TITANIO/TITANIUM	130514
MOKA MOCHA	130505	BRONZO RIACI/RIACI BRONZE	130515
CROMO/CHROME	130508	VERDE COSTA/GREEN COAST	130516
ORO CALIFORNIA GOLD	130509	TERRA SENESE SENESE EARTH	130517

N.B./P.N.: PER LUNGHEZZE SUPERIORI A 200CM ORDINARE N°3 KIT / FOR LENGTHS GREATER THAN 200CM ORDER N°3 KIT



TESTATE DI CHIUSURA / DEAD ENDS

FINITURA STRUTTURA FINISHES	CODICE CODE	FINITURA STRUTTURA FINISHES	CODICE CODE
GRIGIO VESUVIO ANTHRACITE	130400	ARAMEN COPPER	130410
ARGILLA CLAY	130401	ARGENTO COMETA/SILVER COMET	130412
BIANCO INTONACO/WHITE	130403	OTTONE VENEZIANO/VENETIAN BRASS	130413
NERO CARAVAGGIO BLACK	130404	TITANIO/TITANIUM	130414
MOKA MOCHA	130405	BRONZO RIACI/RIACI BRONZE	130415
CROMO/CHROME	130408	VERDE COSTA/GREEN COAST	130416
ORO CALIFORNIA GOLD	130409	TERRA SENESE SENESE EARTH	130417

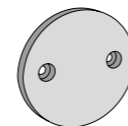

Il codice contiene 1 testata di chiusura con viti.
The code contains 1 closing warhead with screws.



“luce perfetta”

CH012 vuole essere la nostra risposta alla continua ricerca della luce perfetta, che tende a valorizzare le forme e le dimensioni degli oggetti; siano essi opere d'arte, che prodotti commerciali. Le sue forme ideate per poter essere appoggiate su superfici piane. Lo studio compiuto per garantire il migliore posizionamento della sorgente luminosa, assicurano un ottimo comfort visivo. I Led in posizione arretrata garantiscono un basso abbagliamento e consentono di emettere una luce lineare ma allo stesso tempo concentrata che tende in assoluto a valorizzare gli oggetti, le cui forme vivono di luce naturale, con una luce artificiale.

Product CH012 wants to be our answer to the continuous research in light perfection, that makes to stand out all objects of our lives whether they be artworks or commercial products. Its sinuous shapes designed to be placed in horizontal surfaces, ensures the best comfort for your eyes. The position of LED guarantee a low dazzle and emits a linear, smooth and concrete light that exalt objects living in a natural light with a beautiful artificial light.

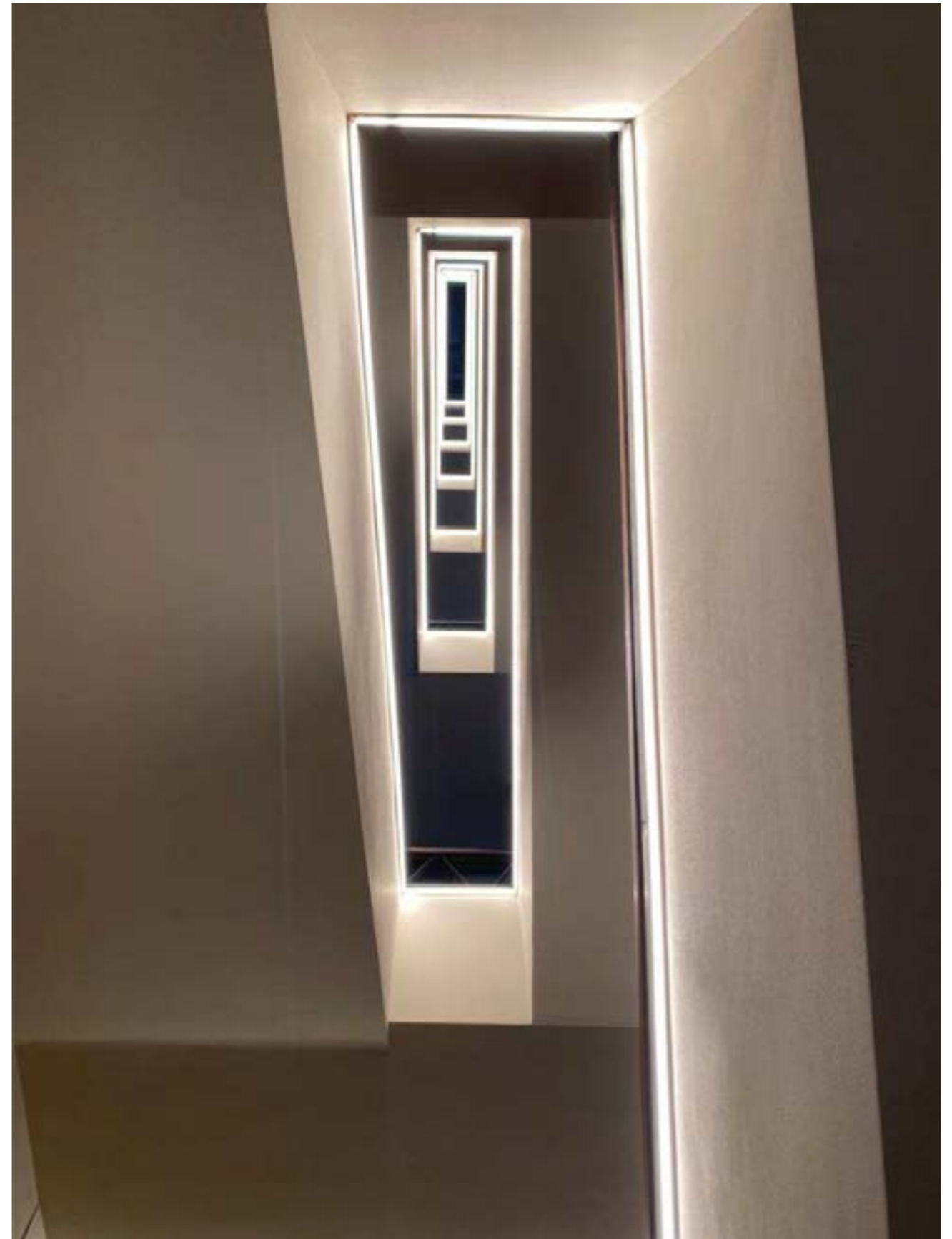

INSTALLAZIONE CON CLIP IN POLICARBONATO SU SUPERFICIE ORIZZONTALE
INSTALLATION WITH POLYCARBONATE CLIP ON HORIZONTAL SURFACE

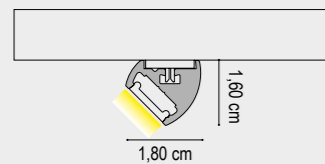

INSTALLAZIONE CON CLIP IN POLICARBONATO SU SUPERFICIE VERTICALE
INSTALLATION WITH POLYCARBONATE CLIP ON A VERTICAL SURFACE

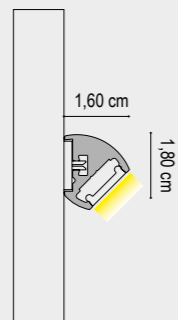

INSTALLAZIONE CON CALAMITA SU SUPERFICIE METALLICA ORIZZONTALE
INSTALLATION WITH MAGNET ON HORIZONTAL METAL SURFACE

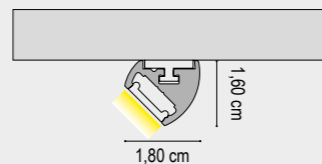

SI RACCOMANDA L'UTILIZZO DI N° 1 STAFFA MAGNETICA OGNI 25,00 cm DI PROFILO. TALE QUANTITÀ PUÒ VARIARE A SECONDA DELLA SUPERFICIE METALLICA DI INSTALLAZIONE.

WE RECOMMEND THE USE OF N° 1 MAGNETIC BRACKET EVERY 25,00 cm OF PROFILE. THIS QUANTITY MAY VARY DEPENDING ON THE METAL INSTALLATION SURFACE.

INSTALLAZIONE CON CALAMITA SU SUPERFICIE METALLICA VERTICALE
INSTALLATION WITH MAGNET ON VERTICAL METAL SURFACE

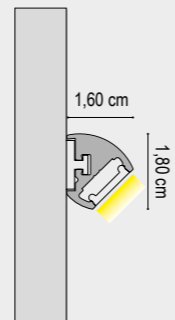

DATI TECNICI
TECHNICAL DATA

	1 cm	1 cm	1 cm
Nominal LED Flux:	1550 lm/m	1600 lm/m	1670 lm
Flux Tot:	1150 lm/m	1200 lm/m	1270 lm
Output:	108 lm/W	112 lm/W	116 lm/W
CCT:	2700 K	3000 K	4000 K
CRI:	>90	>90	>90
Power Tot:	14,4 W/m (240Led/m)	14,4 W/m (240Led/m)	14,4 W/m (240Led/m)
Weight:	0.40 Kg/m	0.40 Kg/m	0.40 Kg/m

Alluminio/aluminium

Cover: Opale/opal

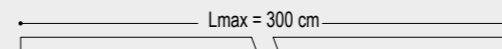
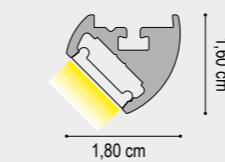

DRIVER NON INCLUSO / NOT INCLUDED

CAVO ALIMENTAZIONE : 50 cm
ALIMENTATION CABLE : 50 cm

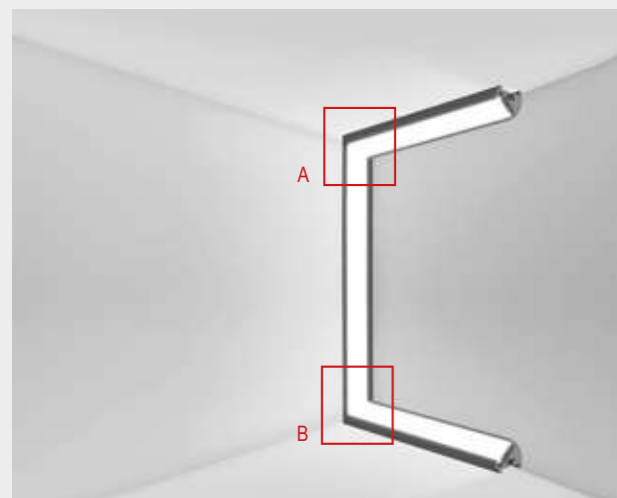

A) TAGLIO ANGOLARE - SOFFITTO/PARETE - TIPO A
A) CORNER CUT - CEILING / WALL - TYPE A
CODICE ARTICOLO / ITEM NUMBER: 190A

B) TAGLIO ANGOLARE - PARETE/SUP-ORIZZONTALE - TIPO B
B) CORNER CUT - WALL / SUP-HORIZONTAL - TYPE B
CODICE ARTICOLO / ITEM NUMBER: 190B

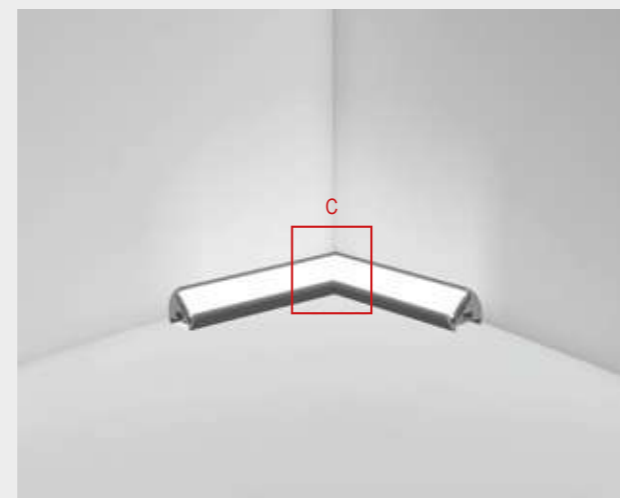

C) TAGLIO ANGOLARE - SUPERFICIE ORIZZONTALE - TIPO C
C) CORNER CUT - HORIZONTAL SURFACE - TYPE C
CODICE ARTICOLO / ITEM NUMBER: 190C

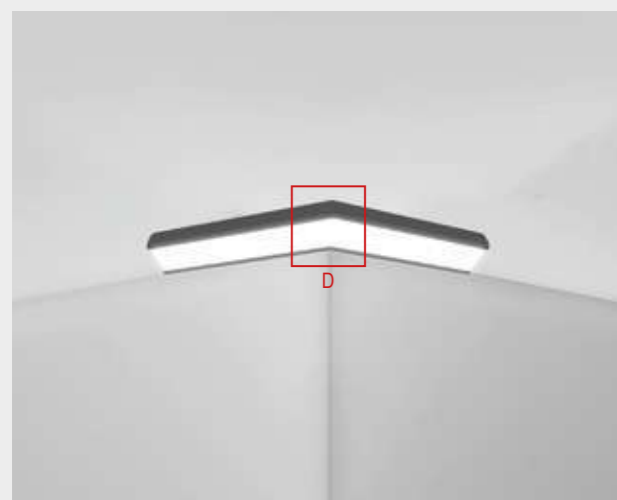

D) TAGLIO ANGOLARE - SUPERFICIE ORIZZONTALE - TIPO D
D) CORNER CUT - HORIZONTAL SURFACE - TYPE D
CODICE ARTICOLO / ITEM NUMBER: 190D

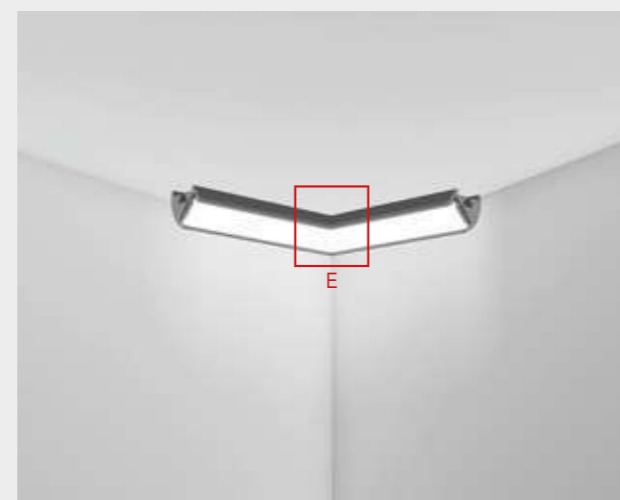

E) TAGLIO ANGOLARE - SUPERFICIE ORIZZONTALE - TIPO E
E) CORNER CUT - HORIZONTAL SURFACE - TYPE E
CODICE ARTICOLO / ITEM NUMBER: 190E

FINITURA STRUTTURA
FINISHES

- GRIGIO VESUVIO ANTHRACITE
- ARGILLA CLAY
- ARGENTO OPACO/MATT SILVER
- BIANCO INTONACO/WHITE
- NERO CARAVAGGIO/BLACK
- MOKA MOCHA
- ORO CALIFORNIA/GOLD
- ARAMEN COPPER
- ARGENTO COMETA/SILVER COMET
- OTTONE VENEZIANO/BRASS
- TITANIO/TITANIUM
- BRONZO RIACI/RIACI BRONZE
- VERDE COSTA/GREEN COAST
- TERRA SENESE/SENESE EARTH
- CROMO/CHROME

DIFFUSORE
DIFFUSER

OPALE/OPAL

	1 cm - 2700K	1 cm - 3000K	1 cm - 4000K
CODICE CODE	CODICE CODE	CODICE CODE	CODICE CODE
102N200001	102N300001	102N400001	
102N201001	102N301001	102N401001	
102N202001	102N302001	102N402001	
102N203001	102N303001	102N403001	
102N204001	102N304001	102N404001	
102N205001	102N305001	102N405001	
102N209001	102N309001	102N409001	
102N210001	102N310001	102N410001	
102N212001	102N312001	102N412001	
102N213001	102N313001	102N413001	
102N214001	102N314001	102N414001	
102N215001	102N315001	102N415001	
102N216001	102N316001	102N416001	
1020817001	102N317001	102N417001	
102N208001	102N308001	102N408001	

N.B./P.N.: LUNGHEZZA MASSIMA VERSIONE CROMO = 2,00 m / MAXIMUM LENGTH CHROME VERSION = 2.00 m
TESTATE DI CHIUSURA NON INCLUSE / DEAD ENDS NOT INCLUDED

ch012

led integrato

integrated led

ch012

led integrato

integrated led

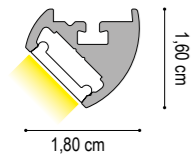

DATI TECNICI
TECHNICAL DATA

	1 cm	1 cm	1 cm
Nominal LED Flux:	1510lm/m	1590 lm/m	1680 lm/m
Flux Tot:	1208 lm/m	1272 lm/m	1350 lm/m
Output:	105 lm/W	110 lm/W	115 lm/W
CCT:	2700 K	3000 K	4000 K
CRI:	>95	>95	>95
Power Tot:	14.4 W/m (160Led/mt)	14.4 W/m (160Led/mt)	14.4 W/m (160Led/mt)
Weight:	0.40 Kg/m	0.40 Kg/m	0.40 Kg/m

Alluminio/aluminium
Cover: Opale/opal

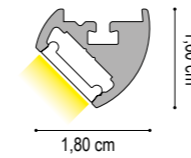

DATI TECNICI
TECHNICAL DATA

	1 cm	1 cm	1 cm
Nominal LED Flux:	2100 lm/m	2200 lm/m	2300 lm/m
Flux Tot:	1660 lm/m	1760 lm/m	1860 lm/m
Output:	105 lm/W	110 lm/W	115 lm/W
CCT:	2700 K	3000 K	4000 K
CRI:	>90	>90	>90
Power Tot:	20 W/m (240Led/m)	20 W/m (240Led/m)	20 W/m (240Led/m)
Weight:	0.40 Kg/m	0.40 Kg/m	0.40 Kg/m

Alluminio/aluminium
Cover: Opale/opal

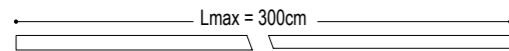

DRIVER NON INCLUSO / NOT INCLUDED

CAVO ALIMENTAZIONE : 50 cm
ALIMENTATION CABLE : 50 cm

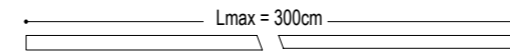

DRIVER NON INCLUSO / NOT INCLUDED

CAVO ALIMENTAZIONE : 50 cm
ALIMENTATION CABLE : 50 cm

FINITURA STRUTTURA FINISHES	DIFFUSORE DIFFUSER	1 cm - 2700K	1 cm - 3000K	1 cm - 4000K
		CODICE CODE	CODICE CODE	CODICE CODE
GRIGIO VESUVIO ANTHRACITE	OPALE/OPAL	102G10001	102G20001	102G30001
ARGILLA CLAY		102G10101	102G20101	102G30101
ARGENTO OPACO/MATT SILVER		102G10201	102G20201	102G30201
BIANCO INTONACO/WHITE		102G10301	102G20301	102G30301
NERO CARAVAGGIO BLACK		102G10401	102G20401	102G30401
MOKA MOCHA		102G10501	102G20501	102G30501
CROMO/CHROME		102G10801	102G20801	102G20801
ORO CALIFORNIA/GOLD		102G10901	102G20901	102G30901
ARAMEN COPPER		102G11001	102G21001	102G31001
ARGENTO COMETA/SILVER COMET		102G11201	102G21201	102G31201
OTTONE VENEZIANO/BRASS		102G11301	102G21301	102G31301
TITANIO/TITANIUM		102G11401	102G21401	102G31401
BRONZO RIACI/RIACI BRONZE		102G11501	102G21501	102G31501
VERDE COSTA/GREEN COAST		102G11601	102G21601	102G31601
TERRA SENESE/SENESE EARTH		102G11701	102G21701	102G31701

N.B./P.N.: LUNGHEZZA MASSIMA VERSIONE CROMO = 2,00 m / MAXIMUM LENGTH CHROME VERSION = 2.00 m
TESTATE DI CHIUSURA NON INCLUSE / DEAD ENDS NOT INCLUDED

FINITURA STRUTTURA FINISHES	DIFFUSORE DIFFUSER	1 cm - 2700K	1 cm - 3000K	1 cm - 4000K
		CODICE CODE	CODICE CODE	CODICE CODE
GRIGIO VESUVIO ANTHRACITE	OPALE/OPAL	102250001	102260001	102270001
ARGILLA CLAY		102250101	102260101	102270101
ARGENTO OPACO/MATT SILVER		102250201	102260201	102270201
BIANCO INTONACO/WHITE		102250301	102260301	102270301
NERO CARAVAGGIO BLACK		102250401	102260401	102270401
MOKA MOCHA		102250501	102260501	102270501
CROMO/CHROME		102250801	102260801	102270801
ORO CALIFORNIA/GOLD		102250901	102260901	102270901
ARAMEN COPPER		102251001	102261001	102271001
ARGENTO COMETA/SILVER COMET		102251201	102261201	102271201
OTTONE VENEZIANO/BRASS		102251301	102261301	102271301
TITANIO/TITANIUM		102251401	102261401	102271401
BRONZO RIACI/RIACI BRONZE		102251501	102261501	102271501
VERDE COSTA/GREEN COAST		102251601	102261601	102271601
TERRA SENESE/SENESE EARTH		102251701	102261701	102271701

N.B./P.N.: LUNGHEZZA MASSIMA VERSIONE CROMO = 2,00 m / MAXIMUM LENGTH CHROME VERSION = 2.00 m
TESTATE DI CHIUSURA NON INCLUSE / DEAD ENDS NOT INCLUDED

ch012

led non integrato

not integrated led

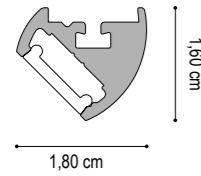

Diffusore in policarbonato
Polycarbonate diffuser

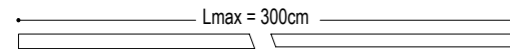

FINITURA STRUTTURA FINISHES	DIFFUSORE DIFFUSER	1 cm	200 cm	300 cm
		CODICE CODE	CODICE CODE	CODICE CODE
GRIGIO VESUVIO ANTHRACITE	OPALE/OPAL	102CP00001	102CP00200	102CP00300
ARGILLA CLAY		102CP01001	102CP01200	102CP01300
ARGENTO OPACO MATT SILVER		102CP02001	102CP02200	102CP02300
BIANCO INTONACO/WHITE		102CP03001	102CP03200	102CP03300
NERO CARAVAGGIO BLACK		102CP04001	102CP04200	102CP04300
MOKA MOCHA		102CP05001	102CP05200	102CP05300
ALLUMINIO NATURALE/ALUMINUM		102CP06001	102CP06200	102CP06300
ORO CALIFORNIA/GOLD		102CP09001	102CP09200	102CP09300
ARAMEN COPPER		102CP10001	102CP10200	102CP10300
ARGENTO COMETA/SILVER COMET		102CP12001	102CP12200	102CP12300
OTTONE VENEZIANO BRASS		102CP13001	102CP13200	102CP13300
TITANIO/TITANIUM		102CP14001	102CP14200	102CP14300
BRONZO RIACI/RIACI BRONZE		102CP15001	102CP15200	102CP15300
VERDE COSTA/GREEN COAST		102CP16001	102CP16200	102CP16300
TERRA SENESE SENESE EARTH		102CP17001	102CP17200	102CP17300
CROMO CHROME		102CP08001	102CP08200	

N.B./P.N.:
LUNGHEZZA MASSIMA VERSIONE CROMO = 2,00 m / MAXIMUM LENGTH CHROME VERSION = 2.00 m

LED compatibili / LED compatibility

HIGH QUALITY CRI>90 CRI>95	HIGH OUTPUT CRI>90 CRI>95	HIGH EFFICIENT CRI>90 CRI>95	HIGH INTENSITY CRI>90 CRI>95	LOW POWER CRI>90	ULTRA SLIM CRI>90 CRI>95 CRI>97	RGB	RGB WHITE	RGB TW	TUNABLE WHITE
9,6W 14,4W 19,2W	12,3W 14,4W 19,2W 20W 24W	11,0W 12,3W 14,4W 19,2W 20W 24W	24W (700 LED)	6W	7,0W 9,6W 12W 14,4W	14W	14W	14,4W 23W	19,2W



ch012

led non integrato

not integrated led

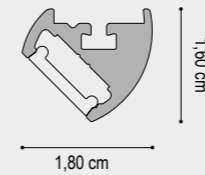

Diffusore Satinato
Satin diffuser

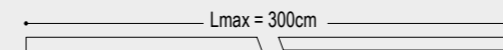

FINITURA STRUTTURA FINISHES	DIFFUSORE DIFFUSER	1 cm	200 cm	300 cm
		CODICE CODE	CODICE CODE	CODICE CODE
GRIGIO VESUVIO ANTHRACITE	SATINATA/SATIN	102CS00001	102CS00200	102CS00300
ARGILLA CLAY		102CS01001	102CS01200	102CS01300
ARGENTO OPACO MATT SILVER		102CS02001	102CS02200	102CS02300
BIANCO INTONACO/WHITE		102CS03001	102CS03200	102CS03300
NERO CARAVAGGIO BLACK		102CS04001	102CS04200	102CS04300
MOKA MOCHA		102CS05001	102CS05200	102CS05300
ALLUMINIO NATURALE/ALUMINUM		102CS06001	102CS06200	102CS06300
ORO CALIFORNIA/GOLD		102CS09001	102CS09200	102CS09300
ARAMEN COPPER		102CS10001	102CS10200	102CS10300
ARGENTO COMETA/SILVER COMET		102CS12001	102CS12200	102CS12300
OTTONE VENEZIANO BRASS		102CS13001	102CS13200	102CS13300
TITANIO/TITANIUM		102CS14001	102CS14200	102CS14300
BRONZO RIACI/RIACI BRONZE		102CS15001	102CS15200	102CS15300
VERDE COSTA/GREEN COAST		102CS16001	102CS16200	102CS16300
TERRA SENESE SENESE EARTH		102CS17001	102CS17200	102CS17300
CROMO CHROME		102CS08001	102CS08200	

N.B./P.N.:
LUNGHEZZA MASSIMA VERSIONE CROMO = 2,00 m / MAXIMUM LENGTH CHROME VERSION = 2.00 m

LED compatibili / LED compatibility **NEW**

48V ONE CHIP CUT CRI>90 CRI>95	TWO CHIPS CUT CRI>90 CRI>95	SLIM ONE CHIP CUT CRI>90 CRI>95
8,0W 12,0W 19,2W	14,4W 24,0W	7,0W 9,0W 19,2W



TESTATE DI CHIUSURA / DEAD ENDS

FINITURA STRUTTURA FINISHES	CODICE CODE	FINITURA STRUTTURA FINISHES	CODICE CODE
GRIGIO VESUVIO ANTHRACITE	1020400000	ORO CALIFORNIA/GOLD	1020409000
ARGILLA CLAY	1020401000	ARAMEN COPPER	1020410000
ARGENTO OPACO/MATT SILVER	1020402000	ARGENTO COMETA/SILVER COMET	1020412000
BIANCO INTONACO/WHITE	1020403000	OTTONE VENEZIANO BRASS	1020413000
NERO CARAVAGGIO/BLACK	1020404000	TITANIO/TITANIUM	1020414000
MOKA MOCHA	1020405000	BRONZO RIACI/RIACI BRONZE	1020415000
ALLUMINIO NATURALE/ALUMINUM	1020406000	VERDE COSTA/GREEN COAST	1020416000
CROMO/CHROME	1020408000	TERRA SENESE SENESE EARTH	1020417000

Il codice contiene 1 testata di chiusura con viti.
The code contains 1 closing warhead with screws.

GIUNTI / JOINTS

GIUNTO LINEA CONTINUA / STRAIGHT JOINT	GIUNTO 90° ORIZZONTALE / HORIZONTAL JOINT 90°	GIUNTO 90° VERTICALE / VERTICAL JOINT 90°	FINITURA FINISHES	CODICE CODE
Accessorio per giunzioni meccaniche lineari Accessory for linear mechanical joints	Accessorio per giunzioni meccaniche con angolo 90° Accessory for linear mechanical joints with 90° angle	Accessorio per giunzioni meccaniche con angolo 90° Accessory for linear mechanical joints with 90° angle	ALLUMINIO NATURALE/ALUMINUM	1010500006
			ALLUMINIO NATURALE/ALUMINUM	1010500005
			ALLUMINIO NATURALE/ALUMINUM	1010500007

Il codice contiene i grani per il fissaggio del giunto.
The code contains the grains to fix the joint.

STAFFA DI FISSAGGIO A DOPPIO ATTACCO / DOUBLE MOUNTING CLIP CALAMITA / MAGNET

FINITURA FINISHES	CODICE CODE	CODICE CODE	PORTATA RANGE
SUPERFICI PIANE 2mm EVEN SURFACE 2mm	1020500005	1020500010	1 Kg
SUPERFICI IRREGOLARI 3,9mm UNEVEN SURFACE 3,9mm	1020500006	1020500210	2 Kg

Accessorio per fissaggio a plafone/superficie. Quantità raccomandata: 1 pz ogni 50 cm di modello.

Ceiling/surface mounting accessory. Recommended quantity 1 pc every 50 cm of model.

Quantità raccomandata: 1 pz ogni 25 cm di modello.

Recommended quantity: 1 pc every 25 cm of model.

INTERRUTTORE DIMMERABILE+INSTALLAZIONE / DIMMABLE SWITCH+INSTALLATION

DATI TECNICI TECHNICAL DATA	FINITURA STRUTTURA FINISHES	CODICE CODE
Accessorio che consente l'accensione e lo spegnimento dei LED e, a seconda della pressione, la regolazione dell'intensità luminosa. Accessory that allows the switching on and off of the LEDs and, depending on the pressure, the regulation of the light intensity.	ALLUMINIO NATURALE/ALUMINUM	98244

Tensione di alimentazione: 12-24V DC
Supply voltage: 12-24V DC
Corrente d'uscita: 4A max
Output current: 4A max
ON / OFF: contact < 0.7 s
DIMMER: contact > 0.7 s

VERSIONE KIT / KIT VERSION

ARTICOLO INCLUSI NEL CODICE ARTICLES INCLUDED IN THE CODE	DIFFUSORE DIFFUSER	FINITURA FINISHES	CODICE CODE
Modello / model Diffusore / diffuser N°2 testate di chiusura / N.2 closing heads N°3 staffe di fissaggio per superfici irregolare 3mm N.3 fixing brackets for uneven surfaces 3mm	OPALE/OPAL	ARGENTO OPACO/MATT SILVER BIANCO INTONACO/WHITE NERO CARAVAGGIO/BLACK	200 cm 102P22 102P32 102P42
	SATINATA/SATIN	ARGENTO OPACO/MATT SILVER BIANCO INTONACO/WHITE NERO CARAVAGGIO/BLACK	102S22 102S32 102S42

LAVORAZIONI / PROCESSING

DATI TECNICI TECHNICAL DATA	CODICE CODE
TAGLIO ANGOLARE 90° (PER ANGOLI FORMATI DA DUE PROFILI) TIPO A 90 ° CORNER CUT (FOR CORNERS MADE OF TWO PROFILES) - TYPE A	190A
TAGLIO ANGOLARE 90° (PER ANGOLI FORMATI DA DUE PROFILI) TIPO B 90 ° CORNER CUT (FOR CORNERS MADE OF TWO PROFILES) - TYPE B	190B
TAGLIO ANGOLARE 90° (PER ANGOLI FORMATI DA DUE PROFILI) TIPO C 90 ° CORNER CUT (FOR CORNERS MADE OF TWO PROFILES) - TYPE C	190C
TAGLIO ANGOLARE 90° (PER ANGOLI FORMATI DA DUE PROFILI) TIPO D 90 ° CORNER CUT (FOR CORNERS MADE OF TWO PROFILES) - TYPE D	190D
TAGLIO ANGOLARE 90° (PER ANGOLI FORMATI DA DUE PROFILI) TIPO E 90 ° CORNER CUT (FOR CORNERS MADE OF TWO PROFILES) - TYPE E	190E
TAGLIO ANGOLARE CUSTOM (PER ANGOLI FORMATI DA DUE PROFILI) CUSTOM CORNER CUT (FOR CORNERS MADE OF TWO PROFILES)	190N
ASOLA / SLOT	100A
FORO / HOLE	100F
CABLAGGIO - COLLAUDO - CE AL CENTIMETRO INSTALLATION AND TESTING LED MODULE AT CENTIMETER	1021
CONNETTORE MASCHIO/FEMMINA MALE/FEMALE CONNECTOR	98CFM
CONNETTORE MASCHIO/FEMMINA MONTATO NEL PRODOTTO MALE/FEMALE CONNECTOR FITTED IN THE PRODUCT	98MFM
CAVO DI ALIMENTAZIONE 2X0,50 BIANCO 1CM POWER CABLE 2X0,50 WHITE 1CM	98CB001
CAVO DI ALIMENTAZIONE 2X0,50 NERO 1CM POWER CABLE 2X0,50 BLACK 1CM	98CN001
CAVO DI ALIMENTAZIONE IN STAGNO 2X0,75 MARRONE 1CM POWER CABLE IN STAGNO 2X0,75 BROWN 1CM	98CS001

“fascio luminoso a 45°”

LC020 grazie alla sua forma innovativa e al posizionamento della sorgente luminosa abbinato al diffusore in policarbonato opalino arretrato ed inclinato, consente un fascio luminoso a 45°. Se abbinato alla nostra gamma di led ad alta resa cromatica CRI >95 e CRI > 97 assolve al compito di esaltare gli oggetti nei colori, e nelle forme, contribuendo ad esaltarne l'immagine nella sua interezza.

LC020 thanks to its innovative shape and the positioning of the light source combined with the backward and inclined opal polycarbonate diffuser, allows a 45 ° light beam. If combined with our range of high color rendering LEDs CRI> 95 and CRI> 97, it fulfills the task of enhancing objects in colors and shapes, contributing to enhancing their image in its entirety.



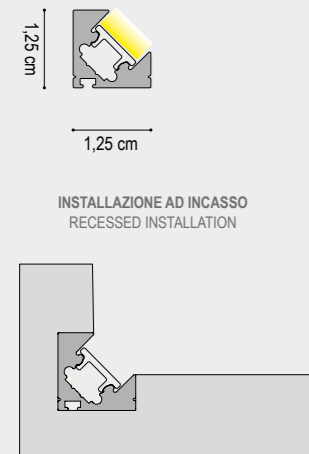

INSTALLAZIONE AD INCASSO
RECESSED INSTALLATION

INSTALLAZIONE SU SUPERFICI ORIZZONTALI E VERTICALI
INSTALLATION ON HORIZONTAL AND VERTICAL SURFACES

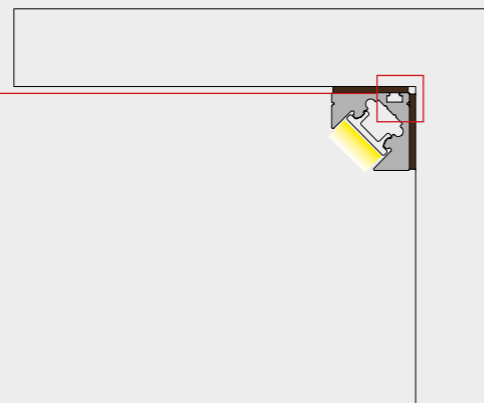

IL PRODOTTO LC020 NON PREVEDE ACCESSORI PER L'INSTALLAZIONE. IL FISSAGGIO A SUPERFICIE DEVE ESSERE REALIZZATO MEDIANTE APPOSITI COLLANTI O NASTRO BIADRESIVO. SI RACCOMANDA DI SCEGLIERE IL METODO DI FISSAGGIO ADATTO ALLA SUPERFICIE DI INSTALLAZIONE.

THE LC020 PRODUCT DOES NOT PROVIDE ACCESSORIES FOR INSTALLATION. SURFACE MOUNTING MUST BE MADE USING SPECIAL ADHESIVES OR DOUBLE-SIDED TAPE. IT IS RECOMMENDED TO CHOOSE THE FASTENING METHOD SUITABLE FOR THE INSTALLATION SURFACE.

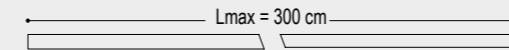
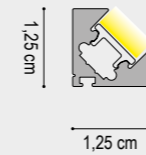

DATI TECNICI
TECHNICAL DATA

	1 cm	1 cm	1 cm
Nominal LED Flux:	1800 lm/m	1900 lm/m	1990 lm/m
Flux Tot:	1420 lm/m	1520 lm/m	1430 lm/m
Output:	150 lm/W	158 lm/W	166 lm/W
CCT:	2700 K	3000 K	4000 K
CRI:	>90	>90	>90
Power Tot:	12.0W/m	12.0W/m	12.0W/m
Weight:	0.20 Kg/m	0.20 Kg/m	0.20 Kg/m

Alluminio/aluminum
Cover: Opale/opal

DRIVER NON INCLUSO / NOT INCLUDED

CAVO ALIMENTAZIONE : 50 cm
ALIMENTATION CABLE : 50 cm

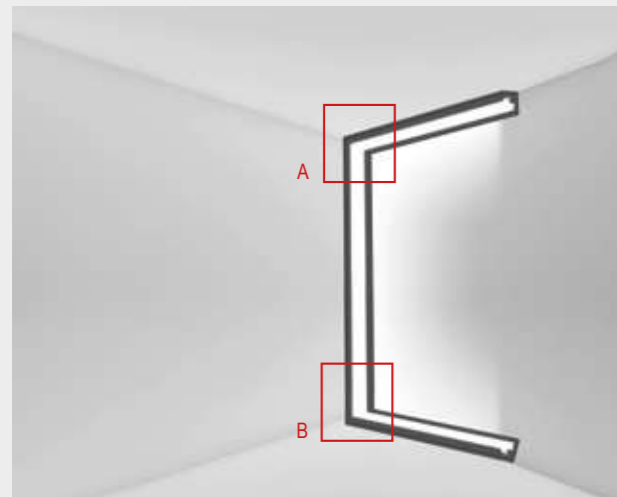

A) TAGLIO ANGOLARE - SOFFITTO/PARETE - TIPO A
A) CORNER CUT - CEILING / WALL - TYPE A
CODICE ARTICOLO / ITEM NUMBER: 190A

B) TAGLIO ANGOLARE - PARETE/SUP-ORIZZONTALE - TIPO B
B) CORNER CUT - WALL / SUP-HORIZONTAL - TYPE B
CODICE ARTICOLO / ITEM NUMBER: 190B

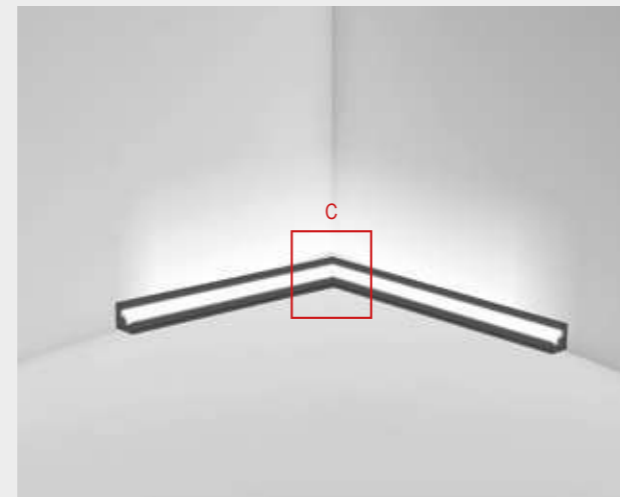

C) TAGLIO ANGOLARE - SUPERFICIE ORIZZONTALE - TIPO C
C) CORNER CUT - HORIZONTAL SURFACE - TYPE C
CODICE ARTICOLO / ITEM NUMBER: 190C

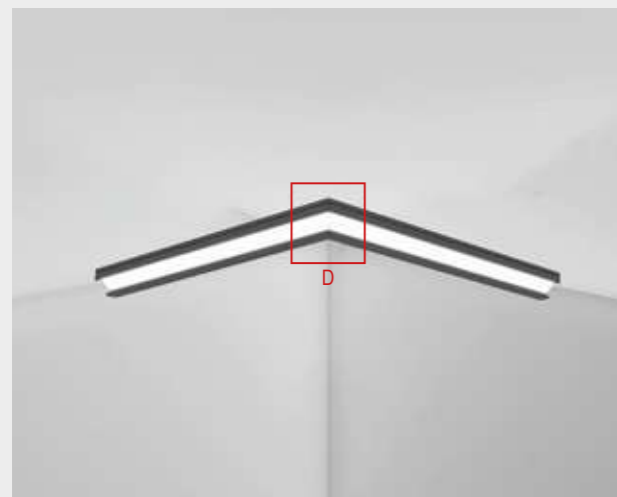

D) TAGLIO ANGOLARE - SUPERFICIE ORIZZONTALE - TIPO D
D) CORNER CUT - HORIZONTAL SURFACE - TYPE D
CODICE ARTICOLO / ITEM NUMBER: 190D

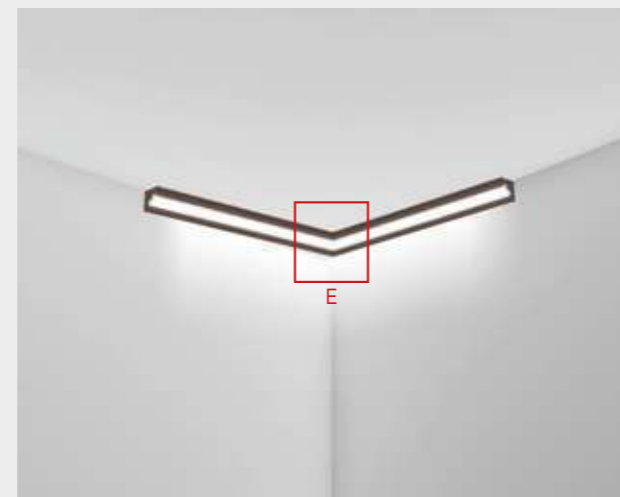

E) TAGLIO ANGOLARE - SUPERFICIE ORIZZONTALE - TIPO E
E) CORNER CUT - HORIZONTAL SURFACE - TYPE E
CODICE ARTICOLO / ITEM NUMBER: 190E

FINITURA STRUTTURA
FINISHES

- GRIGIO VESUVIO ANTHRACITE
- ARGILLA CLAY
- ARGENTO OPACO/MATT SILVER
- BIANCO INTONACO/WHITE
- NERO CARAVAGGIO BLACK
- MOKA MOCHA
- CROMO CHROME
- ORO CALIFORNIA GOLD
- ARAMEN COPPER
- ARGENTO COMETA/SILVER COMET
- OTTONE VENEZIANO/BRASS
- TITANIO/TITANIUM
- BRONZO RIACI/RIACI BRONZE
- VERDE COSTA/GREEN COAST
- TERRA SENESE SENESE EARTH

DIFFUSORE
DIFFUSER

OPALE/OPAL

	1 cm - 2700K	1 cm - 3000K	1 cm - 4000K
CODICE CODE	CODICE CODE	CODICE CODE	CODICE CODE
1254000001	1255000001	1256000001	
1254010001	1255010001	1256010001	
1254020001	1255020001	1256020001	
1254030001	1255030001	1256030001	
1254040001	1255040001	1256040001	
1254050001	1255050001	1256050001	
1254080001	1255080001	1256080001	
1254090001	1255090001	1256090001	
1254100001	1255100001	1256100001	
1254120001	1255120001	1256120001	
1254130001	1255130001	1256130001	
1254140001	1255140001	1256140001	
1254150001	1255150001	1256150001	
1254160001	1255160001	1256160001	
1254170001	1255170001	1256170001	

N.B./P.N.: LUNGHEZZA MASSIMA VERSIONE CROMO = 2,00 m / MAXIMUM LENGTH CHROME VERSION = 2.00 m
TESTATE DI CHIUSURA NON INCLUSE / DEAD ENDS NOT INCLUDED

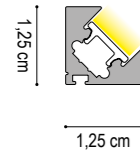
DATI TECNICI
TECHNICAL DATA

	1 cm	1 cm	1 cm
Nominal LED Flux:	1560 lm/m	1620 lm/m	1680 lm/m
Flux Tot:	1248 lm/m	1305 lm/m	1348 lm/m
Output:	130 lm/W	135 lm/W	140 lm/W
CCT:	2700 K	3000 K	4000 K
CRI:	>97 - R9>90	>97 - R9>90	>97 - R9>90
Power Tot:	12.0W/m	12.0W/m	12.0W/m
Weight:	0.20 Kg/m	0.20 Kg/m	0.20 Kg/m

Alluminio/aluminum
Cover: Opale/opal

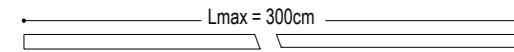

DRIVER NON INCLUSO / NOT INCLUDED

CAVO ALIMENTAZIONE : 50 cm
ALIMENTATION CABLE : 50 cm

Diffusore in policarbonato
Polycarbonate diffuser

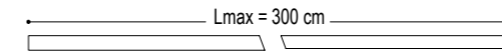
FINITURA STRUTTURA
FINISHES

GRIGIO VESUVIO ANTHRACITE
ARGILLA CLAY
ARGENTO OPACO MATT SILVER
BIANCO INTONACO/WHITE
NERO CARAVAGGIO BLACK
MOKA MOCHA
CROMO/CHROME
ORO CALIFORNIA/GOLD
ARAMEN COPPER
ARGENTO COMETA/SILVER COMET
OTTONE VENEZIANO BRASS
TITANIO/TITANIUM
BRONZO RIACI/RIACI BRONZE
VERDE COSTA/GREEN COAST
TERRA SENESE SENESE EARTH

DIFFUSORE
DIFFUSER

OPALE/OPAL

1 cm - 2700K 1 cm - 3000K 1 cm - 4000K

CODICE CODE	CODICE CODE	CODICE CODE
129600001	129700001	129800001
129601001	129701001	129801001
129602001	129702001	129802001
129603001	129703001	129803001
129604001	129704001	129804001
129605001	129705001	129805001
129608001	129708001	129808001
129609001	129709001	129809001
129610001	129710001	129810001
129612001	129712001	129812001
129613001	129713001	129813001
129614001	129714001	129814001
129615001	129715001	129815001
129616001	129716001	129816001
129617001	129717001	129817001

N.B./P.N.: LUNGHEZZA MASSIMA VERSIONE CROMO = 2,00 m / MAXIMUM LENGTH CHROME VERSION = 2.00 m
TESTATE DI CHIUSURA NON INCLUSE / DEAD ENDS NOT INCLUDED

FINITURA STRUTTURA
FINISHES

GRIGIO VESUVIO ANTHRACITE
ARGILLA CLAY
ARGENTO OPACO MATT SILVER
BIANCO INTONACO/WHITE
NERO CARAVAGGIO BLACK
MOKA MOCHA
ALLUMINIO NATURALE/ALUMINUM
ORO CALIFORNIA/GOLD
ARAMEN COPPER
ARGENTO COMETA/SILVER COMET
OTTONE VENEZIANO BRASS
TITANIO/TITANIUM
BRONZO RIACI/RIACI BRONZE
VERDE COSTA/GREEN COAST
TERRA SENESE SENESE EARTH
CROMO/CHROME

DIFFUSORE
DIFFUSER

OPALE/OPAL

1 cm 200 cm 300 cm

CODICE CODE	CODICE CODE	CODICE CODE
12CP00001	12CP000200	12CP000300
12CP01001	12CP010200	12CP010300
12CP02001	12CP020200	12CP020300
12CP03001	12CP030200	12CP030300
12CP04001	12CP040200	12CP040300
12CP05001	12CP050200	12CP050300
12CP06001	12CP060200	12CP060300
12CP09001	12CP090200	12CP090300
12CP10001	12CP100200	12CP100300
12CP12001	12CP120200	12CP120300
12CP13001	12CP130200	12CP130300
12CP14001	12CP140200	12CP140300
12CP15001	12CP150200	12CP150300
12CP16001	12CP160200	12CP160300
12CP17001	12CP170200	12CP170300
12CP08001	12CP080200	

N.B./P.N.: LUNGHEZZA MASSIMA VERSIONE CROMO = 2,00 m / MAXIMUM LENGTH CHROME VERSION = 2.00 m
TESTATE DI CHIUSURA NON INCLUSE / DEAD ENDS NOT INCLUDED

LED compatibili / LED compatibility **NEW**

ULTRA SLIM CRI>90 CRI>95 CRI>97	RGB SLIM	SLIM ONE CHIP
7,0W	14,4W	7,0W
9,6W		9,0W
12W		19,2W
14,4W		

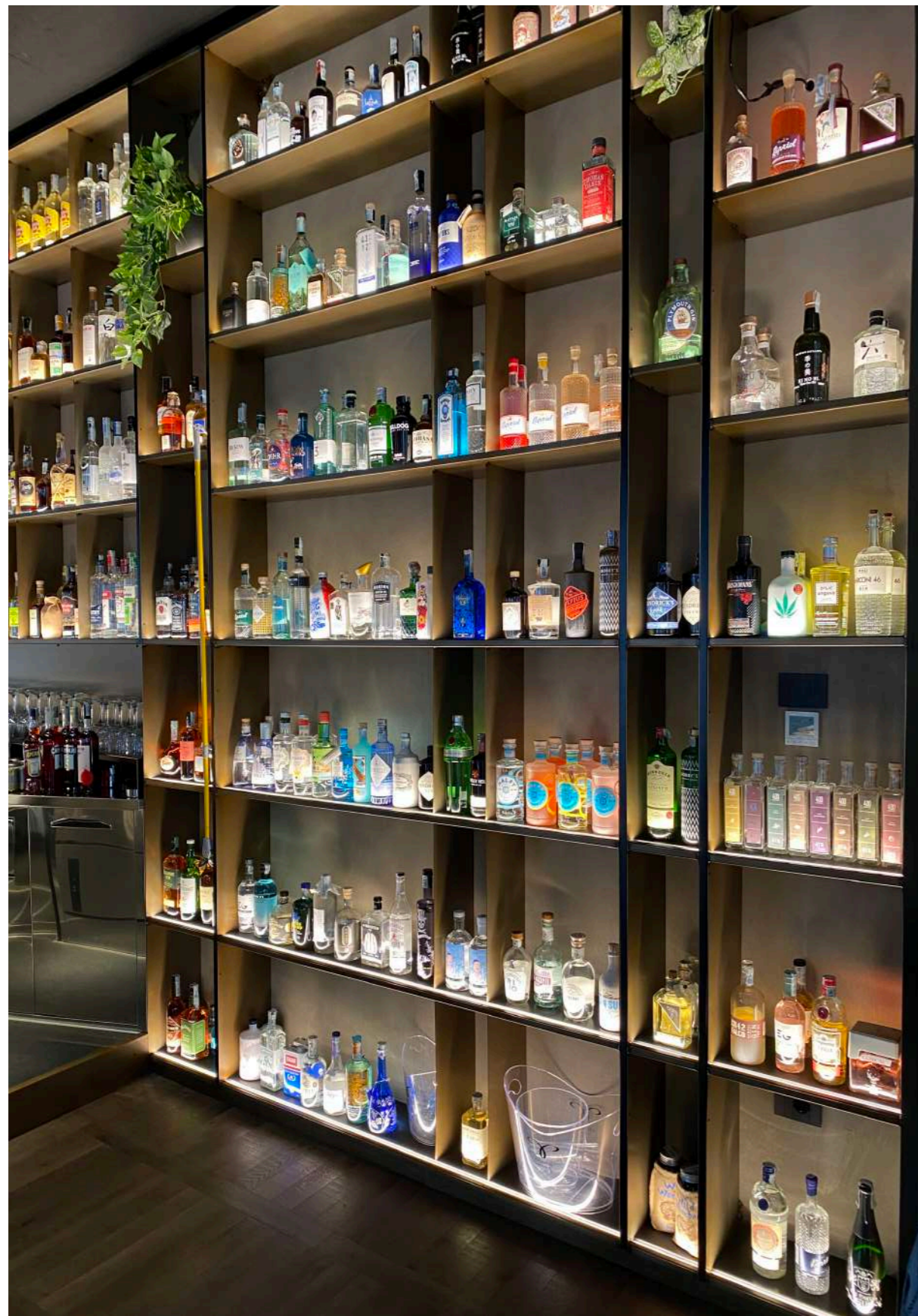

TESTATE DI CHIUSURA / DEAD ENDS

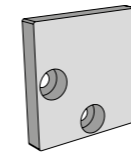

FINITURA STRUTTURA FINISHES	CODICE CODE	FINITURA STRUTTURA FINISHES	CODICE CODE
GRIGIO VESUVIO ANTHRACITE	120400	ORO CALIFORNIA/GOLD	120409
ARGILLA CLAY	120401	ARAMEN COPPER	120410
ARGENTO OPACO/MATT SILVER	120402	ARGENTO COMETA/SILVER COMET	120412
BIANCO INTONACO/WHITE	120403	OTTONE VENEZIANO/BRASS	120413
NERO CARAVAGGIO BLACK	120404	TITANIO/TITANIUM	120414
MOKA MOCHA	120405	BRONZO RIACIURIACI BRONZE	120415
ALLUMINIO NATURALE/ALUMINUM	120406	VERDE COSTA/GREEN COAST	120416
CROMO/CHROME	120408	TERRA SENESE SENESE EARTH	120417

Il codice contiene 1 testata di chiusura con viti.
The code contains 1 closing warhead with screws.

LAVORAZIONI / PROCESSING

DATI TECNICI
TECHNICAL DATA

DATI TECNICI TECHNICAL DATA	CODICE CODE
TAGLIO ANGOLARE 90° (PER ANGOLI FORMATI DA DUE PROFILI) TIPO A 90 ° CORNER CUT (FOR CORNERS MADE OF TWO PROFILES) - TYPE A	190A
TAGLIO ANGOLARE 90° (PER ANGOLI FORMATI DA DUE PROFILI) TIPO B 90 ° CORNER CUT (FOR CORNERS MADE OF TWO PROFILES) - TYPE B	190B
TAGLIO ANGOLARE 90° (PER ANGOLI FORMATI DA DUE PROFILI) TIPO C 90 ° CORNER CUT (FOR CORNERS MADE OF TWO PROFILES) - TYPE C	190C
TAGLIO ANGOLARE 90° (PER ANGOLI FORMATI DA DUE PROFILI) TIPO D 90 ° CORNER CUT (FOR CORNERS MADE OF TWO PROFILES) - TYPE D	190D
TAGLIO ANGOLARE 90° (PER ANGOLI FORMATI DA DUE PROFILI) TIPO E 90 ° CORNER CUT (FOR CORNERS MADE OF TWO PROFILES) - TYPE E	190E
TAGLIO ANGOLARE CUSTOM (PER ANGOLI FORMATI DA DUE PROFILI) CUSTOM CORNER CUT (FOR CORNERS MADE OF TWO PROFILES)	190N



ASOLA / SLOT
FORO / HOLE

100A
100F



CABLAGGIO - COLLAUDO - CE AL CENTIMETRO
INSTALLATION AND TESTING LED MODULE AT CENTIMETER

1201



CONNETTORE MASCHIO/FEMMINA
MALE/FEMALE CONNECTOR

98CFM

CONNETTORE MASCHIO/FEMMINA MONTATO NEL PRODOTTO
MALE/FEMALE CONNECTOR FITTED IN THE PRODUCT

98MFM

CAVO DI ALIMENTAZIONE 2X0,50 BIANCO 1CM
POWER CABLE 2X0,50 WHITE 1CM

98CB001



CAVO DI ALIMENTAZIONE 2X0,50 NERO 1CM
POWER CABLE 2X0,50 BLACK 1CM

98CN001

“prodotto estremamente versatile”

LC014 è il brillante risultato della nostra vocazione alla continua ricerca di soluzioni luminose che tendono a risolvere e soddisfare le esigenze illuminotecniche della nostra clientela. La finalità iniziale del nostro studio era quella di realizzare un prodotto estremamente versatile.

Il Design studiato per rendere possibile un'installazione da incasso, semi incasso o da parete. LC014 è la soluzione ideale per illuminare piccoli spazi come vetrine oppure ambienti più grandi usandolo anche come cornice luminosa a luce indiretta per valorizzare soffitti a volte oppure può essere utilizzata come luce diretta per illuminare sale, corridoi, ecc.

LC014 is the brilliant result of our continuous researches for lighting solutions, which tend to resolve and satisfy our customers lighting requirements. The original purpose of our study was to create an extremely versatile product, the design studied to realize recessed, semi-recessed or on wall installation's. LC014 is a perfect solution to illuminate small spaces like vitrines but also large areas, installing it like indirect lighting frames, that increase ceilings values. Ideal also to realize direct lightings in big halls, corridors and others.

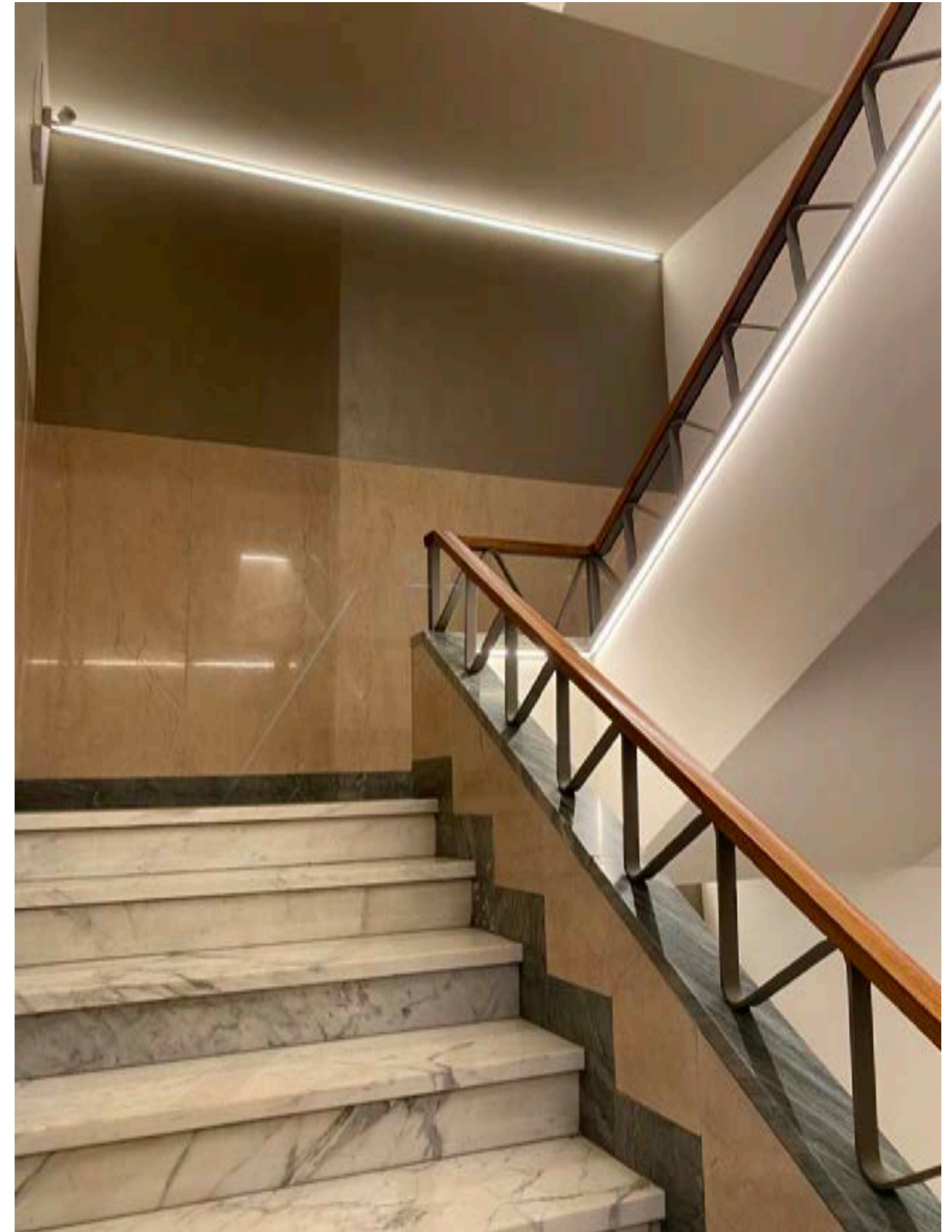



INSTALLAZIONE CON CLIP IN POLICARBONATO SU SUPERFICIE ORIZZONTALE
INSTALLATION WITH POLYCARBONATE CLIP ON HORIZONTAL SURFACE

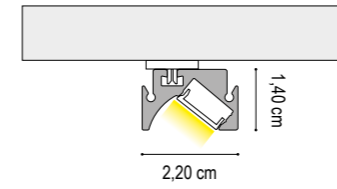

INSTALLAZIONE CON STAFFA MAGNETICA SU SUPERFICIE METALLICA ORIZZONTALE
INSTALLATION WITH MAGNET ON HORIZONTAL METAL SURFACE

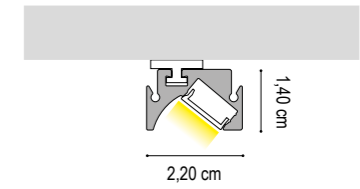

SI RACCOMANDA L'UTILIZZO DI N° 1 STAFFA MAGNETICA OGNI 25,00 cm DI PROFILO. TALE QUANTITÀ PUÒ VARIARE A SECONDA DELLA SUPERFICIE METALLICA DI INSTALLAZIONE.

WE RECOMMEND THE USE OF N° 1 MAGNETIC BRACKET EVERY 25.00 cm OF PROFILE. THIS QUANTITY MAY VARY DEPENDING ON THE METAL INSTALLATION SURFACE.

INSTALLAZIONE CON CLIP IN POLICARBONATO SU SUPERFICIE VERTICALE
INSTALLATION WITH POLYCARBONATE CLIP ON A VERTICAL SURFACE

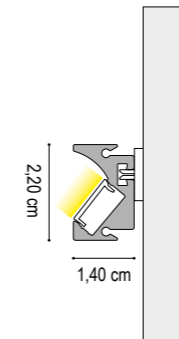

INSTALLAZIONE CON STAFFA MAGNETICA SU SUPERFICIE METALLICA VERTICALE
INSTALLATION WITH MAGNET ON VERTICAL METAL SURFACE

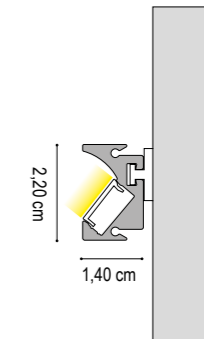

INSTALLAZIONE CON STAFFA PER INCASSO A CARTONGESSO
INSTALLATION WITH BRACKET FOR RECESSED PLASTERBOARD

ATTENZIONE! GLI ACCESSORI PER L'INSTALLAZIONE A INCASSO SONO STATI DIMENSIONATI PER UN PANNELLO STANDARD IN CARTONGESSO DI SPESSORE 12,5 mm
WARNING! THE BUILT-IN INSTALLATION ACCESSORIES HAVE BEEN DIMENSIONED FOR A STANDARD PLASTERBOARD PANEL OF 12.5 mm THICKNESS

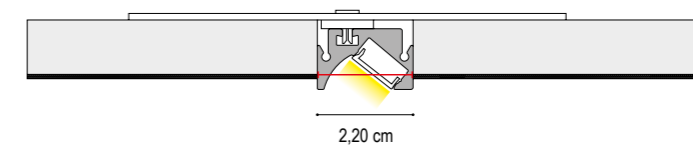

INSTALLAZIONE AD INCASSO
LARGHEZZA TAGLIO L=2,20cm
RECESSED INSTALLATION
CUTTING WIDTH L=3,50 cm

INSTALLAZIONE AD INCASSO CON CLIP NELLA MENSOLA
BUILT-IN INSTALLATION WITH SHELF IN POLYCARBONATE



INSTALLAZIONE SEMI INCASSO CON CLIP NELLA MENSOLA
SEMI BUILT-IN INSTALLATION WITH SHELF

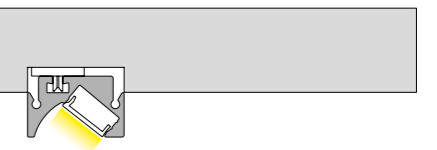

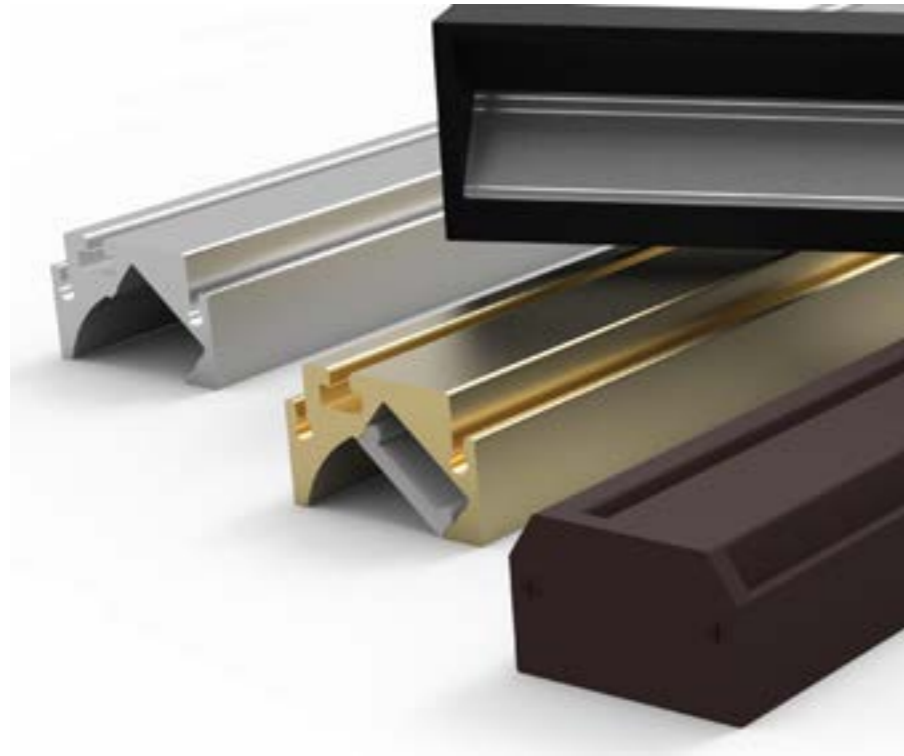

È POSSIBILE RICHIEDERE LA REALIZZAZIONE DI COMPOSIZIONI ANGOLARI CON ANGOLO DI AMPIEZZA DIVERSA DA 90°.
OGNI RICHIESTA DEVE PERVENIRE AL NOSTRO REPARTO TECNICO CORREDATA DA SCHEMA ILLUSTRATIVO.

IT IS POSSIBLE TO REQUEST THE CREATION OF ANGULAR COMPOSITIONS WITH AN ANGLE OF DIFFERENT 90°.
EVERY REQUEST MUST COME TO OUR TECHNICAL DEPARTMENT WITH ILLUSTRATIVE DIAGRAM.

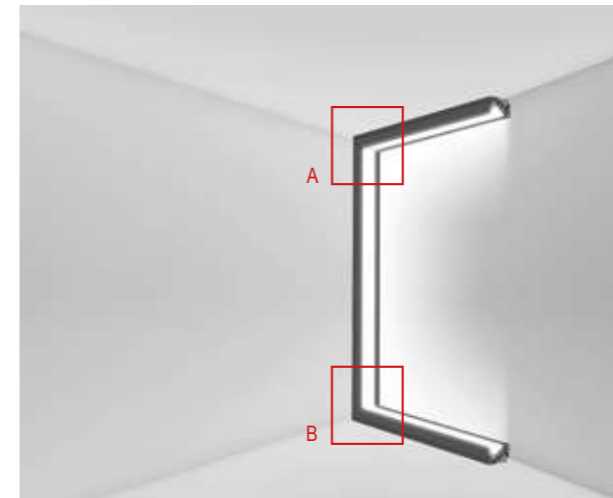

A) TAGLIO ANGOLARE - SOFFITTO/PARETE - TIPO A
A) CORNER CUT - CEILING / WALL - TYPE A
CODICE ARTICOLO / ITEM NUMBER: 190A

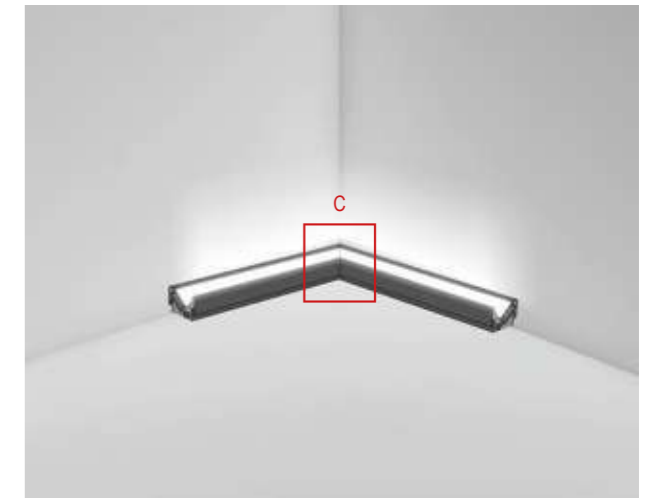

C) TAGLIO ANGOLARE - SUPERFICIE ORIZZONTALE - TIPO C
C) CORNER CUT - HORIZONTAL SURFACE - TYPE C
CODICE ARTICOLO / ITEM NUMBER: 190C

B) TAGLIO ANGOLARE - PARETE/SUP-ORIZZONTALE - TIPO B
B) CORNER CUT - WALL / SUP-HORIZONTAL - TYPE B
CODICE ARTICOLO / ITEM NUMBER: 190B



D) TAGLIO ANGOLARE - SUPERFICIE ORIZZONTALE - TIPO D
D) CORNER CUT - HORIZONTAL SURFACE - TYPE D
CODICE ARTICOLO / ITEM NUMBER: 190D



E) TAGLIO ANGOLARE - SUPERFICIE ORIZZONTALE - TIPO E
E) CORNER CUT - HORIZONTAL SURFACE - TYPE E
CODICE ARTICOLO / ITEM NUMBER: 190E

Ic014

led integrato

integrated led

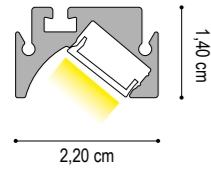
DATI TECNICI
TECHNICAL DATA

	1 cm	1 cm	1 cm
Nominal LED Flux:	1510 lm/m	1590 lm/m	1660 lm/m
Flux Tot:	1208 lm/m	1272 lm/m	1350 lm/m
Output:	110 lm/W	115 lm/W	120 lm/W
CCT:	2700 K	3000 K	4000 K
CRI:	>95	>95	>95
Power Tot:	14.4 W/m (160Led/m)	14.4 W/m (160 led/m)	14.4 W/m (160led/m)
Weight:	0.25 Kg/m	0.25 Kg/m	0.25 Kg/m

Alluminio/aluminum
Cover: Opale/opal

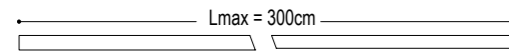

DRIVER NON INCLUSO / NOT INCLUDED

CAVO ALIMENTAZIONE : 50 cm
ALIMENTATION CABLE : 50 cm

FINITURA STRUTTURA FINISHES	DIFFUSORE DIFFUSER	1 cm - 2700K	1 cm - 3000K	1 cm - 4000K
		CODICE CODE	CODICE CODE	CODICE CODE
GRIGIO VESUVIO ANTHRACITE	OPALE/OPAL	105G100001	105G200001	105G300001
ARGILLA CLAY		105G101001	105G201001	105G301001
ARGENTO OPACO MATT SILVER		105G102001	105G202001	105G302001
BIANCO INTONACO/WHITE		105G103001	105G203001	105G303001
NERO CARAVAGGIO BLACK		105G104001	105G204001	105G304001
MOKA MOCHA		105G105001	105G205001	105G305001
CROMO/CHROME		105G108001	105G208001	105G308001
ORO CALIFORNIA/GOLD		105G109001	105G209001	105G309001
ARAMEN COPPER		105G110001	105G210001	105G310001
ARGENTO COMETA/SILVER COMET		105G112001	105G212001	105G312001
OTTONE VENEZIANO BRASS		105G113001	105G213001	105G313001
TITANIO/TITANIUM		105G114001	105G214001	105G314001
BRONZO RIACI/RIACI BRONZE		105G115001	105G215001	105G315001
VERDE COSTA/GREEN COAST		105G116001	105G216001	105G316001
TERRA SENESE SENESE EARTH		105G117001	105G217001	105G317001

N.B./P.N.: LUNGHEZZA MASSIMA VERSIONE CROMO = 2,00 m / MAXIMUM LENGTH CHROME VERSION = 2.00 m
TESTATE DI CHIUSURA NON INCLUSE / DEAD ENDS NOT INCLUDED

Ic014

led integrato

integrated led

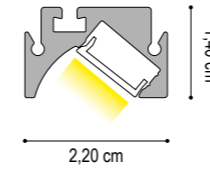
DATI TECNICI
TECHNICAL DATA

	1 cm	1 cm	1 cm
Nominal LED Flux:	1800 lm/m	1900 lm/m	2000 lm/m
Flux Tot:	1420 lm/m	1520 lm/m	1620 lm/m
Output:	150 lm/W	158 lm/W	166 lm/W
CCT:	2700 K	3000 K	4000 K
CRI:	>90	>90	>90
Power Tot:	12 W/m	12 W/m	12 W/m
Weight:	0.20 Kg/m	0.20 Kg/m	0.20 Kg/m

Alluminio/aluminum
Cover: Opale/opal

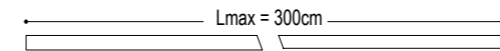

DRIVER NON INCLUSO / NOT INCLUDED

CAVO ALIMENTAZIONE : 50 cm
ALIMENTATION CABLE : 50 cm

FINITURA STRUTTURA FINISHES	DIFFUSORE DIFFUSER	1 cm - 2700K	1 cm - 3000K	1 cm - 4000K
		CODICE CODE	CODICE CODE	CODICE CODE
GRIGIO VESUVIO ANTHRACITE	OPALE/OPAL	1055400001	1055500001	1055600001
ARGILLA CLAY		1055401001	1055501001	1055601001
ARGENTO OPACO MATT SILVER		1055402001	1055502001	1055602001
BIANCO INTONACO/WHITE		1055403001	1055503001	1055603001
NERO CARAVAGGIO BLACK		1055404001	1055504001	1055604001
MOKA MOCHA		1055405001	1055505001	1055605001
CROMO/CHROME		1055408001	1055508001	1055608001
ORO CALIFORNIA/GOLD		1055409001	1055509001	1055609001
ARAMEN COPPER		1055410001	1055510001	1055610001
ARGENTO COMETA/SILVER COMET		1055412001	1055512001	1055612001
OTTONE VENEZIANO BRASS		1055413001	1055513001	1055613001
TITANIO/TITANIUM		1055414001	1055514001	1055614001
BRONZO RIACI/RIACI BRONZE		1055415001	1055515001	1055615001
VERDE COSTA/GREEN COAST		1055416001	1055516001	1055616001
TERRA SENESE SENESE EARTH		1055417001	1055517001	1055617001

N.B./P.N.: LUNGHEZZA MASSIMA VERSIONE CROMO = 2,00 m / MAXIMUM LENGTH CHROME VERSION = 2.00 m
TESTATE DI CHIUSURA NON INCLUSE / DEAD ENDS NOT INCLUDED

Ic014

led integrato

integrated led

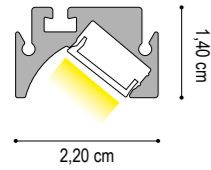
DATI TECNICI
TECHNICAL DATA

	1 cm	1 cm	1 cm
Nominal LED Flux:	1540 lm/m	1610 lm/m	1750 lm/m
Flux Tot:	1230 lm/m	1290 lm/m	1400 lm/m
Output:	110 lm/W	110 lm/W	110 lm/W
CCT:	2700 K	3000 K	4000 K
CRI:	>90	>90	>90
Power Tot:	14.4 W/m (240 Led/m)	14.4 W/m (240 Led/m)	14.4 W/m (240 Led/m)
Weight:	0.25 Kg/m	0.25 Kg/m	0.25 Kg/m

Alluminio/aluminum

Cover: Opale/opal

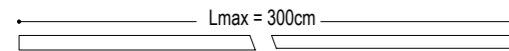

DRIVER NON INCLUSO / NOT INCLUDED

CAVO ALIMENTAZIONE : 50 cm
ALIMENTATION CABLE : 50 cm

FINITURA STRUTTURA FINISHES	DIFFUSORE DIFFUSER	1 cm - 2700K CODICE CODE	1 cm - 3000K CODICE CODE	1 cm - 4000K CODICE CODE
GRIGIO VESUVIO ANTHRACITE		105N200001	105N300001	105N400001
ARGILLA CLAY		105N201001	105N301001	105N401001
ARGENTO OPACO/MATT SILVER		105N202001	105N302001	105N402001
BIANCO INTONACO/WHITE		105N203001	105N303001	105N403001
NERO CARAVAGGIO BLACK		105N204001	105N304001	105N404001
MOKA MOCHA		105N205001	105N305001	105N405001
CROMO/CHROME		105N208001	105N308001	105N408001
ORO CALIFORNIA/GOLD	OPALE/OPAL	105N209001	105N309001	105N409001
ARAMEN COPPER		105N210001	105N310001	105N410001
ARGENTO COMETA/SILVER COMET		105N212001	105N312001	105N412001
OTTONE VENEZIANO/BRASS		105N213001	105N313001	105N413001
TITANIO/TITANIUM		105N214001	105N314001	105N414001
BRONZO RIACI/RIACI BRONZE		105N215001	105N315001	105N415001
VERDE COSTA/GREEN COAST		105N216001	105N316001	105N416001
TERRA SENESE/SENESE EARTH		105N217001	105N317001	105N417001

N.B./P.N.: LUNGHEZZA MASSIMA VERSIONE CROMO = 2,00 m / MAXIMUM LENGTH CHROME VERSION = 2.00 m
TESTATE DI CHIUSURA NON INCLUSE / DEAD ENDS NOT INCLUDED

Ic014

led integrato

integrated led

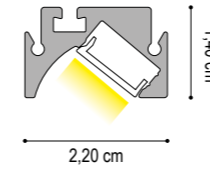
DATI TECNICI
TECHNICAL DATA

	1 cm	1 cm	1 cm
Nominal LED Flux:	2100 lm/m	2200 lm/m	2300 lm/m
Flux Tot:	1660 lm/m	1760 lm/m	1860 lm/m
Output:	105 lm/W	110 lm/W	115 lm/W
CCT:	2700 K	3000 K	4000 K
CRI:	>90	>90	>90
Power Tot:	20.0 W/m	20.0 W/m	20.0 W/m
Weight:	0.40 Kg/m	0.40 Kg/m	0.40 Kg/m

Alluminio/aluminum

Cover: Opale/opal

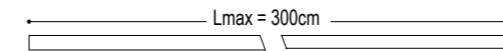

DRIVER NON INCLUSO / NOT INCLUDED

CAVO ALIMENTAZIONE : 50 cm
ALIMENTATION CABLE : 50 cm

FINITURA STRUTTURA FINISHES	DIFFUSORE DIFFUSER	1 cm - 2700K CODICE CODE	1 cm - 3000K CODICE CODE	1 cm - 4000K CODICE CODE
GRIGIO VESUVIO ANTHRACITE		1052500001	1052600001	1052700001
ARGILLA CLAY		1052501001	1052601001	1052701001
ARGENTO OPACO/MATT SILVER		1052502001	1052602001	1052702001
BIANCO INTONACO/WHITE		1052503001	1052603001	1052703001
NERO CARAVAGGIO BLACK		1052504001	1052604001	1052704001
MOKA MOCHA		1052505001	1052605001	1052705001
CROMO/CHROME		1052508001	1052608001	1052708001
ORO CALIFORNIA/GOLD	OPALE/OPAL	1052509001	1052609001	1052709001
ARAMEN COPPER		1052510001	1052610001	1052710001
ARGENTO COMETA/SILVER COMET		1052512001	1052612001	1052712001
OTTONE VENEZIANO/BRASS		1052513001	1052613001	1052713001
TITANIO/TITANIUM		1052514001	1052614001	1052714001
BRONZO RIACI/RIACI BRONZE		1052515001	1052615001	1052715001
VERDE COSTA/GREEN COAST		1052516001	1052616001	1052716001
TERRA SENESE/SENESE EARTH		1052517001	1052617001	1052717001

N.B./P.N.: LUNGHEZZA MASSIMA VERSIONE CROMO = 2,00 m / MAXIMUM LENGTH CHROME VERSION = 2.00 m
TESTATE DI CHIUSURA NON INCLUSE / DEAD ENDS NOT INCLUDED

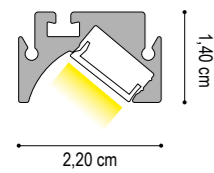

	1 cm	1 cm	1 cm
Nominal LED Flux:	1490 lm/m	1560 lm/m	1630 lm/m
Flux Tot:	1178 lm/m	1248 lm/m	1318 lm/m
Output:	124 lm/W	130 lm/W	136 lm/W
CCT:	2700 K	3000 K	4000 K
CRI:	>97	>97	>97
Power Tot:	12.0 W/m	12.0 W/m	12.0 W/m
Weight:	0.20 Kg/m	0.20 Kg/m	0.20 Kg/m

Alluminio/aluminum
Cover: Opale/opal

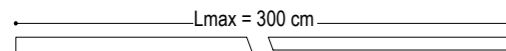

DRIVER NON INCLUSO / NOT INCLUDED

CAVO ALIMENTAZIONE : 50 cm
ALIMENTATION CABLE : 50 cm

FINITURA STRUTTURA FINISHES	DIFFUSORE DIFFUSER	1 cm - 2700K	1 cm - 3000K	1 cm - 4000K
		CODICE CODE	CODICE CODE	CODICE CODE
GRIGIO VESUVIO ANTHRACITE	OPALE/OPAL	1059600001	1059700001	1059800001
ARGILLA CLAY		1059601001	1059701001	1059801001
ARGENTO OPACO/MATT SILVER		1059602001	1059702001	1059802001
BIANCO INTONACO/WHITE		1059603001	1059703001	1059803001
NERO CARAVAGGIO BLACK		1059604001	1059704001	1059804001
MOKA MOCHA		1059605001	1059705001	1059805001
CROMO/CHROME		1059608001	1059708001	1059808001
ORO CALIFORNIA/GOLD		1059609001	1059709001	1059809001
ARAMEN COPPER		1059610001	1059710001	1059810001
ARGENTO COMETA/SILVER COMET		1059612001	1059712001	1059812001
OTTONE VENEZIANO/BRASS		1059613001	1059713001	1059813001
TITANIO/TITANIUM		1059614001	1059714001	1059814001
BRONZO RIACI/RIACI BRONZE		1059615001	1059715001	1059815001
VERDE COSTA/GREEN COAST		1059616001	1059716001	1059816001
TERRA SENESE/SENESE EARTH		1059617001	1059717001	1059817001

N.B./P.N.: LUNGHEZZA MASSIMA VERSIONE CROMO = 2,00 m / MAXIMUM LENGTH CHROME VERSION = 2.00 m
TESTATE DI CHIUSURA NON INCLUSE / DEAD ENDS NOT INCLUDED

LED compatibili / LED compatibility

HIGH QUALITY CRI>90 CRI>95	HIGH OUTPUT CRI>90 CRI>95	HIGH EFFICIENT CRI>90 CRI>95	HIGH INTENSITY CRI>90 CRI>95	LOW POWER CRI>90	ULTRA SLIM CRI>90 CRI>95 CRI>97	RGB	RGB WHITE	RGB TW	TUNABLE WHITE
9,6W 14,4W 19,2W	12,3W 14,4W 19,2W 20W 24W	11,0W 12,3W 14,4W 19,2W 20W 24W	24W (700 LED)	6W	7,0W 9,6W 12W 14,4W	14W	14W	14,4W 23W	19,2W

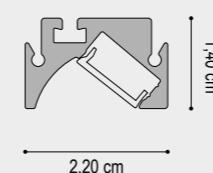

Diffusore in policarbonato
Polycarbonate diffuser

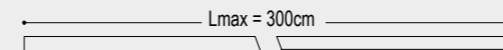

FINITURA STRUTTURA FINISHES	DIFFUSORE DIFFUSER	1 cm	200 cm	300 cm
		CODICE CODE	CODICE CODE	CODICE CODE
GRIGIO VESUVIO ANTHRACITE	OPALE/OPAL	105CP00001	105CP00200	105CP00300
ARGILLA CLAY		105CP01001	105CP01200	105CP01300
ARGENTO OPACO/MATT SILVER		105CP02001	105CP02200	105CP02300
BIANCO INTONACO/WHITE		105CP03001	105CP03200	105CP03300
NERO CARAVAGGIO BLACK		105CP04001	105CP04200	105CP04300
MOKA MOCHA		105CP05001	105CP05200	105CP05300
ALLUMINIO NATURALE/ALUMINUM		105CP06001	105CP06200	105CP06300
ORO CALIFORNIA/GOLD		105CP09001	105CP09200	105CP09300
ARAMEN COPPER		105CP10001	105CP10200	105CP10300
ARGENTO COMETA/SILVER COMET		105CP12001	105CP12200	105CP12300
OTTONE VENEZIANO/BRASS		105CP13001	105CP13200	105CP13300
TITANIO/TITANIUM		105CP14001	105CP14200	105CP14300
BRONZO RIACI/RIACI BRONZE		105CP15001	105CP15200	105CP15300
VERDE COSTA/GREEN COAST		105CP16001	105CP16200	105CP16300
TERRA SENESE/SENESE EARTH		105CP17001	105CP17200	105CP17300
CROMO/CHROME	105CP08001	105CP08200		

N.B./P.N.: LUNGHEZZA MASSIMA VERSIONE CROMO = 2,00 m / MAXIMUM LENGTH CHROME VERSION = 2.00 m
TESTATE DI CHIUSURA NON INCLUSE / DEAD ENDS NOT INCLUDED

LED compatibili / LED compatibility **NEW**

48V ONE CHIP CUT CRI>90 CRI>95	TWO CHIPS CUT CRI>90 CRI>95	SLIM ONE CHIP CUT CRI>90 CRI>95
8,0W 12,0W 19,2W	14,4W 24,0W	7,0W 9,0W 19,2W



Diffusore in policarbonato
Polycarbonate diffuser

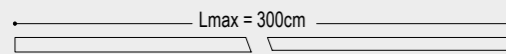
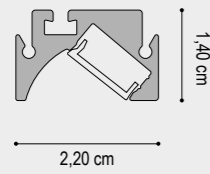

FINITURA STRUTTURA FINISHES	DIFFUSORE DIFFUSER	CODICE CODE		
		1 cm	200 cm	300 cm
GRIGIO VESUVIO ANTHRACITE	SATINATA/SATIN	105CS00001	105CS00200	105CS00300
ARGILLA CLAY		105CS01001	105CS01200	105CS01300
ARGENTO OPACO MATT SILVER		105CS02001	105CS02200	105CS02300
BIANCO INTONACO/WHITE		105CS03001	105CS03200	105CS03300
NERO CARAVAGGIO BLACK		105CS04001	105CS04200	105CS04300
MOKA MOCHA		105CS05001	105CS05200	105CS05300
ALLUMINIO NATURALE ALUMINUM		105CS06001	105CS06200	105CS06300
ORO CALIFORNIA/GOLD		105CS09001	105CS09200	105CS09300
ARAMEN COPPER		105CS10001	105CS10200	105CS10300
ARGENTO COMETA/SILVER COMET		105CS12001	105CS12200	105CS12300
OTTONE VENEZIANO BRASS		105CS13001	105CS13200	105CS13300
TITANIO/TITANIUM		105CS14001	105CS14200	105CS14300
BRONZO RIACI/RIACI BRONZE		105CS15001	105CS15200	105CS15300
VERDE COSTA/GREEN COAST		105CS16001	105CS16200	105CS16300
TERRA SENESE SENESE EARTH		105CS17001	105CS17200	105CS17300
CROMO/CHROME		105CS08001	105CS08200	

N.B./P.N.: LUNGHEZZA MASSIMA VERSIONE CROMO = 2,00 m / MAXIMUM LENGTH CHROME VERSION = 2.00 m
TESTATE DI CHIUSURA NON INCLUSE / DEAD ENDS NOT INCLUDED

Diffusore in policarbonato
Polycarbonate diffuser

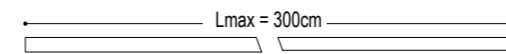
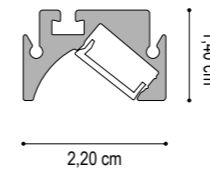

FINITURA STRUTTURA FINISHES	DIFFUSORE DIFFUSER	CODICE CODE		
		1 cm	200 cm	300 cm
GRIGIO VESUVIO ANTHRACITE	ECLISSI ECLIPSE	105CE00001	105CE00200	105CE00300
ARGILLA CLAY		105CE01001	105CE01200	105CE01300
ARGENTO OPACO MATT SILVER		105CE02001	105CE02200	105CE02300
BIANCO INTONACO/WHITE		105CE03001	105CE03200	105CE03300
NERO CARAVAGGIO BLACK		105CE04001	105CE04200	105CE04300
MOKA MOCHA		105CE05001	105CE05200	105CE05300
ALLUMINIO NATURALE ALUMINUM		105CE06001	105CE06200	105CE06300
ORO CALIFORNIA/GOLD		105CE09001	105CE09200	105CE09300
ARAMEN COPPER		105CE10001	105CE10200	105CE10300
ARGENTO COMETA/SILVER COMET		105CE12001	105CE12200	105CE12300
OTTONE VENEZIANO BRASS		105CE13001	105CE13200	105CE13300
TITANIO/TITANIUM		105CE14001	105CE14200	105CE14300
BRONZO RIACI/RIACI BRONZE		105CE15001	105CE15200	105CE15300
VERDE COSTA/GREEN COAST		105CE16001	105CE16200	105CE16300
TERRA SENESE SENESE EARTH		105CE17001	105CE17200	105CE17300
CROMO/CHROME		105CE08001	105CE08200	

N.B./P.N.: LUNGHEZZA MASSIMA VERSIONE CROMO = 2,00 m / MAXIMUM LENGTH CHROME VERSION = 2.00 m
TESTATE DI CHIUSURA NON INCLUSE / DEAD ENDS NOT INCLUDED

PROFILO LC014 CON DIFFUSORE
ECLISSI. SI RIDUCE L'ABBAGLIAMENTO
E L'EFFETTO PUNTINATO.

PROFILE LC014 WITH ECLIPSE
DIFFUSER. THE CLOTHING AND THE
SPOTTED EFFECT ARE REDUCED.



TESTATE DI CHIUSURA / DEAD ENDS

FINITURA STRUTTURA FINISHES	CODICE CODE	FINITURA STRUTTURA FINISHES	CODICE CODE
GRIGIO VESUVIO ANTHRACITE	1050400000	ORO CALIFORNIA/GOLD	1050409000
ARGILLA CLAY	1050401000	ARAMEN COPPER	1050410000
ARGENTO OPACO/MATT SILVER	1050402000	ARGENTO COMETA/SILVER COMET	1050412000
BIANCO INTONACO/WHITE	1050403000	OTTONE VENEZIANO BRASS	1050413000
NERO CARAVAGGIO BLACK	1050404000	TITANIO/TITANIUM	1050414000
MOKA MOCHA	1050405000	BRONZO RIACI/RIACI BRONZE	1050415000
ALLUMINIO NATURALE/ALUMINUM	1050406000	VERDE COSTA/GREEN COAST	1050416000
CROMO CHROME	1050408000	TERRA SENESE SENESE EARTH	1050417000

Il codice contiene 1 testata di chiusura con viti.
The code contains 1 closing warhead with screws.

GIUNTI / JOINTS

	FINITURA FINISHES	CODICE CODE
GIUNTO LINEA CONTINUA / STRAIGHT JOINT Accessorio per giunzioni meccaniche lineari Accessory for linear mechanical joints	ALLUMINIO NATURALE/ALUMINUM	1010500006
GIUNTO 90° ORIZZONTALE / HORIZONTAL JOINT 90° Accessorio per giunzioni meccaniche con angolo 90° Accessory for linear mechanical joints with 90° angle	ALLUMINIO NATURALE/ALUMINUM	1010500005
GIUNTO 90° VERTICALE / VERTICAL JOINT 90° Accessorio per giunzioni meccaniche con angolo 90° Accessory for linear mechanical joints with 90° angle	ALLUMINIO NATURALE/ALUMINUM	1010500007

Il codice contiene i grani per il fissaggio del giunto.
The code contains the grains to fix the joint.

INTERRUTTORE DIMMERABILE+INSTALLAZIONE / DIMMABLE SWITCH+INSTALLATION

DATI TECNICI TECHNICAL DATA	FINITURA STRUTTURA FINISHES	CODICE CODE
Accessorio che consente l'accensione e lo spegnimento dei LED e, a seconda della pressione, la regolazione dell'intensità luminosa. Accessory that allows the switching on and off of the LEDs and, depending on the pressure, the regulation of the light intensity. Tensione di alimentazione: 12-24V DC Supply voltage: 12-24V DC Corrente d'uscita: 4A max Output current: 4A max ON / OFF: contact < 0.7 s DIMMER: contact > 0.7 s	ALLUMINIO NATURALE/ALUMINUM	98244

STAFFA DI FISSAGGIO A DOPPIO ATTACCO / DOUBLE MOUNTING CLIP CALAMITA / MAGNET

FINITURA FINISHES	CODICE CODE	CODICE CODE	PORTATA RANGE
SUPERFICI PIANE 2mm EVEN SURFACE 2mm	1020500005	1020500010	1 Kg
SUPERFICI IRREGOLARI 3,9mm UNEVEN SURFACE 3,9mm	1020500006	1020500210	2 Kg

Accessorio per fissaggio a plafone/superficie. Quantità raccomandata: 1 pz ogni 50 cm di modello.

Ceiling/surface mounting accessory. Recommended quantity 1 pc every 50 cm of model.

Quantità raccomandata: 1 pz ogni 25 cm di modello.

Recommended quantity: 1 pc every 25 cm of model.

STAFFA SEMINCASSO PER CARTONGESSO / SEMI-BASED BRACKET FOR PLASTERBOARD

DATI TECNICI TECHNICAL DATA	FINITURA STRUTTURA FINISHES	CODICE CODE
Accessorio che consente l'incasso del modello. Accessory that allows the collection of the model. Nel codice sono comprese le viti per il fissaggio del modello alla staffa. The code includes screws for fixing the model to the bracket.	ALLUMINIO NATURALE/ALUMINUM	1090500001

LAVORAZIONI / PROCESSING

Ic014 + Ic021

DATI TECNICI TECHNICAL DATA	CODICE CODE
TAGLIO ANGOLARE 90° (PER ANGOLI FORMATI DA DUE PROFILI) TIPO A 90° CORNER CUT (FOR CORNERS MADE OF TWO PROFILES) - TYPE A	190A
TAGLIO ANGOLARE 90° (PER ANGOLI FORMATI DA DUE PROFILI) TIPO B 90° CORNER CUT (FOR CORNERS MADE OF TWO PROFILES) - TYPE B	190B
TAGLIO ANGOLARE 90° (PER ANGOLI FORMATI DA DUE PROFILI) TIPO C 90° CORNER CUT (FOR CORNERS MADE OF TWO PROFILES) - TYPE C	190C
TAGLIO ANGOLARE 90° (PER ANGOLI FORMATI DA DUE PROFILI) TIPO D 90° CORNER CUT (FOR CORNERS MADE OF TWO PROFILES) - TYPE D	190D
TAGLIO ANGOLARE 90° (PER ANGOLI FORMATI DA DUE PROFILI) TIPO E 90° CORNER CUT (FOR CORNERS MADE OF TWO PROFILES) - TYPE E	190E
TAGLIO ANGOLARE CUSTOM (PER ANGOLI FORMATI DA DUE PROFILI) CUSTOM CORNER CUT (FOR CORNERS MADE OF TWO PROFILES)	190N
ASOLA / SLOT	100A
FORO / HOLE	100F
CABLAGGIO - COLLAUDO - CE AL CENTIMETRO INSTALLATION AND TESTING LED MODULE AT CENTIMETER	1051
CONNETTORE MASCHIO/FEMMINA MALE/FEMALE CONNECTOR	98CFM
CONNETTORE MASCHIO/FEMMINA MONTATO NEL PRODOTTO MALE/FEMALE CONNECTOR FITTED IN THE PRODUCT	98MFM
CAVO DI ALIMENTAZIONE 2X0,50 BIANCO 1CM POWER CABLE 2X0,50 WHITE 1CM	98CB001
CAVO DI ALIMENTAZIONE 2X0,50 NERO 1CM POWER CABLE 2X0,50 BLACK 1CM	98CN001
CAVO DI ALIMENTAZIONE 2X0,75 MARRONE 1CM POWER CABLE 2X0,75 BROWN 1CM	98CS001

“prodotto estremamente versatile”

LC021 è il brillante risultato della nostra vocazione alla continua ricerca di soluzioni luminose che tendono a risolvere e soddisfare le esigenze illuminotecniche della nostra clientela. La finalità iniziale del nostro studio era quella di realizzare un prodotto estremamente versatile.

Il Design studiato per rendere possibile un'installazione da incasso, semi incasso o da parete. LC021 è la soluzione ideale per illuminare piccoli spazi come vetrine oppure ambienti più grandi usandolo anche come cornice luminosa a luce indiretta per valorizzare soffitti a volte oppure può essere utilizzata come luce diretta per illuminare sale, corridoi, ecc.

LC021 is the brilliant result of our vocation to the continuous search for lighting solutions that tend to solve and satisfy the lighting needs of our customers. The initial purpose of our study was to create an extremely versatile product. The Design studied to make a recessed, semi-recessed or wall-mounted installation possible. LC021 is the ideal solution to illuminate small spaces such as shop windows or larger environments, also using it as a luminous frame with indirect light to enhance vaulted ceilings or it can be used as direct light to illuminate halls, corridors, etc.





INSTALLAZIONE CON STAFFA PER INCASSO A CARTONGESSO
 INSTALLATION WITH BRACKET FOR RECESSED PLASTERBOARD

ATTENZIONE! IL PROFILO E GLI ACCESSORI SONO STATI DIMENSIONATI PER UN PANNELLO STANDARD IN CARTONGESSO DI SPESSORE 12,5 mm
 WARNING! PROFILE AND ACCESSORIES HAVE BEEN DIMENSIONED FOR A STANDARD PLASTERBOARD PANEL OF 12.5 mm THICKNESS

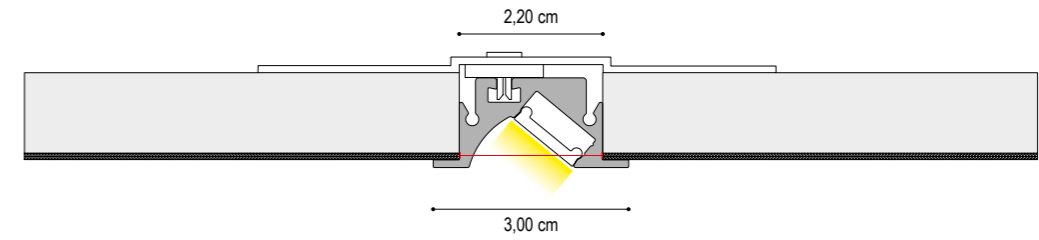

INSTALLAZIONE AD INCASSO
 LARGHEZZA TAGLIO L=2,20cm
 RECESSED INSTALLATION
 CUTTING WIDTH L=3,50 cm

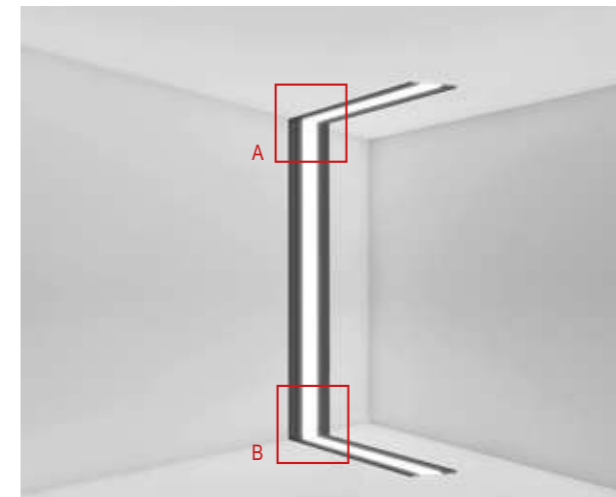

A) TAGLIO ANGOLARE - SOFFITTO/PARETE - TIPO A
 A) CORNER CUT - CEILING / WALL - TYPE A
 CODICE ARTICOLO / ITEM NUMBER: 190A

B) TAGLIO ANGOLARE - PARETE/SUP-ORIZZONTALE - TIPO B
 B) CORNER CUT - WALL / SUP-HORIZONTAL - TYPE B
 CODICE ARTICOLO / ITEM NUMBER: 190B

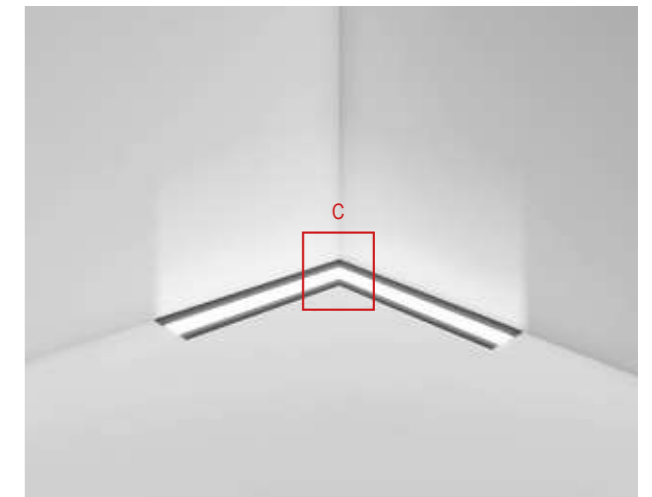

C) TAGLIO ANGOLARE - SUPERFICIE ORIZZONTALE - TIPO C
 C) CORNER CUT - HORIZONTAL SURFACE - TYPE C
 CODICE ARTICOLO / ITEM NUMBER: 190C

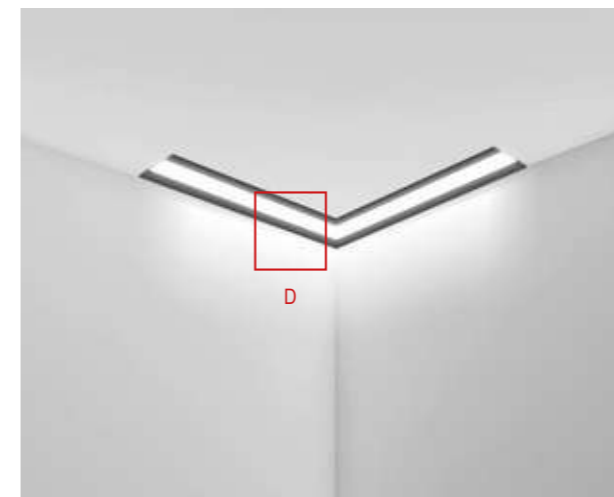

D) TAGLIO ANGOLARE - SUPERFICIE ORIZZONTALE - TIPO D
 D) CORNER CUT - HORIZONTAL SURFACE - TYPE D
 CODICE ARTICOLO / ITEM NUMBER: 190D

Ic021

led integrato

integrated led

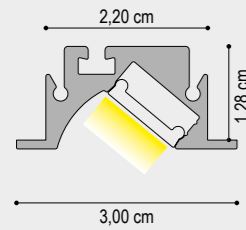
DATI TECNICI
TECHNICAL DATA

	1 cm	1 cm	1 cm
Nominal LED Flux:	1490 lm/m	1560 lm/m	1630 lm/m
Flux Tot:	1178 lm/m	1248 lm/m	1308 lm/m
Output:	124 lm/W	130 lm/W	136 lm/W
CCT:	2700 K	3000 K	4000 K
CRI:	>97 - R9>90	>97 - R9>90	>97 - R9>90
Power Tot:	12.0W/m	12.0W/m	12.0W/m
Weight:	0.20 Kg/m	0.20 Kg/m	0.20 Kg/m

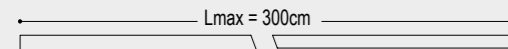
Alluminio/aluminum
Cover: Opale/opal

DRIVER NON INCLUSO / NOT INCLUDED

CAVO ALIMENTAZIONE : 50 cm
ALIMENTATION CABLE : 50 cm

FINITURA STRUTTURA FINISHES	DIFFUSORE DIFFUSER	1 cm - 2700K	1 cm - 3000K	1 cm - 4000K
		CODICE CODE	CODICE CODE	CODICE CODE
GRIGIO VESUVIO ANTHRACITE	OPALE/OPAL	149600001	149700001	149800001
ARGILLA CLAY		149601001	149701001	149801001
ARGENTO OPACO/MATT SILVER		149602001	149702001	149802001
BIANCO INTONACO/WHITE		149603001	149703001	149803001
NERO CARAVAGGIO BLACK		149604001	149704001	149804001
MOKA MOCHA		149605001	149705001	149805001
CROMO/CHROME		149608001	149708001	149808001
ORO CALIFORNIA/GOLD		149609001	149709001	149809001
ARAMEN COPPER		149610001	149710001	149810001
ARGENTO COMETA/SILVER COMET		149612001	149712001	149812001
OTTONE VENEZIANO/BRASS		149613001	149713001	149813001
TITANIO/TITANIUM		149614001	149714001	149814001
BRONZO RIACI/RIACI BRONZE		149615001	149715001	149815001
VERDE COSTA/GREEN COAST		149616001	149716001	149816001
TERRA SENESE/SENESE EARTH		149617001	149717001	149817001

N.B./P.N.: LUNGHEZZA MASSIMA VERSIONE CROMO = 2,00 m / MAXIMUM LENGTH CHROME VERSION = 2.00 m
TESTATE DI CHIUSURA NON INCLUSE / DEAD ENDS NOT INCLUDED

LED compatibili / LED compatibility

HIGH QUALITY CRI>90 CRI>95	HIGH OUTPUT CRI>90 CRI>95	HIGH EFFICIENT CRI>90 CRI>95	HIGH INTENSITY CRI>90 CRI>95	LOW POWER CRI>90	ULTRA SLIM CRI>90 CRI>95 CRI>97	RGB	RGB WHITE	RGB TW	TUNABLE WHITE
9,6W 14,4W 19,2W	12,3W 14,4W 19,2W 20W 24W	11,0W 12,3W 14,4W 19,2W 20W 24W	24W 24W (700 LED)	6W	7,0W 9,6W 12W 14,4W	14W	14W	14,4W 23W	19,2W

Ic021

led integrato

integrated led

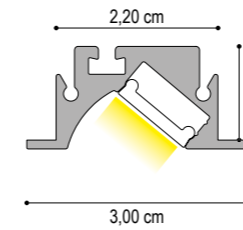
DATI TECNICI
TECHNICAL DATA

	1 cm	1 cm	1 cm
Nominal LED Flux:	2100 lm/m	2200 lm/m	2300 lm/m
Flux Tot:	1660 lm/m	1760 lm/m	1860 lm/m
Output:	105 lm/W	110 lm/W	115 lm/W
CCT:	2700 K	3000 K	4000 K
CRI:	>90	>90	>90
Power Tot:	20.0 W/m	20.0 W/m	20.0 W/m
Weight:	0.40 Kg/m	0.40 Kg/m	0.40 Kg/m

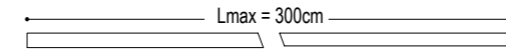
Alluminio/aluminum
Cover: Opale/opal

DRIVER NON INCLUSO / NOT INCLUDED

CAVO ALIMENTAZIONE : 50 cm
ALIMENTATION CABLE : 50 cm

FINITURA STRUTTURA FINISHES	DIFFUSORE DIFFUSER	1 cm - 2700K	1 cm - 3000K	1 cm - 4000K
		CODICE CODE	CODICE CODE	CODICE CODE
GRIGIO VESUVIO ANTHRACITE	OPALE/OPAL	142500001	142600001	142700001
ARGILLA CLAY		142501001	142601001	142701001
ARGENTO OPACO/MATT SILVER		142502001	142602001	142702001
BIANCO INTONACO/WHITE		142503001	142603001	142703001
NERO CARAVAGGIO BLACK		142504001	142604001	142704001
MOKA MOCHA		142505001	142605001	142705001
CROMO/CHROME		142508001	142608001	142708001
ORO CALIFORNIA/GOLD		142509001	142609001	142709001
ARAMEN COPPER		142510001	142610001	142710001
ARGENTO COMETA/SILVER COMET		142512001	142612001	142712001
OTTONE VENEZIANO/BRASS		142513001	142613001	142713001
TITANIO/TITANIUM		142514001	142614001	142714001
BRONZO RIACI/RIACI BRONZE		142515001	142615001	142715001
VERDE COSTA/GREEN COAST		142516001	142616001	142716001
TERRA SENESE/SENESE EARTH		142517001	142617001	142717001

N.B./P.N.: LUNGHEZZA MASSIMA VERSIONE CROMO = 2,00 m / MAXIMUM LENGTH CHROME VERSION = 2.00 m
TESTATE DI CHIUSURA NON INCLUSE / DEAD ENDS NOT INCLUDEDLED compatibili / LED compatibility **NEW**

48V ONE CHIP CUT CRI>90 CRI>95	TWO CHIPS CUT CRI>90 CRI>95	SLIM ONE CHIP CUT CRI>90 CRI>95
8,0W 12,0W 19,2W	14,4W 24,0W	7,0W 9,0W 19,2W



Ic021

led non integrato

not integrated led

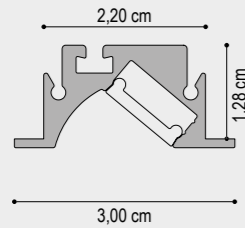
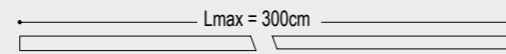
Diffusore in policarbonato
Polycarbonate diffuser

1 cm

200 cm

300 cm

FINITURA STRUTTURA
FINISHES

GRIGIO VESUVIO ANTHRACITE
ARGILLA CLAY
ARGENTO OPACO MATT SILVER
BIANCO INTONACO/WHITE
NERO CARAVAGGIO BLACK
MOKA MOCHA
ORO CALIFORNIA/GOLD
ARAMEN COPPER
ARGENTO COMETA/SILVER COMET
OTTONE VENEZIANO BRASS
TITANIO/TITANIUM
BRONZO RIACI/RIACI BRONZE
VERDE COSTA/GREEN COAST
TERRA SENESE SENESE EARTH
CROMO CHROME

DIFFUSORE
DIFFUSER

SATINATA/SATIN

CODICE
CODE

14CS00001
14CS01001
14CS02001
14CS03001
14CS04001
14CS05001
14CS09001
14CS10001
14CS12001
14CS13001
14CS14001
14CS15001
14CS16001
14CS17001
14CS08001

CODICE
CODE

14CS000200
14CS010200
14CS020200
14CS030200
14CS040200
14CS050200
14CS090200
14CS100200
14CS120200
14CS130200
14CS140200
14CS150200
14CS160200
14CS170200
14CS080200

CODICE
CODE

14CS000300
14CS010300
14CS020300
14CS030300
14CS040300
14CS050300
14CS090300
14CS100300
14CS120300
14CS130300
14CS140300
14CS150300
14CS160300
14CS170300

N.B./P.N.: LUNGHEZZA MASSIMA VERSIONE CROMO = 2,00 m / MAXIMUM LENGTH CHROME VERSION = 2.00 m
TESTATE DI CHIUSURA NON INCLUSE / DEAD ENDS NOT INCLUDED

1 cm

200 cm

300 cm

FINITURA STRUTTURA
FINISHES

GRIGIO VESUVIO ANTHRACITE
ARGILLA CLAY
ARGENTO OPACO MATT SILVER
BIANCO INTONACO/WHITE
NERO CARAVAGGIO BLACK
MOKA MOCHA
ORO CALIFORNIA/GOLD
ARAMEN COPPER
ARGENTO COMETA/SILVER COMET
OTTONE VENEZIANO BRASS
TITANIO/TITANIUM
BRONZO RIACI/RIACI BRONZE
VERDE COSTA/GREEN COAST
TERRA SENESE SENESE EARTH
CROMO CHROME

DIFFUSORE
DIFFUSER

OPALE/OPAL

CODICE
CODE

14CP00001
14CP01001
14CP02001
14CP03001
14CP04001
14CP05001
14CP09001
14CP10001
14CP12001
14CP13001
14CP14001
14CP15001
14CP16001
14CP17001
14CP08001

CODICE
CODE

14CP000200
14CP010200
14CP020200
14CP030200
14CP040200
14CP050200
14CP090200
14CP100200
14CP120200
14CP130200
14CP140200
14CP150200
14CP160200
14CP170200
14CP080200

CODICE
CODE

14CP000300
14CP010300
14CP020300
14CP030300
14CP040300
14CP050300
14CP090300
14CP100300
14CP120300
14CP130300
14CP140300
14CP150300
14CP160300
14CP170300

N.B./P.N.: LUNGHEZZA MASSIMA VERSIONE CROMO = 2,00 m / MAXIMUM LENGTH CHROME VERSION = 2.00 m
TESTATE DI CHIUSURA NON INCLUSE / DEAD ENDS NOT INCLUDED



Ic021

led non integrato

not integrated led

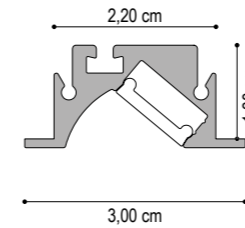
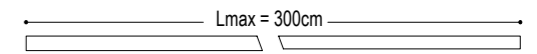
Diffusore in policarbonato
Polycarbonate diffuser

1 cm

200 cm

300 cm

FINITURA STRUTTURA
FINISHES

GRIGIO VESUVIO ANTHRACITE
ARGILLA CLAY
ARGENTO OPACO MATT SILVER
BIANCO INTONACO/WHITE
NERO CARAVAGGIO BLACK
MOKA MOCHA
ORO CALIFORNIA/GOLD
ARAMEN COPPER
ARGENTO COMETA/SILVER COMET
OTTONE VENEZIANO BRASS
TITANIO/TITANIUM
BRONZO RIACI/RIACI BRONZE
VERDE COSTA/GREEN COAST
TERRA SENESE SENESE EARTH
CROMO CHROME

DIFFUSORE
DIFFUSER

ECLISSI ECLIPSE

CODICE
CODE

14CE00001
14CE01001
14CE02001
14CE03001
14CE04001
14CE05001
14CE09001
14CE10001
14CE12001
14CE13001
14CE14001
14CE15001
14CE16001
14CE17001
14CE08001

CODICE
CODE

14CE000200
14CE010200
14CE020200
14CE030200
14CE040200
14CE050200
14CE090200
14CE100200
14CE120200
14CE130200
14CE140200
14CE150200
14CE160200
14CE170200
14CE080200

CODICE
CODE

14CE000300
14CE010300
14CE020300
14CE030300
14CE040300
14CE050300
14CE090300
14CE100300
14CE120300
14CE130300
14CE140300
14CE150300
14CE160300
14CE170300

N.B./P.N.: LUNGHEZZA MASSIMA VERSIONE CROMO = 2,00 m / MAXIMUM LENGTH CHROME VERSION = 2.00 m
TESTATE DI CHIUSURA NON INCLUSE / DEAD ENDS NOT INCLUDED

TESTATE DI CHIUSURA / DEAD ENDS

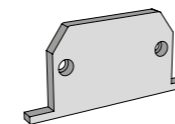
FINITURA STRUTTURA
FINISHES

GRIGIO VESUVIO ANTHRACITE
ARGILLA CLAY
ARGENTO OPACO MATT SILVER
BIANCO INTONACO/WHITE
NERO CARAVAGGIO BLACK
MOKA MOCHA
CROMO CHROME
ORO CALIFORNIA/GOLD

CODICE
CODE

140400
140401
140402
140403
140404
140405
140408
140409

FINITURA STRUTTURA
FINISHES

ARAMEN COPPER
ARGENTO COMETA/SILVER COMET
OTTONE VENEZIANO BRASS
TITANIO/TITANIUM
BRONZO RIACI/RIACI BRONZE
VERDE COSTA/GREEN COAST
TERRA SENESE SENESE EARTH

CODICE
CODE

140410
140412
140413
140414
140415
140416
140417

Il codice contiene 1 testata di chiusura con viti.
The code contains 1 closing warhead with screws.

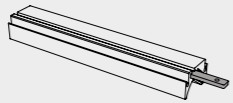
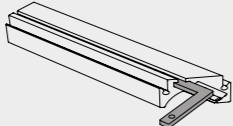
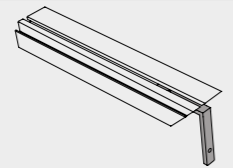

GIUNTI / JOINTS

		FINITURA FINISHES	CODICE CODE
GIUNTO LINEA CONTINUA / STRAIGHT JOINT Accessorio per giunzioni meccaniche lineari Accessory for linear mechanical joints		ALLUMINIO NATURALE/ALUMINUM	1010500006
GIUNTO 90° ORIZZONTALE / HORIZONTAL JOINT 90° Accessorio per giunzioni meccaniche con angolo 90° Accessory for linear mechanical joints with 90° angle		ALLUMINIO NATURALE/ALUMINUM	1010500005
GIUNTO 90° VERTICALE / VERTICAL JOINT 90° Accessorio per giunzioni meccaniche con angolo 90° Accessory for linear mechanical joints with 90° angle		ALLUMINIO NATURALE/ALUMINUM	1010500007



Il codice contiene i grani per il fissaggio del giunto.
The code contains the grains to fix the joint.

INTERRUTTORE DIMMERABILE+INSTALLAZIONE / DIMMABLE SWITCH+INSTALLATION

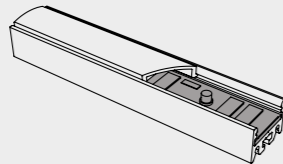
DATI TECNICI TECHNICAL DATA	FINITURA STRUTTURA FINISHES	CODICE CODE
Accessorio che consente l'accensione e lo spegnimento dei LED e, a seconda della pressione, la regolazione dell'intensità luminosa. Accessory that allows the switching on and off of the LEDs and, depending on the pressure, the regulation of the light intensity. Tensione di alimentazione: 12-24V DC Supply voltage: 12-24V DC Corrente d'uscita: 4A max Output current: 4A max ON / OFF: contact < 0.7 s DIMMER: contact > 0.7 s	ALLUMINIO NATURALE/ALUMINUM	98244



STAFFA DI FISSAGGIO A DOPPIO ATTACCO / DOUBLE MOUNTING CLIP CALAMITA / MAGNET

	FINITURA FINISHES	CODICE CODE		CODICE CODE	PORTATA RANGE
	SUPERFICI PIANE 2mm EVEN SURFACE 2mm	1020500005		1020500010	1 Kg
	SUPERFICI IRREGOLARI 3,9mm UNEVEN SURFACE 3,9mm	1020500006		1020500210	2 Kg

Accessorio per fissaggio a plafone/superficie. Quantità raccomandata: 1 pz ogni 50 cm di modello.

Ceiling/surface mounting accessory. Recommended quantity 1 pc every 50 cm of model.

Quantità raccomandata: 1 pz ogni 25 cm di modello.

Recommended quantity: 1 pc every 25 cm of model.





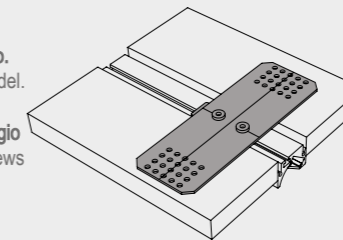

STAFFA SEMINCASSO PER CARTONGESSO / SEMI-BASED BRACKET FOR PLASTERBOARD

DATI TECNICI TECHNICAL DATA	FINITURA STRUTTURA FINISHES	CODICE CODE
Accessorio che consente l'incasso del modello. Accessory that allows the collection of the model. Nel codice sono comprese le viti per il fissaggio del modello alla staffa. The code includes screws for fixing the model to the bracket.	ALLUMINIO NATURALE/ALUMINUM	1090500001



LAVORAZIONI / PROCESSING

Ic014 + Ic021

	DATI TECNICI TECHNICAL DATA	CODICE CODE
	TAGLIO ANGOLARE 90° (PER ANGOLI FORMATI DA DUE PROFILI) TIPO A 90 ° CORNER CUT (FOR CORNERS MADE OF TWO PROFILES) - TYPE A	190A
	TAGLIO ANGOLARE 90° (PER ANGOLI FORMATI DA DUE PROFILI) TIPO B 90 ° CORNER CUT (FOR CORNERS MADE OF TWO PROFILES) - TYPE B	190B
	TAGLIO ANGOLARE 90° (PER ANGOLI FORMATI DA DUE PROFILI) TIPO C 90 ° CORNER CUT (FOR CORNERS MADE OF TWO PROFILES) - TYPE C	190C
	TAGLIO ANGOLARE 90° (PER ANGOLI FORMATI DA DUE PROFILI) TIPO D 90 ° CORNER CUT (FOR CORNERS MADE OF TWO PROFILES) - TYPE D	190D
	TAGLIO ANGOLARE 90° (PER ANGOLI FORMATI DA DUE PROFILI) TIPO E 90 ° CORNER CUT (FOR CORNERS MADE OF TWO PROFILES) - TYPE E	190E
	TAGLIO ANGOLARE CUSTOM (PER ANGOLI FORMATI DA DUE PROFILI) CUSTOM CORNER CUT (FOR CORNERS MADE OF TWO PROFILES)	190N
	ASOLA / SLOT	100A
	FORO / HOLE	100F
	CABLAGGIO - COLLAUDO - CE AL CENTIMETRO INSTALLATION AND TESTING LED MODULE AT CENTIMETER	1051
	CONNETTORE MASCHIO/FEMMINA MALE/FEMALE CONNECTOR	98CFM
	CONNETTORE MASCHIO/FEMMINA MONTATO NEL PRODOTTO MALE/FEMALE CONNECTOR FITTED IN THE PRODUCT	98MFM
	CAVO DI ALIMENTAZIONE 2X0,50 BIANCO 1CM POWER CABLE 2X0,50 WHITE 1CM	98CB001
	CAVO DI ALIMENTAZIONE 2X0,50 NERO 1CM POWER CABLE 2X0,50 BLACK 1CM	98CN001
	CAVO DI ALIMENTAZIONE 2X0,75 MARRONE 1CM POWER CABLE 2X0,75 BROWN 1CM	98CS001

**“design minimalista
dimensioni ridotte”**

Il tema su cui si è svolto lo studio del progetto SC015 era quello di creare un prodotto in grado di direzionare la luce in maniera precisa e puntuale.

Il suo design estremamente minimalista le sue dimensioni ridottissime lo rendono un prodotto molto flessibile adatto ad essere posizionato in tutti gli angoli anche con dimensioni ridotte, questo ci permette di realizzare un segmento di Luce sia verticale che orizzontale ben distribuito ed omogeneo contribuendo ad esaltarne le scene espositive.

The idea to project SC015 is born with the need to have a profile which is able to direct the light precisely and punctually.

The design extremely minimal and dimensions very small, allows to have a very flexible installation and to put it also in very reduced angles.

Therefore offers the possibility to project a light segment vertically or horizontally with homogeny effects directed on the expositive scenes.





INSTALLAZIONE SU SUPERFICIE ORIZZONTALI E VERTICALI
INSTALLATION ON HORIZONTAL AND VERTICAL SURFACES



IL PRODOTTO SC015 NON PREVEDE ACCESSORI PER L'INSTALLAZIONE. IL FISSAGGIO A SUPERFICIE DEVE ESSERE REALIZZATO MEDIANTE APPOSITI COLLANTI O NASTRO BIADESIVO. SI RACCOMANDA DI SCEGLIERE IL METODO DI FISSAGGIO ADATTO ALLA SUPERFICIE DI INSTALLAZIONE.

THE SC015 PRODUCT DOES NOT PROVIDE ACCESSORIES FOR INSTALLATION. SURFACE MOUNTING MUST BE MADE USING SPECIAL ADHESIVES OR DOUBLE-SIDED TAPE. IT IS RECOMMENDED TO CHOOSE THE FASTENING METHOD SUITABLE FOR THE INSTALLATION SURFACE.

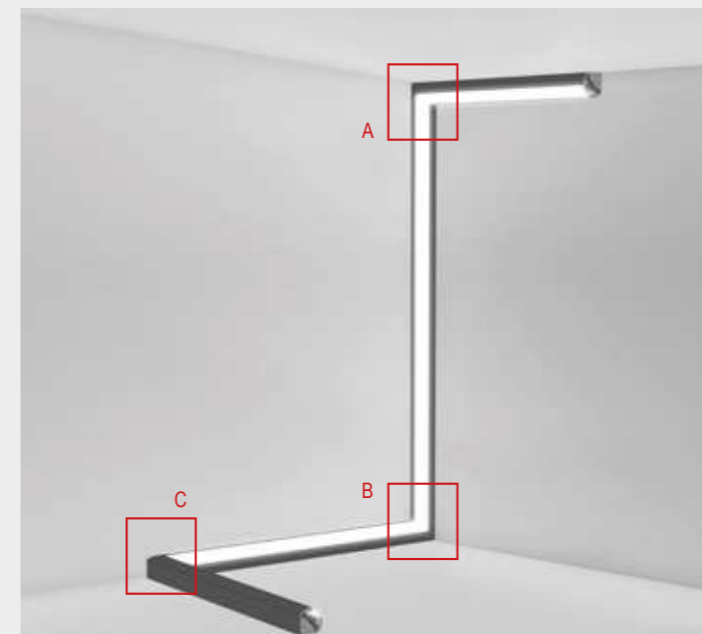
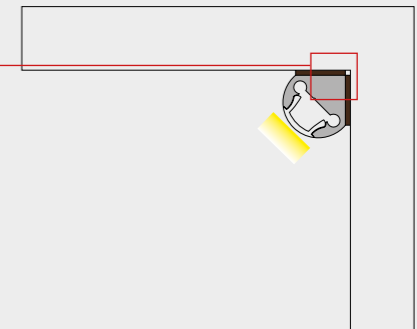

A) SUPERFICIE ORIZZONTALE / VERTICALER - ANGOLO 90° VERTICALE

A) HORIZONTAL / VERTICAL SURFACE - 90 ° VERTICAL ANGLE
CODICE ARTICOLO / ITEM NUMBER: 190Y

B) SUPERFICIE VERTICALE / ORIZZONTALE - ANGOLO 90° VERTICALE

B) VERTICAL / HORIZONTAL SURFACE - 90 ° VERTICAL ANGLE
CODICE ARTICOLO / ITEM NUMBER: 190Y

C) SUPERFICIE ORIZZONTALE - ANGOLO 90° ORIZZONTALE

C) HORIZONTAL SURFACE - 90 ° HORIZONTAL ANGLE
CODICE ARTICOLO / ITEM NUMBER: 190X

ANGOLO DIVERSO DA 90°
ANGLE DIFFERENT FROM 90 °

È POSSIBILE RICHIEDERE LA REALIZZAZIONE DI COMPOSIZIONI ANGOLARI CON ANGOLO DI AMPIEZZA DIVERSA DA 90°. OGNI RICHIESTA DEVE PERVENIRE AL NOSTRO REPARTO TECNICO CORREDATA DA SCHEMA ILLUSTRATIVO.

IT IS POSSIBLE TO REQUEST THE CREATION OF ANGULAR COMPOSITIONS WITH AN ANGLE OF DIFFERENT 90 °. EVERY REQUEST MUST COME TO OUR TECHNICAL DEPARTMENT WITH ILLUSTRATIVE DIAGRAM.

sc015

led integrato

integrated led

sc015

led integrato

integrated led

DATI TECNICI
TECHNICAL DATA



	1 cm	1 cm	1 cm
Nominal LED Flux:	1800 lm/m	1900 lm/m	1990 lm/m
Flux Tot:	1420 lm/m	1520 lm/m	1430 lm/m
Output:	150 lm/W	158 lm/W	166 lm/W
CCT:	2700 K	3000 K	4000 K
CRI:	>90	>90	>90
Power Tot:	12.0W/m	12.0W/m	12.0W/m
Weight:	0.20 Kg/m	0.20 Kg/m	0.20 Kg/m

Alluminio/aluminum
Cover: Opale/opal

DRIVER NON INCLUSO / NOT INCLUDED

CAVO ALIMENTAZIONE : 50 cm
ALIMENTATION CABLE : 50 cm

Lmax = 300cm

DATI TECNICI
TECHNICAL DATA



	1 cm	1 cm	1 cm
Nominal LED Flux:	1490 lm/m	1560 lm/m	1630 lm/m
Flux Tot:	1178 lm/m	1248 lm/m	1308 lm/m
Output:	124 lm/W	130 lm/W	136 lm/W
CCT:	2700 K	3000 K	4000 K
CRI:	>97 - R9>90	>97 - R9>90	>97 - R9>90
Power Tot:	12.0W/m	12.0W/m	12.0W/m
Weight:	0.20 Kg/m	0.20 Kg/m	0.20 Kg/m

Alluminio/aluminum
Cover: Opale/opal

Lmax = 300cm

FINITURA STRUTTURA
FINISHES

- GRIGIO VESUVIO ANTHRACITE
- ARGILLA CLAY
- ARGENTO OPACO/MATT SILVER
- BIANCO INTONACO/WHITE
- NERO CARAVAGGIO BLACK
- MOKA MOCHA
- CROMO/CHROME
- ORO CALIFORNIA/GOLD
- ARAMEN COPPER
- ARGENTO COMETA/SILVER COMET
- OTTONE VENEZIANO BRASS
- TITANIO/TITANIUM
- BRONZO RIACI/RIACI BRONZE
- VERDE COSTA/GREEN COAST
- TERRA SENESE SENESE EARTH

DIFFUSORE
DIFFUSER

OPALE/OPAL

1 cm - 2700K 1 cm - 3000K 1 cm - 4000K

CODICE CODE	CODICE CODE	CODICE CODE
1065400001	1065500001	1065600001
1065401001	1065501001	1065601001
1065402001	1065502001	1065602001
1065403001	1065503001	1065603001
1065404001	1065504001	1065604001
1065405001	1065505001	1065605001
1065408001	1065508001	1065608001
1065409001	1065509001	1065609001
1065410001	1065510001	1065610001
1065412001	1065512001	1065612001
1065413001	1065513001	1065613001
1065414001	1065514001	1065614001
1065415001	1065515001	1065615001
1065416001	1065516001	1065616001
1065417001	1065517001	1065617001

N.B./P.N.: LUNGHEZZA MASSIMA VERSIONE CROMO = 2,00 m / MAXIMUM LENGTH CHROME VERSION = 2.00 m
TESTATE DI CHIUSURA NON INCLUSE / DEAD ENDS NOT INCLUDED

FINITURA STRUTTURA
FINISHES

- GRIGIO VESUVIO ANTHRACITE
- ARGILLA CLAY
- ARGENTO OPACO/MATT SILVER
- BIANCO INTONACO/WHITE
- NERO CARAVAGGIO BLACK
- MOKA MOCHA
- CROMO/CHROME
- ORO CALIFORNIA/GOLD
- ARAMEN COPPER
- ARGENTO COMETA/SILVER COMET
- OTTONE VENEZIANO BRASS
- TITANIO/TITANIUM
- BRONZO RIACI/RIACI BRONZE
- VERDE COSTA/GREEN COAST
- TERRA SENESE SENESE EARTH

DIFFUSORE
DIFFUSER

OPALE/OPAL

1 cm - 2700K 1 cm - 3000K 1 cm - 4000K

CODICE CODE	CODICE CODE	CODICE CODE
1069600001	1069700001	1069800001
1069601001	1069701001	1069801001
1069602001	1069702001	1069802001
1069603001	1069703001	1069803001
1069604001	1069704001	1069804001
1069605001	1069705001	1069805001
1069608001	1069708001	1069808001
1069609001	1069709001	1069809001
1069610001	1069710001	1069810001
1069612001	1069712001	1069812001
1069613001	1069713001	1069813001
1069614001	1069714001	1069814001
1069615001	1069715001	1069815001
1069616001	1069716001	1069816001
1069617001	1069717001	1069817001

N.B./P.N.: LUNGHEZZA MASSIMA VERSIONE CROMO = 2,00 m / MAXIMUM LENGTH CHROME VERSION = 2.00 m
TESTATE DI CHIUSURA NON INCLUSE / DEAD ENDS NOT INCLUDED

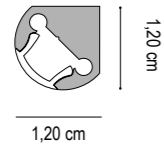

Diffusore in policarbonato
Polycarbonate diffuser

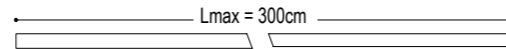

FINITURA STRUTTURA FINISHES	DIFFUSORE DIFFUSER	CODICE CODE		
		1 cm	200 cm	300 cm
GRIGIO VESUVIO ANTHRACITE		106CP00001	106CP00200	106CP00300
ARGILLA CLAY		106CP01001	106CP01200	106CP01300
ARGENTO OPACO MATT SILVER		106CP02001	106CP02200	106CP02300
BIANCO INTONACO/WHITE		106CP03001	106CP03200	106CP03300
NERO CARAVAGGIO BLACK		106CP04001	106CP04200	106CP04300
MOKA MOCHA		106CP05001	106CP05200	106CP05300
ORO CALIFORNIA/GOLD		106CP09001	106CP09200	106CP09300
ARAMEN COPPER	OPALE/OPAL	106CP10001	106CP10200	106CP10300
ARGENTO COMETA/SILVER COMET		106CP12001	106CP12200	106CP12300
OTTONE VENEZIANO BRASS		106CP13001	106CP13200	106CP13300
TITANIO/TITANIUM		106CP14001	106CP14200	106CP14300
BRONZO RIACI/RIACI BRONZE		106CP15001	106CP15200	106CP15300
VERDE COSTA/GREEN COAST		106CP16001	106CP16200	106CP16300
TERRA SENESE SENESE EARTH		106CP17001	106CP17200	106CP17300
CROMO/CHROME		106CP08001	106CP08200	106CP08300

N.B./P.N.: LUNGHEZZA MASSIMA VERSIONE CROMO = 2,00 m / MAXIMUM LENGTH CHROME VERSION = 2.00 m
TESTATE DI CHIUSURA NON INCLUSE / DEAD ENDS NOT INCLUDED

LED compatibili / LED compatibility **NEW**

ULTRA SLIM CRI>90 CRI>95 CRI>97	RGB SLIM	SLIM ONE CHIP
7,0W 9,6W 12W 14,4W	14,4W	7,0W 9,0W 19,2W



TESTATE DI CHIUSURA / DEAD ENDS



FINITURA STRUTTURA FINISHES	CODICE CODE	FINITURA STRUTTURA FINISHES	CODICE CODE
GRIGIO VESUVIO ANTHRACITE	1060400000	ARAMEN COPPER	1060410000
ARGILLA CLAY	1060401000	ARGENTO COMETA/SILVER COMET	1060412000
ARGENTO OPACO MATT SILVER	1060402000	OTTONE VENEZIANO BRASS	1060413000
BIANCO INTONACO/WHITE	1060403000	TITANIO/TITANIUM	1060414000
NERO CARAVAGGIO BLACK	1060404000	BRONZO RIACI/RIACI BRONZE	1060415000
MOKA MOCHA	1060405000	VERDE COSTA/GREEN COAST	1060416000
CROMO/CHROME	1060408000	TERRA SENESE SENESE EARTH	1060417000
ORO CALIFORNIA/GOLD	1060409000		

Il codice contiene 1 testata di chiusura con viti.
The code contains 1 closing warhead with screws.

LAVORAZIONI / PROCESSING



DATI TECNICI TECHNICAL DATA	CODICE CODE
TAGLIO ANGOLARE 90° (PER ANGOLI FORMATI DA DUE PROFILI) TIPO A 90 ° CORNER CUT (FOR CORNERS MADE OF TWO PROFILES) - TYPE A	190A
TAGLIO ANGOLARE 90° (PER ANGOLI FORMATI DA DUE PROFILI) TIPO B 90 ° CORNER CUT (FOR CORNERS MADE OF TWO PROFILES) - TYPE B	190B
TAGLIO ANGOLARE 90° (PER ANGOLI FORMATI DA DUE PROFILI) TIPO C 90 ° CORNER CUT (FOR CORNERS MADE OF TWO PROFILES) - TYPE C	190C
TAGLIO ANGOLARE 90° (PER ANGOLI FORMATI DA DUE PROFILI) TIPO D 90 ° CORNER CUT (FOR CORNERS MADE OF TWO PROFILES) - TYPE D	190D
TAGLIO ANGOLARE 90° (PER ANGOLI FORMATI DA DUE PROFILI) TIPO E 90 ° CORNER CUT (FOR CORNERS MADE OF TWO PROFILES) - TYPE E	190E
TAGLIO ANGOLARE CUSTOM (PER ANGOLI FORMATI DA DUE PROFILI) CUSTOM CORNER CUT (FOR CORNERS MADE OF TWO PROFILES)	190N



ASOLA / SLOT	100A
FORO / HOLE	100F



CABLAGGIO - COLLAUDO - CE AL CENTIMETRO INSTALLATION AND TESTING LED MODULE AT CENTIMETER	1061
--	------



CONNETTORE MASCHIO/FEMMINA MALE/FEMALE CONNECTOR	98CFM
---	-------

CONNETTORE MASCHIO/FEMMINA MONTATO NEL PRODOTTO MALE/FEMALE CONNECTOR FITTED IN THE PRODUCT	98MFM
--	-------



CAVO DI ALIMENTAZIONE 2X0,50 BIANCO 1CM POWER CABLE 2X0,50 WHITE 1CM	98CB001
---	---------

CAVO DI ALIMENTAZIONE 2X0,50 NERO 1CM POWER CABLE 2X0,50 BLACK 1CM	98CN001
---	---------

“ il profilo più piccolo mai progettato ”

MS07 è il sistema di illuminazione più piccolo della famiglia Design Luce. Nonostante le ridotte dimensioni ha una linea unica abbinata ad un diffusore opale recesso che permette di direzionare il fascio luminoso. Può essere installato su qualsiasi superficie mediante appositi sistemi di fissaggio e con la sua sezione quadrata di soli 8,00 mm è particolarmente adatto per illuminare vetrine, bacheche, mensole.

MS07 is the smallest lighting system in the Design Luce family. Despite its small size it has a unique line combined with a recessed opal diffuser that allows to direct the light beam. It can be installed on any surface using special fastening systems and with its square section of only 8.00 mm it is particularly suitable for lighting display cases, showcases, shelves.



INSTALLAZIONE SU SUPERFICI ORIZZONTALI
INSTALLATION ON HORIZONTAL SURFACES

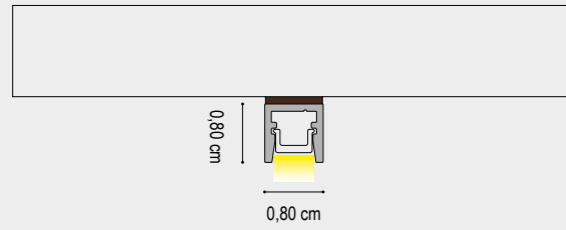

INSTALLAZIONE SU SUPERFICI VERTICALI
INSTALLATION ON VERTICAL SURFACES

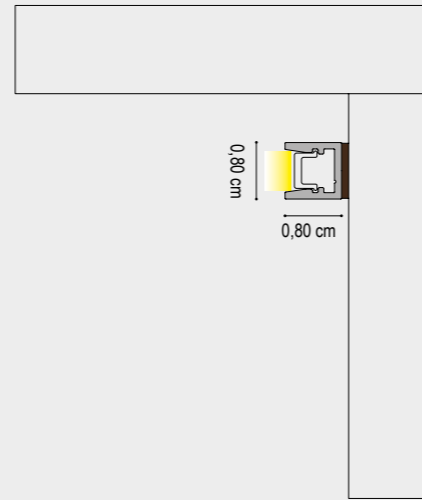

INSTALLAZIONE AD INCASSO
RECESSED INSTALLATION

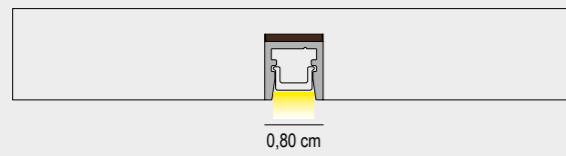

INSTALLAZIONE AD INCASSO
LARGHEZZA TAGLIO

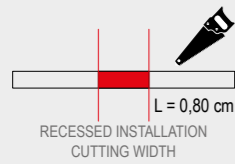

IL PRODOTTO MS07 NON PREVEDE ACCESSORI PER L'INSTALLAZIONE. IL FISSAGGIO DEVE ESSERE REALIZZATO MEDIANTE APPOSITI COLLANTI O NASTRO BIADESIVO. SI RACCOMANDA DI SCEGLIERE IL METODO DI FISSAGGIO ADATTO ALLA SUPERFICIE DI INSTALLAZIONE.

THE MS07 PRODUCT DOES NOT PROVIDE ACCESSORIES FOR INSTALLATION. MOUNTING MUST BE MADE USING SPECIAL ADHESIVES OR DOUBLE-SIDED TAPE. IT IS RECOMMENDED TO CHOOSE THE FASTENING METHOD SUITABLE FOR THE INSTALLATION SURFACE.

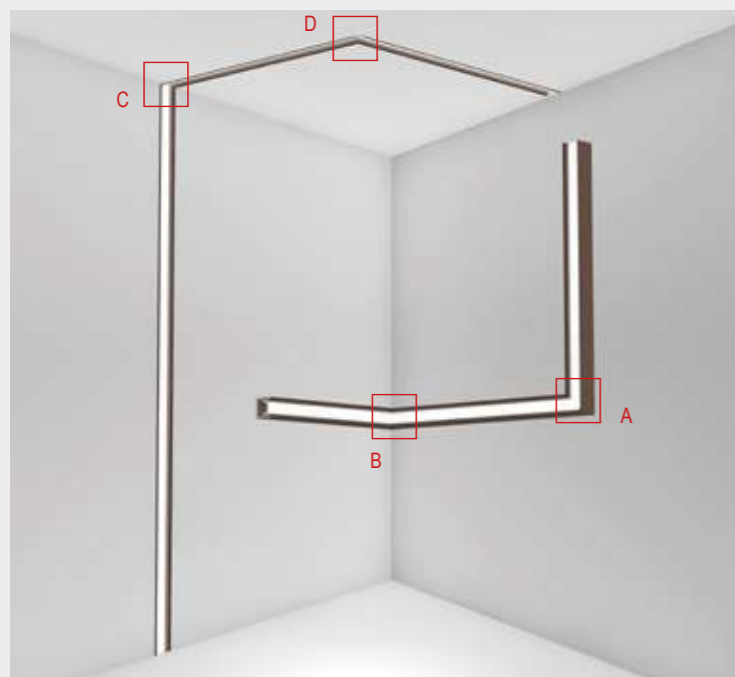

A) TAGLIO ANGOLARE - ANGOLO 90° ORIZZONTALE
A) CORNER CUT - HORIZONTAL 90 ° ANGLE
CODICE ARTICOLO / ITEM NUMBER: 190X

B) TAGLIO ANGOLARE - ANGOLO 90° VERTICALE
B) CORNER CUT - VERTICAL 90 ° ANGLE
CODICE ARTICOLO / ITEM NUMBER: 190Y

C) TAGLIO ANGOLARE - ANGOLO 90° VERTICALE
C) CORNER CUT - VERTICAL 90 ° ANGLE
CODICE ARTICOLO / ITEM NUMBER: 190Y

D) TAGLIO ANGOLARE - ANGOLO 90° ORIZZONTALE
D) CORNER CUT - HORIZONTAL 90 ° ANGLE
CODICE ARTICOLO / ITEM NUMBER: 190X

DATI TECNICI
TECHNICAL DATA

	1 cm	1 cm	1 cm
Nominal LED Flux:	1800 lm/m	1900 lm/m	1990 lm/m
Flux Tot:	1420 lm/m	1520 lm/m	1430 lm/m
Output:	150 lm/W	158 lm/W	166 lm/W
CCT:	2700 K	3000 K	4000 K
CRI:	>90	>90	>90
Power Tot:	12.0W/m	12.0W/m	12.0W/m
Weight:	0.20 Kg/m	0.20 Kg/m	0.20 Kg/m

Alluminio/aluminum
Cover: Opale/opal

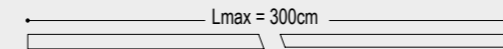

DRIVER NON INCLUSO / NOT INCLUDED

CAVO ALIMENTAZIONE : 50 cm
ALIMENTATION CABLE : 50 cm

FINITURA STRUTTURA
FINISHES

- GRIGIO VESUVIO ANTHRACITE
- ARGILLA CLAY
- ARGENTO OPACO MATT SILVER
- BIANCO INTONACO/WHITE
- NERO CARAVAGGIO BLACK
- MOKA MOCHA
- CROMO/CHROME
- ORO CALIFORNIA/GOLD
- ARAMEN COPPER
- ARGENTO COMETA/SILVER COMET
- OTTONE VENEZIANO BRASS
- TITANIO/TITANIUM
- BRONZO RIACI/RIACI BRONZE
- VERDE COSTA/GREEN COAST
- TERRA SENESE SENESE EARTH

DIFFUSORE
DIFFUSER

OPALE/OPAL

	1 cm - 2700K	1 cm - 3000K	1 cm - 4000K
CODICE CODE	CODICE CODE	CODICE CODE	CODICE CODE
1195400001	1195500001	1195600001	1195600001
1195401001	1195501001	1195601001	1195601001
1195402001	1195502001	1195602001	1195602001
1195403001	1195503001	1195603001	1195603001
1195404001	1195504001	1195604001	1195604001
1195405001	1195505001	1195605001	1195605001
1195408001	1195508001	1195608001	1195608001
1195409001	1195509001	1195609001	1195609001
1195410001	1195510001	1195610001	1195610001
1195412001	1195512001	1195612001	1195612001
1195413001	1195513001	1195613001	1195613001
1195414001	1195514001	1195614001	1195614001
1195415001	1195515001	1195615001	1195615001
1195416001	1195516001	1195616001	1195616001
1195417001	1195517001	1195617001	1195617001

N.B./P.N.: LUNGHEZZA MASSIMA VERSIONE CROMO = 2,00 m / MAXIMUM LENGTH CHROME VERSION = 2.00 m
TESTATE DI CHIUSURA NON INCLUSE / DEAD ENDS NOT INCLUDED

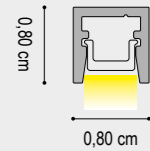
DATI TECNICI
TECHNICAL DATA

	1 cm	1 cm	1 cm
Nominal LED Flux:	1490 lm/m	1560 lm/m	1630 lm/m
Flux Tot:	1178 lm/m	1248 lm/m	1308 lm/m
Output:	124 lm/W	130 lm/W	136 lm/W
CCT:	2700 K	3000 K	4000 K
CRI:	>97 - R9>90	>97 - R9>90	>97 - R9>90
Power Tot:	12.0W/m	12.0W/m	12.0W/m
Weight:	0.20 Kg/m	0.20 Kg/m	0.20 Kg/m

Alluminio/aluminum
Cover: Opale/opal

Lmax = 300cm

DRIVER NON INCLUSO / NOT INCLUDED

CAVO ALIMENTAZIONE : 50 cm
ALIMENTATION CABLE : 50 cmFINITURA STRUTTURA
FINISHES

GRIGIO VESUVIO ANTHRACITE
ARGILLA CLAY
ARGENTO OPACO/MATT SILVER
BIANCO INTONACO/WHITE
NERO CARAVAGGIO/BLACK
MOKA MOCHA
CROMO/CHROME
ORO CALIFORNIA/GOLD
ARAMEN COPPER
ARGENTO COMETA/SILVER COMET
OTTONE VENEZIANO/BRASS
TITANIO/TITANIUM
BRONZO RIACI/RIACI BRONZE
VERDE COSTA/GREEN COAST
TERRA SENESE/SENESE EARTH

DIFFUSORE
DIFFUSER

OPALE/OPAL

1 cm - 2700K

CODICE CODE
1199600001
1199601001
1199602001
1199603001
1199604001
1199605001
1199608001
1199609001
1199610001
1199612001
1199613001
1199614001
1199615001
1199616001
1199617001

1 cm - 3000K

CODICE CODE
1199700001
1199701001
1199702001
1199703001
1199704001
1199705001
1199708001
1199709001
1199710001
1199712001
1199713001
1199714001
1199715001
1199716001
1199717001

1 cm - 4000K

CODICE CODE
1199800001
1199801001
1199802001
1199803001
1199804001
1199805001
1199808001
1199809001
1199810001
1199812001
1199813001
1199814001
1199815001
1199816001
1199817001

N.B./P.N.: LUNGHEZZA MASSIMA VERSIONE CROMO = 2,00 m / MAXIMUM LENGTH CHROME VERSION = 2.00 m
TESTATE DI CHIUSURA NON INCLUSE / DEAD ENDS NOT INCLUDED

TESTATE DI CHIUSURA / DEAD ENDS

FINITURA STRUTTURA
FINISHES

GRIGIO VESUVIO/ANTHRACITE
ARGILLA/ARGIL
ARGENTO OPACO/MATT SILVER
BIANCO INTONACO/WHITE
NERO CARAVAGGIO/BLACK
MOKA/MOCHA
CROMO/CHROME
ORO CALIFORNIA/GOLD

CODICE
CODE

1190400000
1190401000
1190402000
1190403000
1190404000
1190405000
1190408000
1190409000

FINITURA STRUTTURA
FINISHES

ARAMEN/COPPER
ARGENTO COMETA/SILVER COMET
OTTONE VENEZIANO/VENETIAN BRASS
TITANIO/TITANIUM
BRONZO RIACI/RIACI BRONZE
VERDE COSTA/GREEN COAST
TERRA SENESE/SENESE EARTH

CODICE
CODE

1190410000
1190412000
1190413000
1190414000
1190415000
1190416000
1190417000

Il codice contiene 1 testata di chiusura con viti.
The code contains 1 closing warhead with screws.

LAVORAZIONI / PROCESSING

DATI TECNICI
TECHNICAL DATA

TAGLIO 90° ORIZZONTALE (PER ANGOLI FORMATI DA DUE PROFILI)
HORIZONTAL 90 ° CUT (FOR CORNERS MADE OF TWO PROFILES)

190X



TAGLIO 90° VERTICALE (PER ANGOLI FORMATI DA DUE PROFILI)
VERTICAL 90 ° CUT (FOR CORNERS MADE OF TWO PROFILES)

190Y

TAGLIO ANGOLARE CUSTOM (PER ANGOLI FORMATI DA DUE PROFILI)
CUSTOM CORNER CUT (FOR CORNERS MADE OF TWO PROFILES)

190N



FORO / HOLE

100F

CAVO DI ALIMENTAZIONE 2X0,50 BIANCO 1CM
POWER CABLE 2X0,50 WHITE 1CM

98CB001



CAVO DI ALIMENTAZIONE 2X0,50 NERO 1CM
POWER CABLE 2X0,50 BLACK 1CM

98CN001

“illumina vetrine, bacheche, mensole”

MS08 è il secondo profilo più piccolo che la nostra azienda abbia mai progettato. Nasce dalla necessità di ridurre l'abbagliamento luminoso. Sappiamo che una buona luce senza abbagliamento contribuisce ad esaltare le forme e la qualità dei oggetti esposti in vetrine, bacheche e scaffalature. La sua forma innovativa in estruso d'alluminio le cui angolazioni sporgenti, rispetto al diffusore in policarbonato consentono di evidenziare le sue prospettive inoltre i tagli e i cablaggi personalizzati lo rendono estremamente flessibile.

MS08 is the second smallest profile that our company have ever projected. Designed for need to reduce the luminaire pollution. We know that, only without any pollution and with a good light quality, on display objects in showcases, display cases and shelves, maintains forms and qualities. The innovative design in extruded aluminium with its protrude angels and the polycarbonate diff user emphasizes his own prospects. Customized length and diverse assembly solutions offer high flexibility.

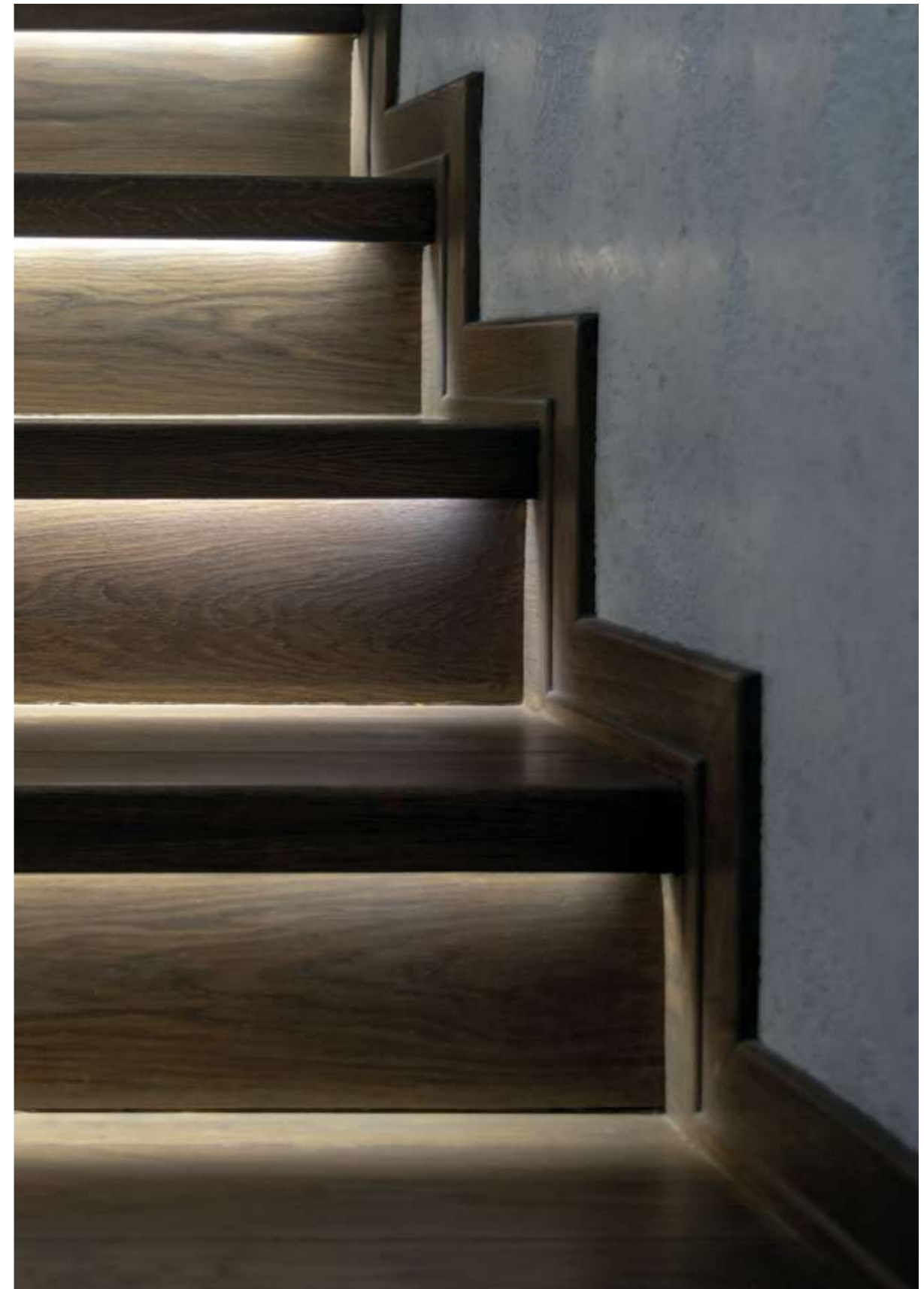
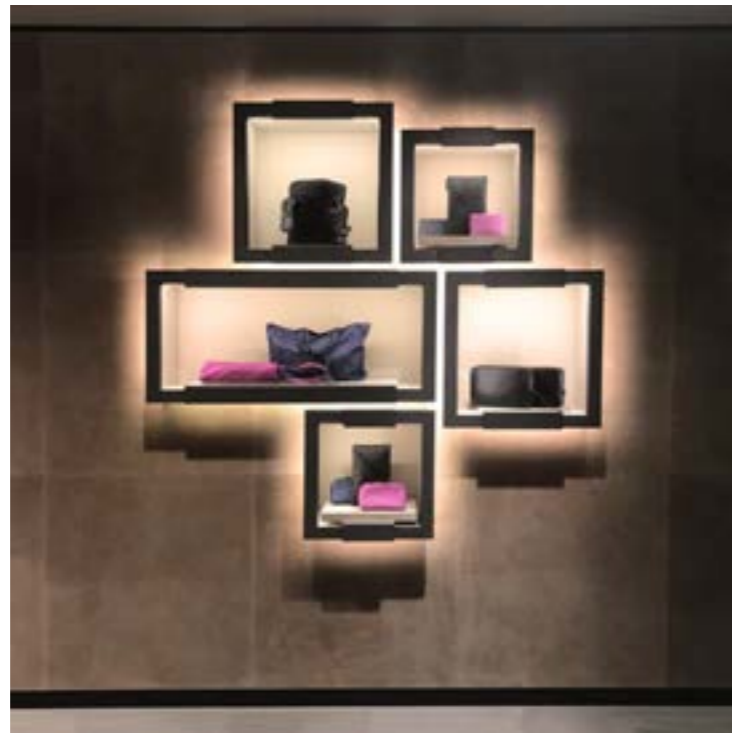

ms08

led integrato

integrated led

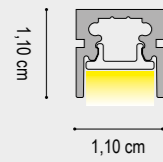

DATI TECNICI
TECHNICAL DATA

	1 cm	1 cm	1 cm
Nominal LED Flux:	1800 lm/m	1900 lm/m	1990 lm/m
Flux Tot:	1420 lm/m	1520 lm/m	1430 lm/m
Output:	150 lm/W	158 lm/W	166 lm/W
CCT:	2700 K	3000 K	4000 K
CRI:	>90	>90	>90
Power Tot:	12.0W/m	12.0W/m	12.0W/m
Weight:	0.20 Kg/m	0.20 Kg/m	0.20 Kg/m

Alluminio/aluminum
Cover: Opale/opal

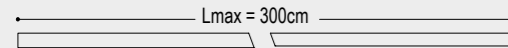

DRIVER NON INCLUSO / NOT INCLUDED

CAVO ALIMENTAZIONE : 50 cm
ALIMENTATION CABLE : 50 cm

FINITURA STRUTTURA
FINISHES

- GRIGIO VESUVIO ANTHRACITE
- ARGILLA CLAY
- ARGENTO OPACO/MATT SILVER
- BIANCO INTONACO/WHITE
- NERO CARAVAGGIO BLACK
- MOKA MOCHA
- CROMO/CHROME
- ORO CALIFORNIA/GOLD
- ARAMEN COPPER
- ARGENTO COMETA/SILVER COMET
- OTTONE VENEZIANO BRASS
- TITANIO/TITANIUM
- BRONZO RIACI/RIACI BRONZE
- VERDE COSTA/GREEN COAST
- TERRA SENESE SENESE EARTH

DIFFUSORE
DIFFUSER

OPALE/OPAL

1 cm - 2700K 1 cm - 3000K 1 cm - 4000K

CODICE CODE	CODICE CODE	CODICE CODE
1085400001	1085500001	1085600001
1085401001	1085501001	1085601001
1085402001	1085502001	1085602001
1085403001	1085503001	1085603001
1085404001	1085504001	1085604001
1085405001	1085505001	1085605001
1085408001	1085508001	1085608001
1085409001	1085509001	1085609001
1085410001	1085510001	1085610001
1085412001	1085512001	1085612001
1085413001	1085513001	1085613001
1085414001	1085514001	1085614001
1085415001	1085515001	1085615001
1085416001	1085516001	1085616001
1085417001	1085517001	1085617001

N.B./P.N.: LUNGHEZZA MASSIMA VERSIONE CROMO = 2,00 m / MAXIMUM LENGTH CHROME VERSION = 2.00 m
TESTATE DI CHIUSURA NON INCLUSE / DEAD ENDS NOT INCLUDED

ms08

led integrato

integrated led

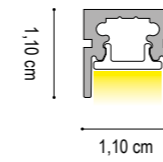

DATI TECNICI
TECHNICAL DATA

	1 cm	1 cm	1 cm
Nominal LED Flux:	1490 lm/m	1560 lm/m	1630 lm/m
Flux Tot:	1178 lm/m	1248 lm/m	1308 lm/m
Output:	124 lm/W	130 lm/W	136 lm/W
CCT:	2700 K	3000 K	4000 K
CRI:	>97 - R9>90	>97 - R9>90	>97 - R9>90
Power Tot:	12.0W/m	12.0W/m	12.0W/m
Weight:	0.20 Kg/m	0.20 Kg/m	0.20 Kg/m

Alluminio/aluminum
Cover: Opale/opal

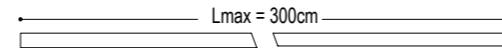

DRIVER NON INCLUSO / NOT INCLUDED

CAVO ALIMENTAZIONE : 50 cm
ALIMENTATION CABLE : 50 cm

FINITURA STRUTTURA
FINISHES

- GRIGIO VESUVIO ANTHRACITE
- ARGILLA CLAY
- ARGENTO OPACO/MATT SILVER
- BIANCO INTONACO/WHITE
- NERO CARAVAGGIO BLACK
- MOKA MOCHA
- CROMO/CHROME
- ORO CALIFORNIA/GOLD
- ARAMEN COPPER
- ARGENTO COMETA/SILVER COMET
- OTTONE VENEZIANO BRASS
- TITANIO/TITANIUM
- BRONZO RIACI/RIACI BRONZE
- VERDE COSTA/GREEN COAST
- TERRA SENESE SENESE EARTH

DIFFUSORE
DIFFUSER

OPALE/OPAL

1 cm - 2700K 1 cm - 3000K 1 cm - 4000K

CODICE CODE	CODICE CODE	CODICE CODE
1089600001	1089700001	1089800001
1089601001	1089701001	1089801001
1089602001	1089702001	1089802001
1089603001	1089703001	1089803001
1089604001	1089704001	1089804001
1089605001	1089705001	1089805001
1089608001	1089708001	1089808001
1089609001	1089709001	1089809001
1089610001	1089710001	1089810001
1089612001	1089712001	1089812001
1089613001	1089713001	1089813001
1089614001	1089714001	1089814001
1089615001	1089715001	1089815001
1089616001	1089716001	1089816001
1089617001	1089717001	1089817001

N.B./P.N.: LUNGHEZZA MASSIMA VERSIONE CROMO = 2,00 m / MAXIMUM LENGTH CHROME VERSION = 2.00 m
TESTATE DI CHIUSURA NON INCLUSE / DEAD ENDS NOT INCLUDED

DATI TECNICI
TECHNICAL DATA

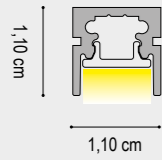

	1 cm	1 cm	1 cm
Nominal LED Flux:	1510 lm/m	1584 lm/m	1650 lm/m
Flux Tot:	1217 lm/m	1267 lm/m	1337 lm/m
Output:	105 lm/W	110 lm/W	110 lm/W
CCT:	2700 K	3000 K	4000 K
CRI:	>95	>95	>95
Power Tot:	14.4W/m	14.4W/m	14.4W/m
Weight:	0.30 Kg/m	0.30 Kg/m	0.30 Kg/m

Alluminio/aluminum
Cover: Opale/opal

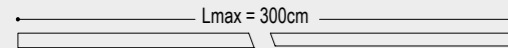

DRIVER NON INCLUSO / NOT INCLUDED

CAVO ALIMENTAZIONE : 50 cm
ALIMENTATION CABLE : 50 cm

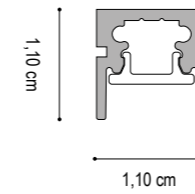

Diffusore in policarbonato
Polycarbonate diffuser

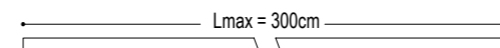

FINITURA STRUTTURA FINISHES	DIFFUSORE DIFFUSER	1 cm - 2700K	1 cm - 3000K	1 cm - 4000K
		CODICE CODE	CODICE CODE	CODICE CODE
GRIGIO VESUVIO ANTHRACITE	OPALE/OPAL	108K100001	108K200001	108K300001
ARGILLA CLAY		108K101001	108K201001	108K301001
ARGENTO OPACO/MATT SILVER		108K102001	108K202001	108K302001
BIANCO INTONACO/WHITE		108K103001	108K203001	108K303001
NERO CARAVAGGIO/BLACK		108K104001	108K204001	108K304001
MOKA MOCHA		108K105001	108K205001	108K305001
CROMO/CHROME		108K108001	108K208001	108K308001
ORO CALIFORNIA/GOLD		108K109001	108K209001	108K309001
ARAMEN COPPER		108K110001	108K210001	108K310001
ARGENTO COMETA/SILVER COMET		108K112001	108K212001	108K312001
OTTONE VENEZIANO/BRASS		108K113001	108K213001	108K313001
TITANIO/TITANIUM		108K114001	108K214001	108K314001
BRONZO RIACI/RIACI BRONZE		108K115001	108K215001	108K315001
VERDE COSTA/GREEN COAST		108K116001	108K216001	108K316001
TERRA SENESE/SENESE EARTH	108K117001	108K217001	108K317001	

N.B./P.N.: LUNGHEZZA MASSIMA VERSIONE CROMO = 2,00 m / MAXIMUM LENGTH CHROME VERSION = 2.00 m
TESTATE DI CHIUSURA NON INCLUSE / DEAD ENDS NOT INCLUDED

FINITURA STRUTTURA FINISHES	DIFFUSORE DIFFUSER	1 cm	200 cm	300 cm
		CODICE CODE	CODICE CODE	CODICE CODE
GRIGIO VESUVIO/ANTHRACITE	OPALE/OPAL	108CP00001	108CP00200	108CP00300
ARGILLA/ARGIL		108CP01001	108CP01200	108CP01300
ARGENTO OPACO/MATT SILVER		108CP02001	108CP02200	108CP02300
BIANCO INTONACO/WHITE		108CP03001	108CP03200	108CP03300
NERO CARAVAGGIO/BLACK		108CP04001	108CP04200	108CP04300
MOKA/MOCHA		108CP05001	108CP05200	108CP05300
ALLUMINIO NATURALE/ALUMINIUM		108CP06001	108CP06200	108CP06300
ORO CALIFORNIA/GOLD		108CP09001	108CP09200	108CP09300
ARAMEN/COPPER		108CP10001	108CP10200	108CP10300
ARGENTO COMETA/SILVER COMET		108CP12001	108CP12200	108CP12300
OTTONE VENEZIANO/BRASS		108CP13001	108CP13200	108CP13300
TITANIO/TITANIUM		108CP14001	108CP14200	108CP14300
BRONZO RIACI/RIACI BRONZE		108CP15001	108CP15200	108CP15300
VERDE COSTA/GREEN COAST		108CP16001	108CP16200	108CP16300
TERRA SENESE/SENESE EARTH		108CP17001	108CP17200	108CP17300
GRIGIO AVIO/GREY AVIO		108CP11001	108CP11200	108CP11300
CROMO/CHROME	108CP08001	108CP08200		

N.B./P.N.: LUNGHEZZA MASSIMA VERSIONE CROMO = 2,00 m / MAXIMUM LENGTH CHROME VERSION = 2.00 m
TESTATE DI CHIUSURA NON INCLUSE / DEAD ENDS NOT INCLUDED

LED compatibili / LED compatibility **NEW**

ULTRA SLIM CRI>90 CRI>95 CRI>97	RGB SLIM	SLIM ONE CHIP
7,0W	14,4W	7,0W
9,6W		9,0W
12W		19,2W
14,4W		



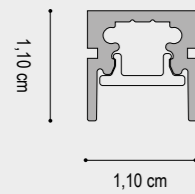

Diffusore in policarbonato
Polycarbonate diffuser

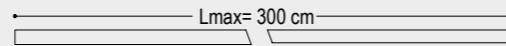

FINITURA STRUTTURA FINISHES	DIFFUSORE DIFFUSER	1 cm	200 cm	300 cm
		CODICE CODE	CODICE CODE	CODICE CODE
GRIGIO VESUVIO/ANTHRACITE	PRISMATIZZATO PRISMATIC	108CR00001	108CR00200	108CR00300
ARGILLA/ARGIL		108CR01001	108CR01200	108CR01300
ARGENTO OPACO/MATT SILVER		108CR02001	108CR02200	108CR02300
BIANCO INTONACO/WHITE		108CR03001	108CR03200	108CR03300
NERO CARAVAGGIO/BLACK		108CR04001	108CR04200	108CR04300
MOKA/MOCHA		108CR05001	108CR05200	108CR05300
ORO CALIFORNIA/GOLD		108CR09001	108CR09200	108CR09300
ARAMEN/COPPER		108CR10001	108CR10200	108CR10300
ARGENTO COMETA/SILVER COMET		108CR12001	108CR12200	108CR12300
OTTONE VENEZIANO/BRASS		108CR13001	108CR13200	108CR13300
TITANIO/TITANIUM		108CR14001	108CR14200	108CR14300
BRONZO RIACI/RIACI BRONZE		108CR15001	108CR15200	108CR15300
VERDE COSTA/GREEN COAST		108CR16001	108CR16200	108CR16300
TERRA SENESE/SENESE EARTH		108CR17001	108CR17200	108CR17300
CROMO/CHROME		108CR08001	108CR08200	108CR17300

TESTATE DI CHIUSURA / DEAD ENDS



FINITURA STRUTTURA FINISHES	CODICE CODE	FINITURA STRUTTURA FINISHES	CODICE CODE
GRIGIO VESUVIO/ANTHRACITE	1080400000	ORO CALIFORNIA/GOLD	1080409000
ARGILLA/ARGIL	1080401000	ARAMEN/COPPER	1080410000
ARGENTO OPACO/MATT SILVER	1080402000	ARGENTO COMETA/SILVER COMET	1080412000
BIANCO INTONACO/WHITE	1080403000	OTTONE VENEZIANO/BRASS	1080413000
NERO CARAVAGGIO/BLACK	1080404000	TITANIO/TITANIUM	1080414000
MOKA/MOCHA	1080405000	BRONZO RIACI/RIACI BRONZE	1080415000
ALLUMINIO NATURALE/ALUMINUM	1080406000	VERDE COSTA/GREEN COAST	1080416000
CROMO/CHROME	1080408000	TERRA SENESE/SENESE EARTH	1080417000

Il codice contiene 1 testata di chiusura con viti.
The code contains 1 closing warhead with screws.

LAVORAZIONI / PROCESSING

DATI TECNICI TECHNICAL DATA	CODICE CODE
TAGLIO 90° ORIZZONTALE (PER ANGOLI FORMATI DA DUE PROFILI) HORIZONTAL 90 ° CUT (FOR CORNERS MADE OF TWO PROFILES)	190X
TAGLIO 90° VERTICALE (PER ANGOLI FORMATI DA DUE PROFILI) VERTICAL 90 ° CUT (FOR CORNERS MADE OF TWO PROFILES)	190Y
TAGLIO ANGOLARE CUSTOM (PER ANGOLI FORMATI DA DUE PROFILI) CUSTOM CORNER CUT (FOR CORNERS MADE OF TWO PROFILES)	190N
FORO / HOLE	100F
CABLAGGIO - COLLAUDO - CE AL CENTIMETRO INSTALLATION AND TESTING LED MODULE AT CENTIMETER	1081
CAVO DI ALIMENTAZIONE 2X0,50 BIANCO 1CM POWER CABLE 2X0,50 WHITE 1CM	98CB001
CAVO DI ALIMENTAZIONE 2X0,50 NERO 1CM POWER CABLE 2X0,50 BLACK 1CM	98CN001
CAVO DI ALIMENTAZIONE 2X0,75 MARRONE 1CM POWER CABLE 2X0,50 BROWN 1CM	98CS001

N.B./P.N.: LUNGHEZZA MASSIMA VERSIONE CROMO = 2,00 m / MAXIMUM LENGTH CHROME VERSION = 2.00 m
TESTATE DI CHIUSURA NON INCLUSE / DEAD ENDS NOT INCLUDED

LED compatibili / LED compatibility **NEW**

ULTRA SLIM CRI>90 CRI>95 CRI>97	RGB SLIM	SLIM ONE CHIP
7,0W 9,6W 12W 14,4W	14,4W	7,0W 9,0W 19,2W

“valorizza gli oggetti e gli ambienti”

MS09 è il più grande della famiglia MS; come gli altri contribuisce a ridurre l'abbagliamento e a valorizzare gli oggetti e gli ambienti. La sua forma innovativa in estruso d'alluminio le cui angolazioni sporgenti, rispetto al diffusore in policarbonato consentono di evidenziare le sue prospettive. I tagli e i cablaggi personalizzati lo rendono estremamente flessibile.

MS09 is the largest of the MS family; like the others, reduce glare and enhance objects and environments. Its innovative shape in extruded aluminum whose protruding angles, compared to the polycarbonate diffuser allow to highlight its perspectives. The custom cuts and wiring make it extremely flexible.



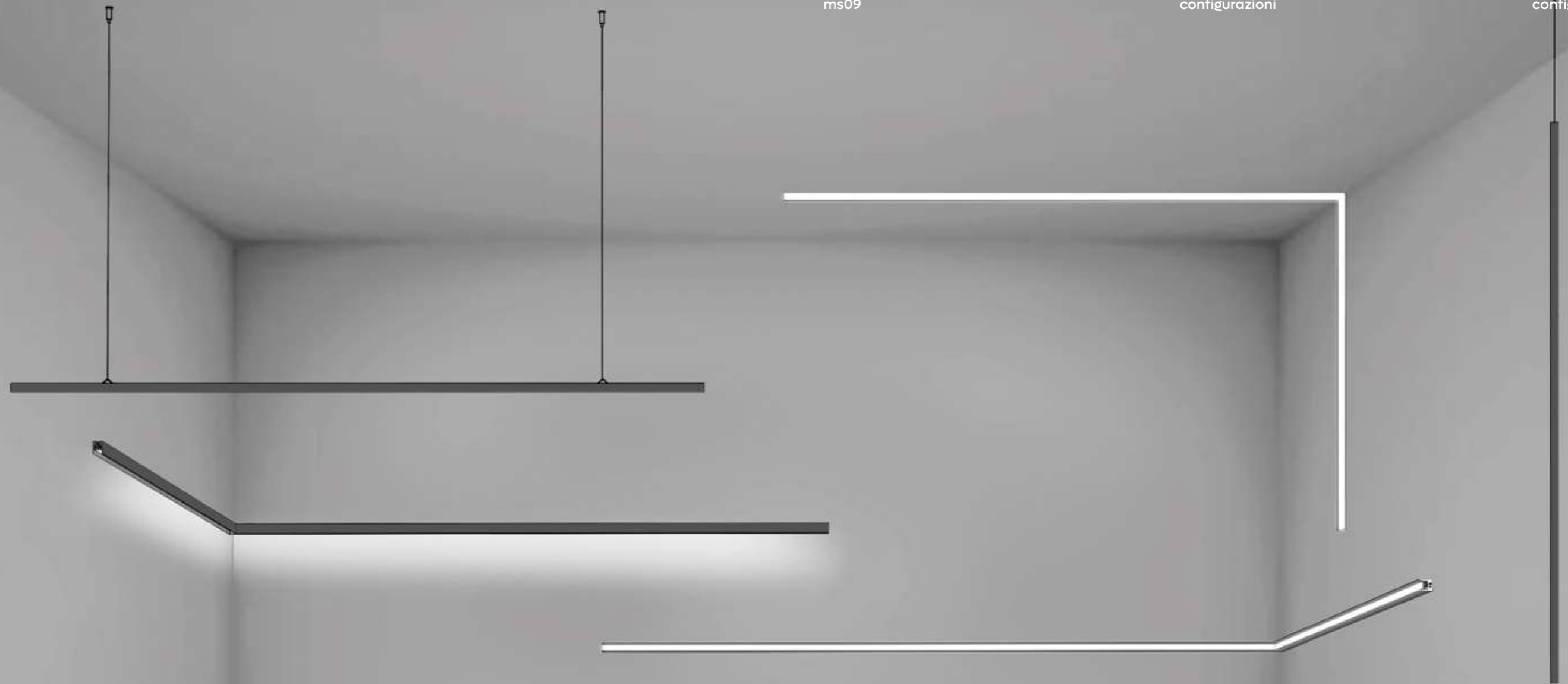

ATTENZIONE! GLI ACCESSORI PER L'INSTALLAZIONE A INCASSO SONO STATI DIMENSIONATI PER UN PANNELLO STANDARD IN CARTONGESSO DI SPESSORE 12,5 mm
 WARNING! THE BUILT-IN INSTALLATION ACCESSORIES HAVE BEEN DIMENSIONED FOR A STANDARD PLASTERBOARD PANEL OF 12.5 mm THICKNESS

INSTALLAZIONE A SOSPENSIONE
 SUSPENSION

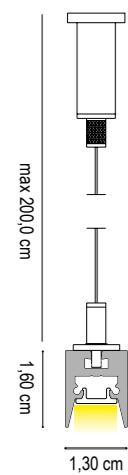

INSTALLAZIONE CON CLIP IN POLICARBONATO SU SUPERFICIE ORIZZONTALE
 INSTALLATION WITH POLYCARBONATE CLIP ON HORIZONTAL SURFACE

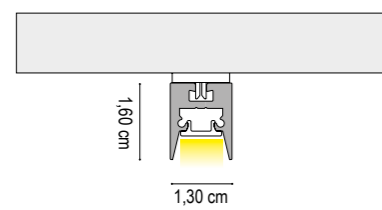

INSTALLAZIONE CON CALAMITA SU SUPERFICIE METALLICA ORIZZONTALE
 INSTALLATION WITH MAGNET ON HORIZONTAL METAL SURFACE

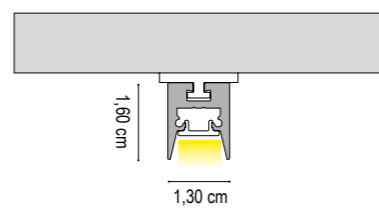

SI RACCOMANDA L'UTILIZZO DI N° 1 STAFFA MAGNETICA OGNI 25,00 cm DI PROFILO. TALE QUANTITÀ PUÒ VARIARE A SECONDA DELLA SUPERFICIE METALLICA DI INSTALLAZIONE.

WE RECOMMEND THE USE OF N° 1 MAGNETIC BRACKET EVERY 25.00 cm OF PROFILE. THIS QUANTITY MAY VARY DEPENDING ON THE METAL INSTALLATION SURFACE.

INSTALLAZIONE CON CLIP IN POLICARBONATO SU SUPERFICIE VERTICALE
 INSTALLATION WITH POLYCARBONATE CLIP ON A VERTICAL SURFACE

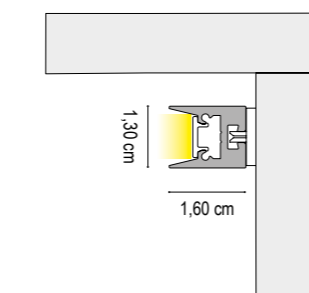

INSTALLAZIONE A PARETE
 WALL INSTALLATION

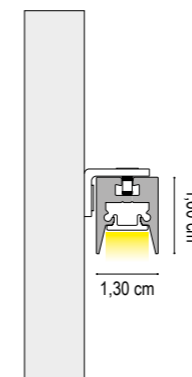

INSTALLAZIONE CON STAFFA PER INCASSO
 INSTALLATION WITH BUILT-IN BRACKET

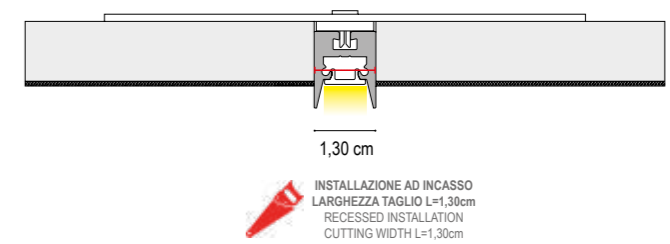

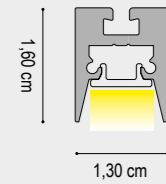

DATI TECNICI
TECHNICAL DATA

	1 cm	1 cm	1 cm
Nominal LED Flux:	1800 lm/m	1900 lm/m	1990 lm/m
Flux Tot:	1420 lm/m	1520 lm/m	1430 lm/m
Output:	150 lm/W	158 lm/W	166 lm/W
CCT:	2700 K	3000 K	4000 K
CRI:	>90	>90	>90
Power Tot:	12.0W/m	12.0W/m	12.0W/m
Weight:	0.20 Kg/m	0.20 Kg/m	0.20 Kg/m

Alluminio/aluminum
Cover: Opale/opal

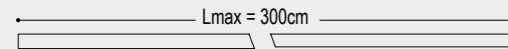

DRIVER NON INCLUSO / NOT INCLUDED

CAVO ALIMENTAZIONE : 50 cm
ALIMENTATION CABLE : 50 cm

FINITURA STRUTTURA
FINISHES

- GRIGIO VESUVIO ANTHRACITE
- ARGILLA CLAY
- ARGENTO OPACO MATT SILVER
- BIANCO INTONACO WHITE
- NERO CARAVAGGIO BLACK
- MOKA MOCHA
- CROMO CHROME
- ORO CALIFORNIA GOLD
- ARAMEN COPPER
- ARGENTO COMETA SILVER COMET
- OTTONE VENEZIANO BRASS
- TITANIO TITANIUM
- BRONZO RIACI RIACI BRONZE
- VERDE COSTA GREEN COAST
- TERRA SENESE SENESE EARTH

DIFFUSORE
DIFFUSER

OPALE/OPAL

1 cm - 2700K 1 cm - 3000K 1 cm - 4000K

CODICE CODE	CODICE CODE	CODICE CODE
1095400001	1095500001	1095600001
1095401001	1095501001	1095601001
1095402001	1095502001	1095602001
1095403001	1095503001	1095603001
1095404001	1095504001	1095604001
1095405001	1095505001	1095605001
1095408001	1095508001	1095608001
1095409001	1095509001	1095609001
1095410001	1095510001	1095610001
1095412001	1095512001	1095612001
1095413001	1095513001	1095613001
1095414001	1095514001	1095614001
1095415001	1095515001	1095615001
1095416001	1095516001	1095616001
1095417001	1095517001	1095617001

N.B./P.N.: LUNGHEZZA MASSIMA VERSIONE CROMO = 2,00 m / MAXIMUM LENGTH CHROME VERSION = 2.00 m
TESTATE DI CHIUSURA NON INCLUSE / DEAD ENDS NOT INCLUDED

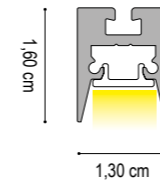

DATI TECNICI
TECHNICAL DATA

	1 cm	1 cm	1 cm
Nominal LED Flux:	1490 lm/m	1560 lm/m	1630 lm/m
Flux Tot:	1178 lm/m	1248 lm/m	1308 lm/m
Output:	124 lm/W	130 lm/W	136 lm/W
CCT:	2700 K	3000 K	4000 K
CRI:	>97 - R9>90	>97 - R9>90	>97 - R9>90
Power Tot:	12.0W/m	12.0W/m	12.0W/m
Weight:	0.20 Kg/m	0.20 Kg/m	0.20 Kg/m

Alluminio/aluminum
Cover: Opale/opal

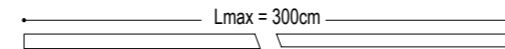

DRIVER NON INCLUSO / NOT INCLUDED

CAVO ALIMENTAZIONE : 50 cm
ALIMENTATION CABLE : 50 cm

FINITURA STRUTTURA
FINISHES

- GRIGIO VESUVIO ANTHRACITE
- ARGILLA CLAY
- ARGENTO OPACO MATT SILVER
- BIANCO INTONACO WHITE
- NERO CARAVAGGIO BLACK
- MOKA MOCHA
- CROMO CHROME
- ORO CALIFORNIA GOLD
- ARAMEN COPPER
- ARGENTO COMETA SILVER COMET
- GRIGIO AVIO GREY AVIO
- OTTONE VENEZIANO BRASS
- TITANIO TITANIUM
- BRONZO RIACI RIACI BRONZE
- VERDE COSTA GREEN COAST
- TERRA SENESE SENESE EARTH

DIFFUSORE
DIFFUSER

OPALE/OPAL

1 cm - 2700K 1 cm - 3000K 1 cm - 4000K

CODICE CODE	CODICE CODE	CODICE CODE
1099600001	1099700001	1099800001
1099601001	1099701001	1099801001
1099602001	1099702001	1099802001
1099603001	1099703001	1099803001
1099604001	1099704001	1099804001
1099605001	1099705001	1099805001
1099608001	1099708001	1099808001
1099609001	1099709001	1099809001
1099610001	1099710001	1099810001
1099612001	1099712001	1099812001
1099611001	1099711001	1099811001
1099613001	1099713001	1099813001
1099614001	1099714001	1099814001
1099615001	1099715001	1099815001
1099616001	1099716001	1099816001
1099617001	1099717001	1099817001

N.B./P.N.: LUNGHEZZA MASSIMA VERSIONE CROMO = 2,00 m / MAXIMUM LENGTH CHROME VERSION = 2.00 m
TESTATE DI CHIUSURA NON INCLUSE / DEAD ENDS NOT INCLUDED

ms09

led integrato

integrated led

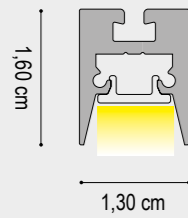

DATI TECNICI
TECHNICAL DATA

	1 cm	1 cm	1 cm
Nominal LED Flux:	1510 lm/m	1584 lm/m	1650 lm/m
Flux Tot:	1217 lm/m	1267 lm/m	1337 lm/m
Output:	105 lm/W	110 lm/W	138 lm/W
CCT:	2700 K	3000 K	4000 K
CRI:	>95	>95	>95
Power Tot:	14.4W/m	14.4W/m	14.4W/m
Weight:	0.30 Kg/m	0.30 Kg/m	0.30 Kg/m

Alluminio/aluminum
Cover: Opale/opal

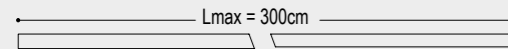

DRIVER NON INCLUSO / NOT INCLUDED

CAVO ALIMENTAZIONE : 50 cm
ALIMENTATION CABLE : 50 cm

FINITURA STRUTTURA
FINISHES

- GRIGIO VESUVIO ANTHRACITE
- ARGILLA CLAY
- ARGENTO OPACO/MATT SILVER
- BIANCO INTONACO/WHITE
- NERO CARAVAGGIO/BLACK
- MOKA MOCHA
- CROMO/CHROME
- ORO CALIFORNIA/GOLD
- ARAMEN COPPER
- ARGENTO COMETA/SILVER COMET
- OTTONE VENEZIANO/BRASS
- TITANIO/TITANIUM
- BRONZO RIACI/RIACI BRONZE
- VERDE COSTA/GREEN COAST
- TERRA SENESE/SENESE EARTH

DIFFUSORE
DIFFUSER

OPALE/OPAL

1 cm - 2700K 1 cm - 3000K 1 cm - 4000K

CODICE CODE	CODICE CODE	CODICE CODE
109K100001	109K200001	109K300001
109K101001	109K201001	109K301001
109K102001	109K202001	109K302001
109K103001	109K203001	109K303001
109K104001	109K204001	109K304001
109K105001	109K205001	109K305001
109K108001	109K208001	109K308001
109K109001	109K209001	109K309001
109K110001	109K210001	109K310001
109K111001	109K211001	109K311001
109K113001	109K213001	109K313001
109K114001	109K214001	109K314001
109K115001	109K215001	109K315001
109K116001	109K216001	109K316001
109K117001	109K217001	109K317001

N.B./P.N.: LUNGHEZZA MASSIMA VERSIONE CROMO = 2,00 m / MAXIMUM LENGTH CHROME VERSION = 2.00 m
TESTATE DI CHIUSURA NON INCLUSE / DEAD ENDS NOT INCLUDED

ms09

led non integrato

not integrated led

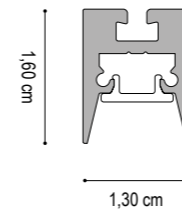

Diffusore in policarbonato
Polycarbonate diffuser

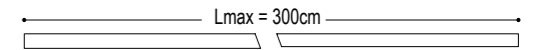

FINITURA STRUTTURA
FINISHES

- GRIGIO VESUVIO/ANTHRACITE
- ARGILLA/ARGIL
- ARGENTO OPACO/MATT SILVER
- BIANCO INTONACO/WHITE
- NERO CARAVAGGIO/BLACK
- MOKA/MOCHA
- ORO CALIFORNIA/GOLD
- ARAMEN/COPPER
- ARGENTO COMETA/SILVER COMET
- OTTONE VENEZIANO/BRASS
- TITANIO/TITANIUM
- BRONZO RIACI/RIACI BRONZE
- VERDE COSTA/GREEN COAST
- TERRA SENESE/SENESE EARTH
- CROMO/CHROME

DIFFUSORE
DIFFUSER

OPALE/OPAL

1 cm 200 cm 300 cm

CODICE CODE	CODICE CODE	CODICE CODE
109CP00001	109CP00200	109CP00300
109CP01001	109CP01200	109CP01300
109CP02001	109CP02200	109CP02300
109CP03001	109CP03200	109CP03300
109CP04001	109CP04200	109CP04300
109CP05001	109CP05200	109CP05300
109CP09001	109CP09200	109CP09300
109CP10001	109CP10200	109CP10300
109CP12001	109CP12200	109CP12300
109CP13001	109CP13200	109CP13300
109CP14001	109CP14200	109CP14300
109CP15001	109CP15200	109CP15300
109CP16001	109CP16200	109CP16300
109CP17001	109CP17200	109CP17300
109CP08001	109CP08200	

N.B./P.N.: LUNGHEZZA MASSIMA VERSIONE CROMO = 2,00 m / MAXIMUM LENGTH CHROME VERSION = 2.00 m
TESTATE DI CHIUSURA NON INCLUSE / DEAD ENDS NOT INCLUDED

LED compatibili / LED compatibility NEW

ULTRA SLIM CRI>90 CRI>95 CRI>97	RGB SLIM	SLIM ONE CHIP
7,0W	14,4W	7,0W
9,6W		9,0W
12W		19,2W
14,4W		



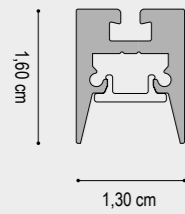

Diffusore in policarbonato
Polycarbonate diffuser

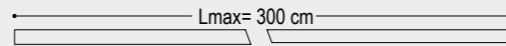

FINITURA STRUTTURA FINISHES	DIFFUSORE DIFFUSER	1 cm	200 cm	300 cm
		CODICE CODE	CODICE CODE	CODICE CODE
GRIGIO VESUVIO/ANTHRACITE	PRISMATIZZATO PRISMATIC	109CR00001	109CR00200	109CR00300
ARGILLA/ARGIL		109CR01001	109CR01200	109CR01300
ARGENTO OPACO/MATT SILVER		109CR02001	109CR02200	109CR02300
BIANCO INTONACO/WHITE		109CR03001	109CR03200	109CR03300
NERO CARAVAGGIO/BLACK		109CR04001	109CR04200	109CR04300
MOKA/MOCHA		109CR05001	109CR05200	109CR05300
ORO CALIFORNIA/GOLD		109CR09001	109CR09200	109CR09300
ARAMEN/COPPER		109CR10001	109CR10200	109CR10300
ARGENTO COMETA/SILVER COMET		109CR12001	109CR12200	109CR12300
OTTONE VENEZIANO/BRASS		109CR13001	109CR13200	109CR13300
TITANIO/TITANIUM		109CR14001	109CR14200	109CR14300
BRONZO RIACI/RIACI BRONZE		109CR15001	109CR15200	109CR15300
VERDE COSTA/GREEN COAST		109CR16001	109CR16200	109CR16300
TERRA SENESE/SENESE EARTH		109CR17001	109CR17200	109CR17300
CROMO/CHROME		109CR08001	109CR08200	109CR08300

N.B./P.N.: LUNGHEZZA MASSIMA VERSIONE CROMO = 2,00 m / MAXIMUM LENGTH CHROME VERSION = 2,00 m
TESTATE DI CHIUSURA NON INCLUSE / DEAD ENDS NOT INCLUDED

LED compatibili / LED compatibility **NEW**

ULTRA SLIM CRI>90 CRI>95 CRI>97	RGB SLIM	SLIM ONE CHIP
7,0W 9,6W 12W 14,4W	14,4W	7,0W 9,0W 19,2W

TESTATE DI CHIUSURA / DEAD ENDS



FINITURA STRUTTURA FINISHES	CODICE CODE	FINITURA STRUTTURA FINISHES	CODICE CODE
GRIGIO VESUVIO/ANTHRACITE	1090400000	ARAMEN/COPPER	1090410000
ARGILLA/ARGIL	1090401000	ARGENTO COMETA/SILVER COMET	1090412000
ARGENTO OPACO/MATT SILVER	1090402000	OTTONE VENEZIANO/BRASS	1090413000
BIANCO INTONACO/WHITE	1090403000	TITANIO/TITANIUM	1090414000
NERO CARAVAGGIO/BLACK	1090404000	BRONZO RIACI/RIACI BRONZE	1090415000
MOKA/MOCHA	1090405000	VERDE COSTA/GREEN COAST	1090416000
CROMO/CHROME	1090408000	TERRA SENESE/SENESE EARTH	1090417000
ORO CALIFORNIA/GOLD	1090409000		

Il codice contiene 1 testata di chiusura con viti.
The code contains 1 closing warhead with screws.

STAFFA DI FISSAGGIO A DOPPIO ATTACCO / DOUBLE MOUNTING CLIP CALAMITA / MAGNET



FINITURA FINISHES	CODICE CODE
SUPERFICI PIANE 2mm EVEN SURFACE 2mm	1020500005
SUPERFICI IRREGOLARI 3,9mm UNEVEN SURFACE 3,9mm	1020500006

Accessorio per fissaggio a plafone/superficie. Quantità raccomandata: 1 pz ogni 50 cm di modello.

Ceiling/surface mounting accessory. Recommended quantity 1 pc every 50 cm of model.



CODICE CODE	PORTATA RANGE
1020500010	1 Kg
1020500210	2 Kg

Quantità raccomandata: 1 pz ogni 25 cm di modello.

Recommended quantity: 1 pc every 25 cm of model.

GIUNTI / JOINTS

GIUNTO LINEA CONTINUA / STRAIGHT JOINT

Accessorio per giunzioni meccaniche lineari
Accessory for linear mechanical joints

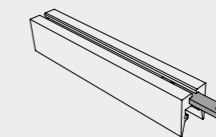

FINITURA FINISHES	CODICE CODE
ALLUMINIO NATURALE/ALUMINUM	1010500006

GIUNTO 90° ORIZZONTALE / HORIZONTAL JOINT 90°

Accessorio per giunzioni meccaniche con angolo 90°
Accessory for linear mechanical joints with 90° angle

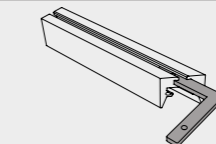

FINITURA FINISHES	CODICE CODE
ALLUMINIO NATURALE/ALUMINUM	1010500005

GIUNTO 90° VERTICALE / VERTICAL JOINT 90°

Accessorio per giunzioni meccaniche con angolo 90°
Accessory for linear mechanical joints with 90° angle

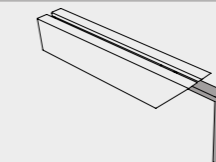

FINITURA FINISHES	CODICE CODE
ALLUMINIO NATURALE/ALUMINUM	1010500007

Il codice contiene i grani per il fissaggio del giunto.
The code contains the grains to fix the joint.

STAFFA INCASSO PER CARTONGESSO / SEMI-BASED BRACKET FOR PLASTERBOARD

DATI TECNICI
TECHNICAL DATA

Accessorio che consente l'incasso del modello.
Accessory that allows the collection of the model.

Nel codice sono comprese le viti per il fissaggio del modello alla staffa. The code includes screws for fixing their model to the bracket.

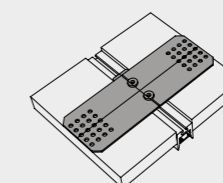

FINITURA STRUTTURA FINISHES	CODICE CODE
ALLUMINIO NATURALE/ALUMINUM	1090500001

KIT DI SOSPENSIONE / SUSPENSION KIT

DATI TECNICI
TECHNICAL DATAARTICOLI INCLUSI NEL CODICE
ARTICLES INCLUDED IN THE CODE

Cavo in acciaio 2,00m con puntalino
2.00m steel cable with tip
Boccola cromata con regolazione millimetrica
Chrome bush with millimeter adjustment
Archetto in alluminio per sospensione
Aluminum arch for suspension

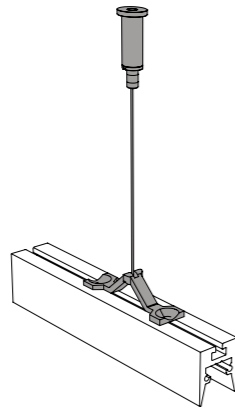
FINITURA STRUTTURA
FINISHES

FINITURA STRUTTURA FINISHES	CODICE CODE
GRIGIO VESUVIO/ANTHRACITE	1040500004
ARGILLA/ARGIL	1040501004
ARGENTO OPACO/MATT SILVER	1040502004
BIANCO INTONACO/WHITE	1040503004
NERO CARAVAGGIO/BLACK	1040504004
MOKA/MOCHA	1040505004
CROMO/CHROME	1040508004
ORO CALIFORNIA/GOLD	1040509004
ARAMEN/COPPER	1040510004
ARGENTO COMETA/SILVER COMET	1030712004
OTTONE VENEZIANO/BRASS	1030713004
TITANIO/TITANIUM	1090714004
BRONZO RIACI/RIACI BRONZE	1090715004
VERDE COSTA/GREEN COAST	1090716004
TERRA SENESE/SENESE EARTH	1040517004

STAFFA DI FISSAGGIO A PARETE / WALL MOUNTING CLIP

DATI TECNICI
TECHNICAL DATA

MATERIALE: Alluminio naturale
MATERIAL: Natural aluminum

Il codice comprende n°2 staffe con asole.
The code includes n°2 wall brackets with holes.

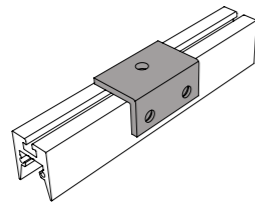
FINITURA STRUTTURA
FINISHES

FINITURA STRUTTURA FINISHES	CODICE CODE
GRIGIO VESUVIO/ANTHRACITE	1010500003
ARGILLA/ARGIL	1010501003
ARGENTO OPACO/MATT SILVER	1010502003
BIANCO INTONACO/WHITE	1010503003
NERO CARAVAGGIO/BLACK	1010504003
MOKA/MOCHA	1010505003
ORO CALIFORNIA/GOLD	1010509003
ARAMEN/COPPER	1010510003
ARGENTO COMETA/SILVER COMET	1030712003
OTTONE VENEZIANO/BRASS	1030713003
TITANIO/TITANIUM	1030714003
BRONZO RIACI/RIACI BRONZE	1090715003
VERDE COSTA/GREEN COAST	1090716003
TERRA SENESE/SENESE EARTH	1010517003

LAVORAZIONI / PROCESSING

DATI TECNICI
TECHNICAL DATA

TAGLIO 90° ORIZZONTALE (PER ANGOLI FORMATI DA DUE PROFILI)
HORIZONTAL 90 ° CUT (FOR CORNERS MADE OF TWO PROFILES)

190X



TAGLIO 90° VERTICALE (PER ANGOLI FORMATI DA DUE PROFILI)
VERTICAL 90 ° CUT (FOR CORNERS MADE OF TWO PROFILES)

190Y

TAGLIO ANGOLARE CUSTOM (PER ANGOLI FORMATI DA DUE PROFILI)
CUSTOM CORNER CUT (FOR CORNERS MADE OF TWO PROFILES)

190N



FORO / HOLE

100F



CABLAGGIO - COLLAUDO - CE AL CENTIMETRO
INSTALLATION AND TESTING LED MODULE AT CENTIMETER

109I

CAVO DI ALIMENTAZIONE 2X0,50 BIANCO 1CM
POWER CABLE 2X0,50 WHITE 1CM

98CB001



CAVO DI ALIMENTAZIONE 2X0,50 NERO 1CM
POWER CABLE 2X0,50 BLACK 1CM

98CN001

CAVO DI ALIMENTAZIONE 2X0,75 MARRONE 1CM
POWER CABLE 2X0,75 BROWN 1CM

98CS001



ut01
ut02

ut01
ut02

designer

luigi cerbone

“linee pulite ed essenziali”

Non sempre piccolo è sinonimo di inefficienza; nella nostra serie Ulisse è racchiusa la massima espressione tecnologica dell'alluminio finalizzata alla dissipazione termica. Ulisse è stato ingegnerizzato per garantire una gestione nella sostituzione del led molto rapida e poco invasiva. Esso assicura una luce morbida e diffusa grazie alle cover appositamente studiate.

Small is not always synonym for inefficiency; our Ulisse series contains the maximum technological expression of aluminum aimed at heat dissipation. Ulisse has been engineered to ensure very rapid and minimally invasive management of LED replacement. It ensures a soft and diffused light thanks to the specially designed covers.



Trimless

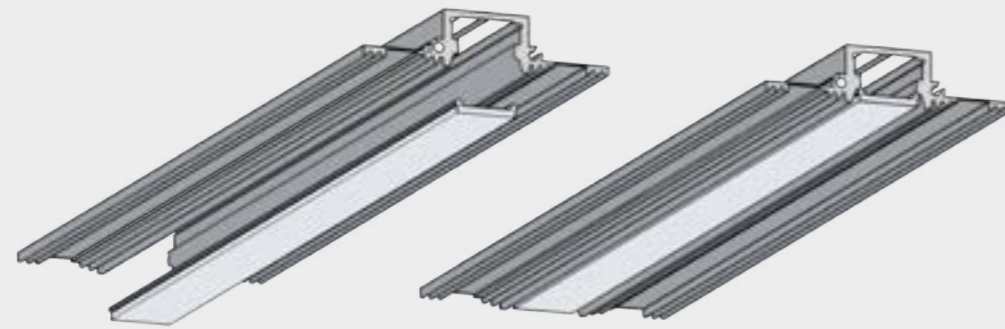

FINITURA STRUTTURA FINISHES	200 cm		300 cm	
	CODICE CODE		CODICE CODE	
BIANCO INTONACO/WHITE	101TP03200		101TP03300	
ALLUMINIO NATURALE/ALUMINUM	101TP06200		101TP06300	

Ulisse sistema innovativo a montaggio rapido

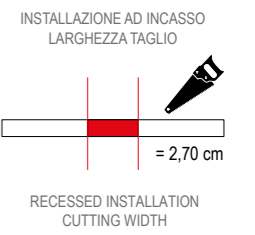
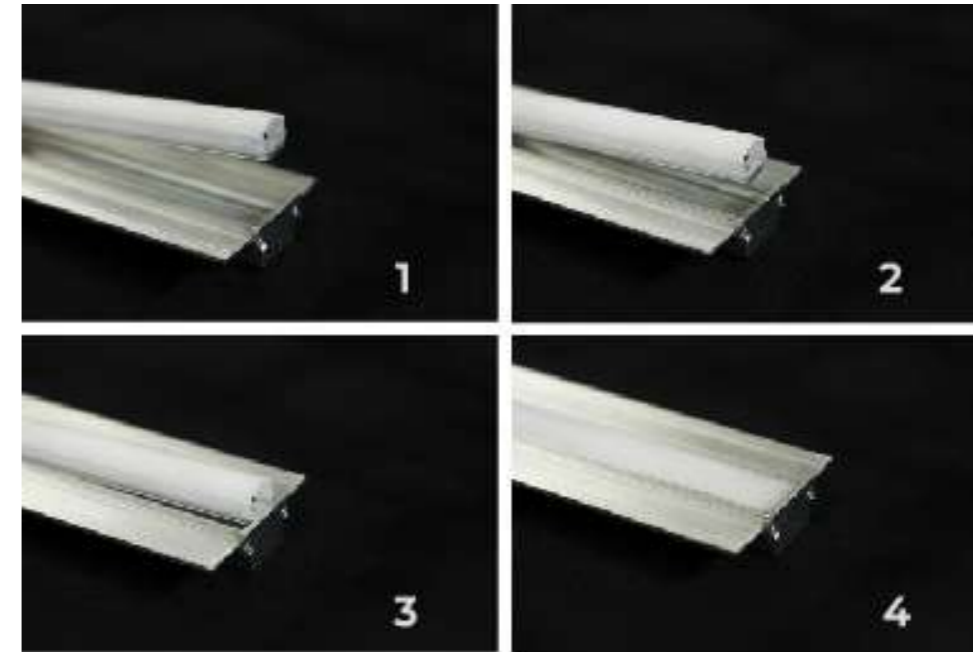

FINITURA STRUTTURA FINISHES	1 cm		200 cm		300 cm	
	CODICE CODE		CODICE CODE		CODICE CODE	
BIANCO INTONACO/WHITE	101T303001		101T303200		101T303300	
ALLUMINIO NATURALE/ALUMINUM	101T306001		101T306200		101T306300	

ut01

led integrato

integrated led

COVER POSA IN OPERA INCLUSA
(COVER MONOUSO PER PROTEGGERE IL PROFILO DURANTE LE FASI DI INSTALLAZIONE)

COVER INSTALLED IS INCLUDED
(DISPOSABLE COVER TO PROTECT THE PROFILE DURING THE INSTALLATION PHASES)

TESTATE NON INCLUSE
DEAD ENDS NOT INCLUDED

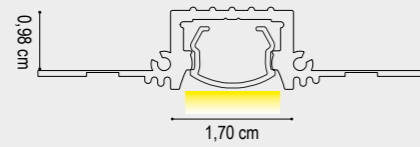

DATI TECNICI
TECHNICAL DATA



	1 cm
LED Flux Tot:	2200 lm/m
Flux Tot:	1680 lm/m
Output:	110 lm/W
CCT:	3000 K
CRI:	>90
Power Tot:	20.0 W/m
Weight:	0.90 Kg/m

Alluminio/aluminum
Cover: Opale/opal

FINITURA STRUTTURA FINISHES	DIFFUSORE DIFFUSER	1 cm - 2700K	1 cm - 3000K	1 cm - 4000K
		CODICE CODE	CODICE CODE	CODICE CODE
BIANCO INTONACO/WHITE	OPALE/OPAL	114603T001	114703T001	114803T001
ALLUMINIO NATURALE/ALUMINUM		114606T001	114706T001	114806T001

PROFILO UT01 PROVISTO DI COVER PER LA STUCCATURA

COVER POSA IN OPERA INCLUSA
(COVER MONOUSO PER PROTEGGERE IL PROFILO DURANTE LE FASI DI INSTALLAZIONE)

COVER INSTALLED IS INCLUDED
(DISPOSABLE COVER TO PROTECT THE PROFILE DURING THE INSTALLATION PHASES)

TESTATE NON INCLUSE
DEAD ENDS NOT INCLUDED

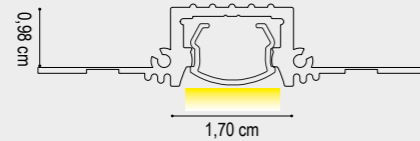

DATI TECNICI
TECHNICAL DATA



	1 cm
LED Flux Tot:	1584 lm/m
Flux Tot:	1267 lm/m
Output:	110 lm/W
CCT:	3000 K
CRI:	>95
Power Tot:	14.4W/m
Weight:	0.40 Kg/m

Alluminio/aluminum
Cover: Opale/opal

FINITURA STRUTTURA FINISHES	DIFFUSORE DIFFUSER	1 cm - 2700K	1 cm - 3000K	1 cm - 4000K
		CODICE CODE	CODICE CODE	CODICE CODE
BIANCO INTONACO/WHITE	OPALE/OPAL	10TG103001	11G203T001	11G303T001
ALLUMINIO NATURALE/ALUMINUM		11G106T001	11G206T001	11G306T001

TESTATE DI CHIUSURA / DEAD ENDS

	FINITURA STRUTTURA FINISHES	CODICE CODE
	BIANCO INTONACO/WHITE	10104T03
	ALLUMINIO NATURALE/ALUMINUM	10104T06

Il codice contiene 1 testata di chiusura con viti.
The code contains 1 closing warhead with screws.

LAVORAZIONI / PROCESSING

DATI TECNICI
TECHNICAL DATA

CODICE
CODE



TAGLIO 90° ORIZZONTALE (PER ANGOLI FORMATI DA DUE PROFILI)
HORIZONTAL 90 ° CUT (FOR CORNERS MADE OF TWO PROFILES)

190X

TAGLIO 90° VERTICALE (PER ANGOLI FORMATI DA DUE PROFILI)
VERTICAL 90 ° CUT (FOR CORNERS MADE OF TWO PROFILES)

190Y

TAGLIO ANGOLARE CUSTOM (PER ANGOLI FORMATI DA DUE PROFILI)
CUSTOM CORNER CUT (FOR CORNERS MADE OF TWO PROFILES)

190N

ASOLA / SLOT

100A

ASOLA CUSTOM / SLOT CUSTOM

100N

FORO / HOLE

100F

CABLAGGIO - COLLAUDO - CE AL CENTIMETRO
INSTALLATION AND TESTING LED MODULE AT CENTIMETER

1011

CONNETTORE MASCHIO/FEMMINA
MALE/FEMALE CONNECTOR

98CFM

CONNETTORE MASCHIO/FEMMINA MONTATO NEL PRODOTTO
MALE/FEMALE CONNECTOR FITTED IN THE PRODUCT

98MFM

CAVO DI ALIMENTAZIONE 2X0,50 BIANCO 1CM
POWER CABLE 2X0,50 WHITE 1CM

98CB001

CAVO DI ALIMENTAZIONE 2X0,50 NERO 1CM
POWER CABLE 2X0,50 BLACK 1CM

98CN001

CAVO DI ALIMENTAZIONE 2X0,75 MARRONE 1CM
POWER CABLE 2X0,75 BROWN 1CM

98CS001

ut02

led integrato

integrated led

COVER POSA IN OPERA INCLUSA
(COVER MONOUSO PER PROTEGGERE IL PROFILO DURANTE LE FASI DI INSTALLAZIONE)

COVER INSTALLED IS INCLUDED
(DISPOSABLE COVER TO PROTECT THE PROFILE DURING THE INSTALLATION PHASES)

TESTATE NON INCLUSE
DEAD ENDS NOT INCLUDED

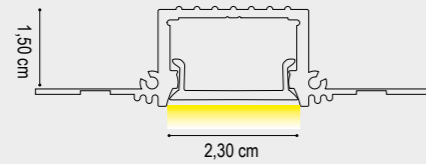

DATI TECNICI
TECHNICAL DATA

D

	1 cm
LED Flux Tot:	2200 lm/m
Flux Tot:	1680 lm/m
Output:	110 lm/W
CCT:	3000 K
CRI:	>90
Power Tot:	20.0 W/m
Weight:	0.90 Kg/m

Alluminio/aluminum
Cover: Opale/opal

FINITURA STRUTTURA FINISHES	DIFFUSORE DIFFUSER	1 cm - 2700K	1 cm - 3000K	1 cm - 4000K
		CODICE CODE	CODICE CODE	CODICE CODE
BIANCO INTONACO/WHITE	OPALE/OPAL	132503T001	132603T001	132703T001
ALLUMINIO NATURALE/ALUMINUM		132506T001	132606T001	132706T001

COVER POSA IN OPERA INCLUSA
(COVER MONOUSO PER PROTEGGERE IL PROFILO DURANTE LE FASI DI INSTALLAZIONE)

COVER INSTALLED IS INCLUDED
(DISPOSABLE COVER TO PROTECT THE PROFILE DURING THE INSTALLATION PHASES)

TESTATE NON INCLUSE
DEAD ENDS NOT INCLUDED

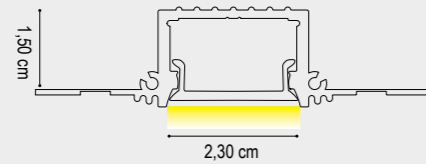

DATI TECNICI
TECHNICAL DATA

F

	1 cm
LED Flux Tot:	1584 lm/m
Flux Tot:	1267 lm/m
Output:	110 lm/W
CCT:	3000 K
CRI:	>95
Power Tot:	14.4W/m
Weight:	0.40 Kg/m

Alluminio/aluminum
Cover: Opale/opal

FINITURA STRUTTURA FINISHES	DIFFUSORE DIFFUSER	1 cm -2700K	1 cm - 3000K	1 cm - 4000K
		CODICE CODE	CODICE CODE	CODICE CODE
BIANCO INTONACO/WHITE	OPALE/OPAL	13G103T001	13G203T001	13G303T001
ALLUMINIO NATURALE/ALUMINUM		13G106T001	13G206T001	13G306T001

TESTATE DI CHIUSURA / DEAD ENDS

FINITURA STRUTTURA FINISHES	CODICE CODE
BIANCO INTONACO/WHITE	10304T03
ALLUMINIO NATURALE/ALUMINUM	10304T06

Il codice contiene 1 testata di chiusura con viti.
The code contains 1 closing warhead with screws.

ut02

led non integrato

not integrated led

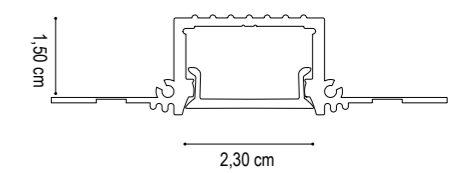
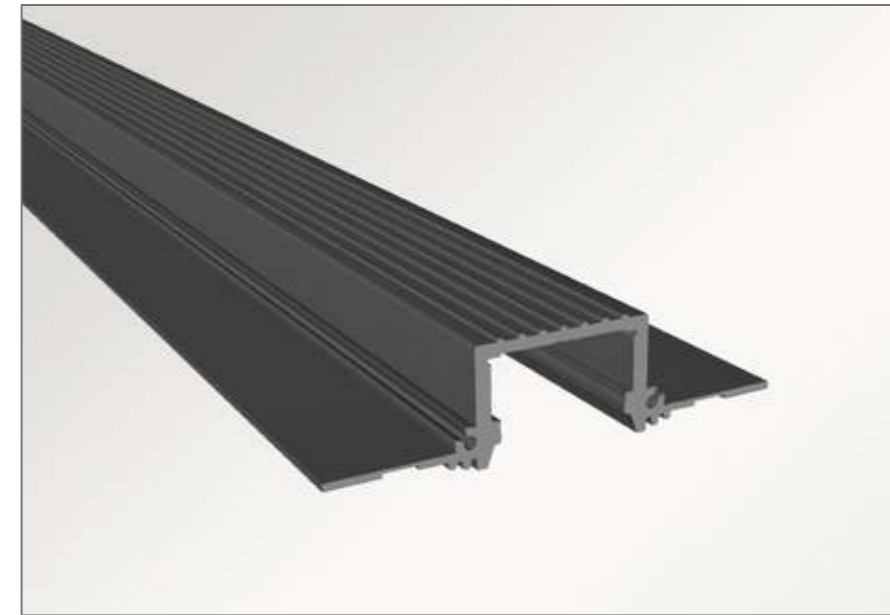

FINITURA STRUTTURA FINISHES	1 cm	200 cm	300 cm
	CODICE CODE	CODICE CODE	CODICE CODE
BIANCO INTONACO/WHITE	103T303001	103T303200	103T303300
ALLUMINIO NATURALE/ALUMINUM	103T306001	103T306200	103T306300

LAVORAZIONI / PROCESSING

DATI TECNICI TECHNICAL DATA	CODICE CODE
TAGLIO 90° ORIZZONTALE (PER ANGOLI FORMATI DA DUE PROFILI) HORIZONTAL 90 ° CUT (FOR CORNERS MADE OF TWO PROFILES)	190X
TAGLIO 90° VERTICALE (PER ANGOLI FORMATI DA DUE PROFILI) VERTICAL 90 ° CUT (FOR CORNERS MADE OF TWO PROFILES)	190Y
TAGLIO ANGOLARE CUSTOM (PER ANGOLI FORMATI DA DUE PROFILI) CUSTOM CORNER CUT (FOR CORNERS MADE OF TWO PROFILES)	190N
ASOLA / SLOT	100A
ASOLA CUSTOM / SLOT CUSTOM	100N
FORO / HOLE	100F
CABLAGGIO - COLLAUDO - CE AL CENTIMETRO INSTALLATION AND TESTING LED MODULE AT CENTIMETER	1031
CONNETTORE MASCHIO/FEMMINA MALE/FEMALE CONNECTOR	98CFM
CONNETTORE MASCHIO/FEMMINA MONTATO NEL PRODOTTO MALE/FEMALE CONNECTOR FITTED IN THE PRODUCT	98MFM
CAVO DI ALIMENTAZIONE 2X0,50 BIANCO 1CM POWER CABLE 2X0,50 WHITE 1CM	98CB001
CAVO DI ALIMENTAZIONE 2X0,50 NERO 1CM POWER CABLE 2X0,50 BLACK 1CM	98CN001
CAVO DI ALIMENTAZIONE 2X0,75 MARRONE 1CM POWER CABLE 2X0,75 BROWN 1CM	98CS001

“linee pulite ed essenziali”

Non sempre piccolo è sinonimo di inefficienza; nel nostro profilo U01 è racchiusa la massima espressione tecnologica dell'estrusione dell'alluminio finalizzata alla dissipazione termica. Luce morbida e diffusa grazie alla cover dedicata in policarbonato. Linee pulite ed essenziali.

Small is not always synonym for inefficiency, in our U01 profile is contained the highest expression of technology aimed at the aluminum extrusion heat dissipation. Soft and diffused light thanks to dedicated polycarbonate cover. Clean and essential lines.

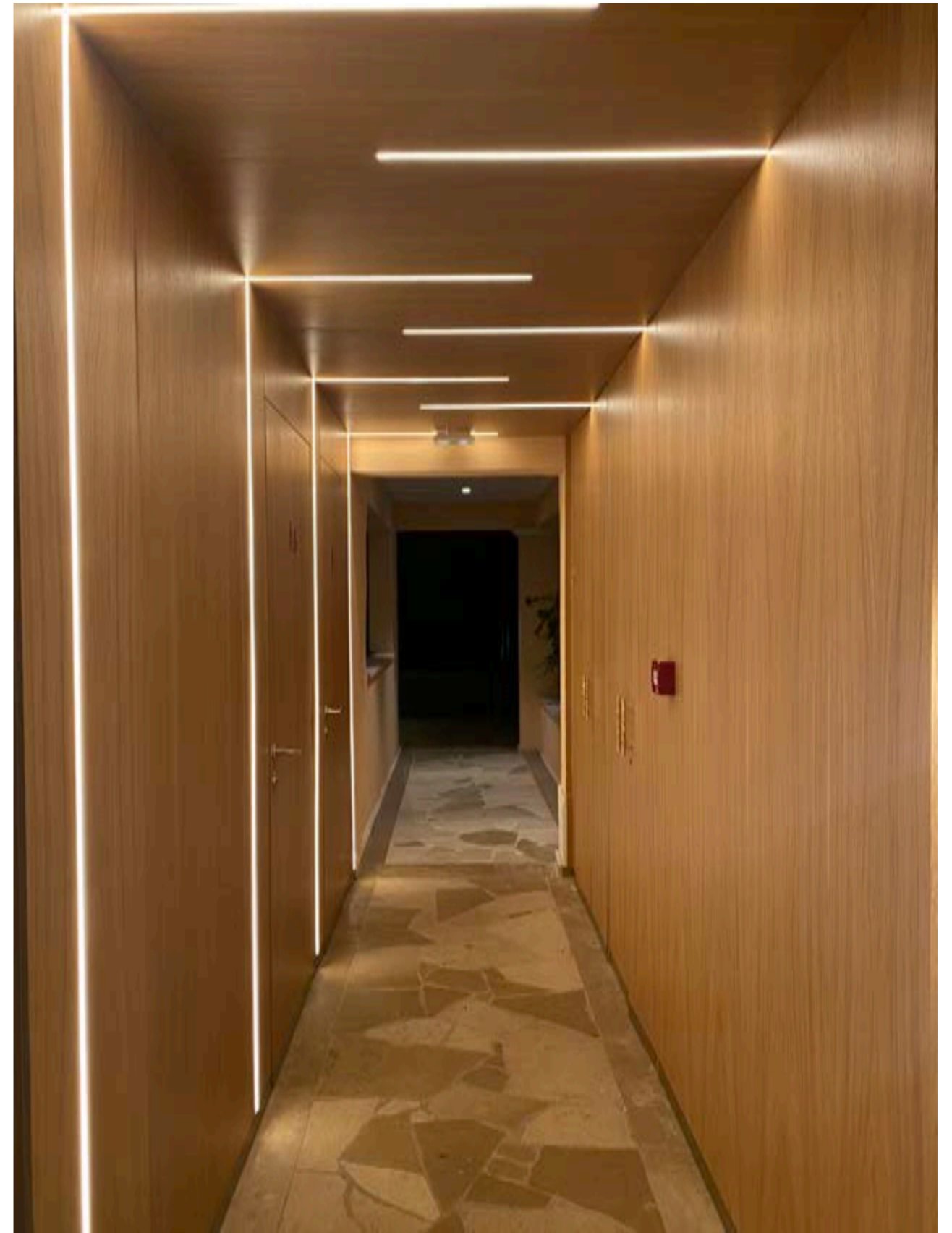

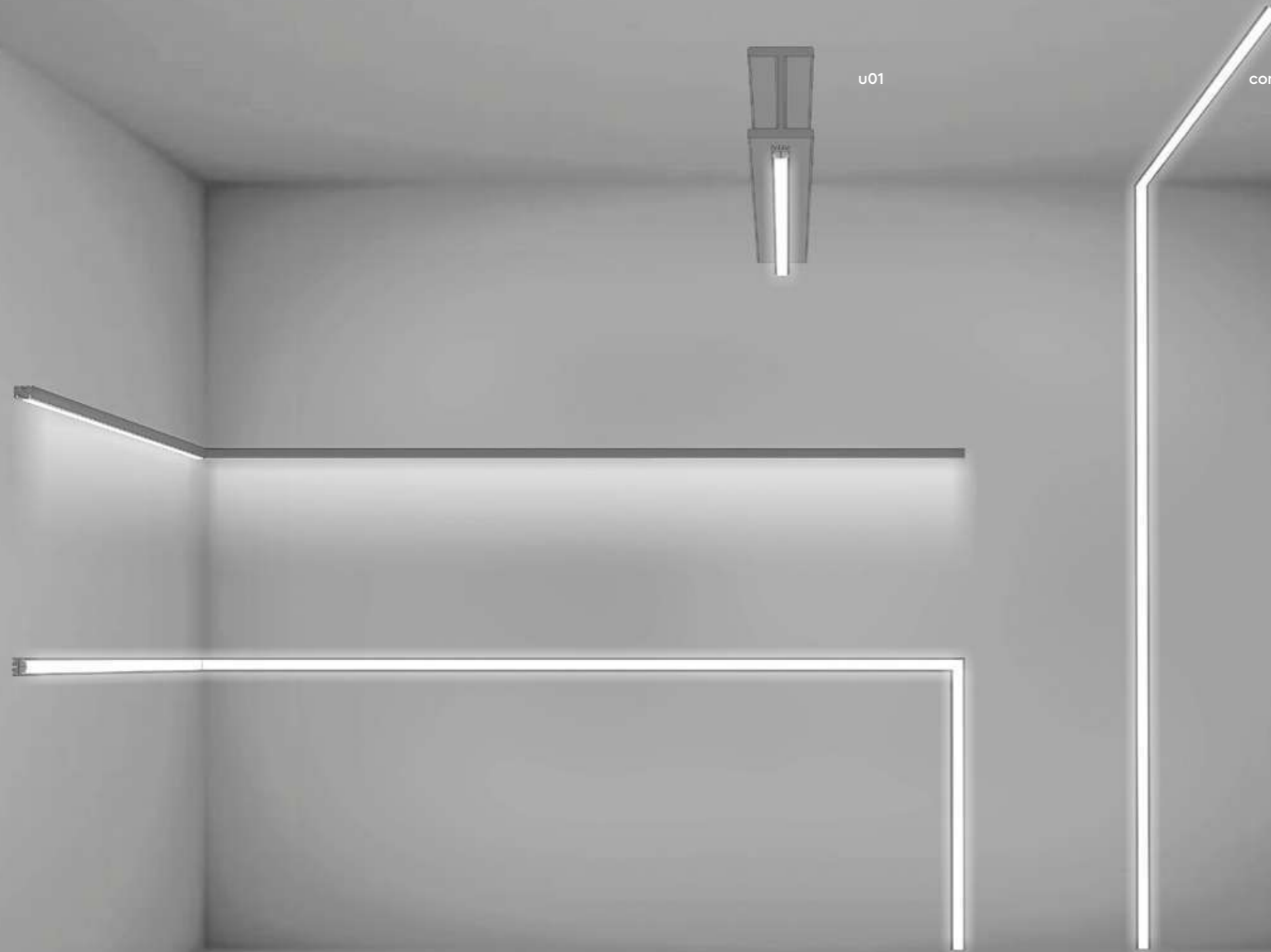

INSTALLAZIONE CON CLIP IN POLICARBONATO SU SUPERFICIE ORIZZONTALE
INSTALLATION WITH POLYCARBONATE CLIP ON HORIZONTAL SURFACE

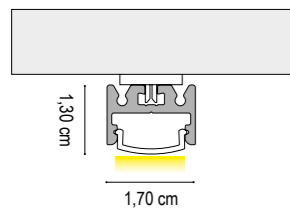

INSTALLAZIONE CON CLIP IN POLICARBONATO SU SUPERFICIE VERTICALE
INSTALLATION WITH POLYCARBONATE CLIP ON A VERTICAL SURFACE

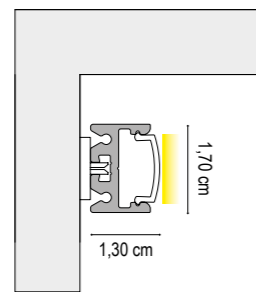

INSTALLAZIONE CON CALAMITA SU SUPERFICIE METALLICA ORIZZONTALE E VERTICALE
INSTALLATION WITH MAGNET ON HORIZONTAL AND VERTICAL METAL SURFACE

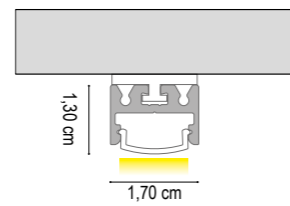

SI RACCOMANDA L'UTILIZZO DI N° 1 STAFFA MAGNETICA OGNI 25,00 cm DI PROFILO. TALE QUANTITÀ PUÒ VARIARE A SECONDA DELLA SUPERFICIE METALLICA DI INSTALLAZIONE.

WE RECOMMEND THE USE OF N° 1 MAGNETIC BRACKET EVERY 25.00 cm OF PROFILE. THIS QUANTITY MAY VARY DEPENDING ON THE METAL INSTALLATION SURFACE.

INSTALLAZIONE A PARETE
WALL INSTALLATION

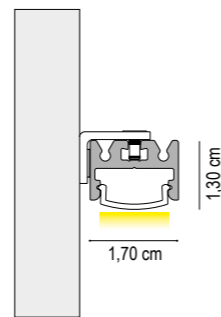

INSTALLAZIONE CON STAFFA PER INCASSO
INSTALLATION WITH BUILT-IN BRACKET

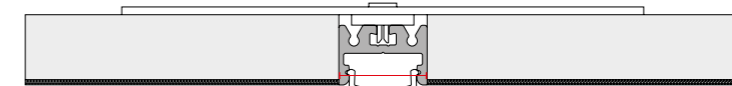

1,70 cm

INSTALLAZIONE AD INCASSO
LARGHEZZA TAGLIO L=2,60cm
RECESSED INSTALLATION
CUTTING WIDTH L=2,0cm

LE CONFIGURAZIONI SOPRA RIPORTATE SONO COMPATIBILI PER LA VERSIONE CON DIFFUSORE SEMITONDO E PER LA VERSIONE CON DIFFUSORE TONDO
THE CONFIGURATIONS SHOWN ABOVE ARE COMPATIBLE FOR THE VERSION WITH HALF-ROUND SPEAKER AND FOR THE VERSION WITH ROUND SPEAKER

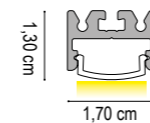

U01 CON DIFFUSORE SEMITONDO
U01 WITH HALF ROUND DIFFUSER

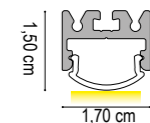

U01 CON DIFFUSORE TONDO
U01 WITH ROUND DIFFUSER

ATTENZIONE! GLI ACCESSORI PER L'INSTALLAZIONE A INCASSO SONO STATI DIMENSIONATI PER UN PANNELLO STANDARD IN CARTONGESSO DI SPESSORE 12,5 mm
WARNING! THE BUILT-IN INSTALLATION ACCESSORIES HAVE BEEN DIMENSIONED FOR A STANDARD PLASTERBOARD PANEL OF 12.5 mm THICKNESS

DATI TECNICI
TECHNICAL DATA

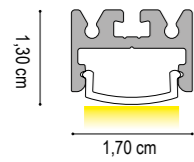

	1 cm	1 cm	1 cm
Nominal LED Flux:	2050 lm/m	2100 lm	2150 lm
Flux Tot:	1640 lm/m	1680 lm	1700 lm
Output:	110 lm/W	110 lm/W	110 lm/W
CCT:	2700 K	3000 K	4000 K
CRI:	>95	>95	>90
Power Tot:	20 W/m	20 W	20 W
Weight:	0.40 Kg/m	0.40 Kg/m	0.40 Kg/m

Alluminio/aluminium

Cover: Opale/opal

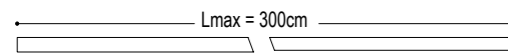

DRIVER NON INCLUSO / NOT INCLUDED

CAVO ALIMENTAZIONE : 50 cm
ALIMENTATION CABLE : 50cm

DATI TECNICI
TECHNICAL DATA

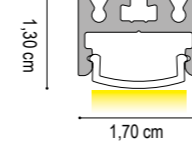

	1 cm	1 cm	1 cm
Nominal LED Flux:	1510 lm/m	1584 lm/m	1644 lm/m
Flux Tot:	1197 lm/m	1267 lm/m	1337 lm/m
Output:	105 lm/W	110 lm/W	115 lm/W
CCT:	2700 K	3000 K	4000 K
CRI:	>90	>90	>90
Power Tot:	14.4 W/m	14.4 W/m	14.4 W/m
Weight:	0.40 Kg/m	0.40 Kg/m	0.40 Kg/m

Alluminio/aluminum

Cover: Opale/opal

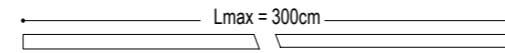

DRIVER NON INCLUSO / NOT INCLUDED

CAVO ALIMENTAZIONE : 50 cm
ALIMENTATION CABLE : 50cm

FINITURA STRUTTURA
FINISHES

- GRIGIO VESUVIO/ANTHRACITE
- ARGILLA/ARGIL
- ARGENTO OPACO/MATT SILVER
- BIANCO INTONACO/WHITE
- NERO CARAVAGGIO/BLACK
- MOKA/MOCHA
- ORO CALIFORNIA/GOLD
- ARAMEN/COPPER
- ARGENTO COMETA/SILVER COMET
- OTTONE VENEZIANO/BRASS
- TITANIO/TITANIUM
- BRONZO RIACI/RIACI BRONZE
- VERDE COSTA/GREEN COAST
- TERRA SENESE/SENESE EARTH
- CROMO/CHROME

DIFFUSORE
DIFFUSER

OPALE/OPAL

1 cm - 2700K 1 cm - 3000K 1 cm - 4000K

CODICE CODE	CODICE CODE	CODICE CODE
1012500001	1012600001	1012700001
1012501001	1012601001	1012701001
1012502001	1012602001	1012702001
1012503001	1012603001	1012703001
1012504001	1012604001	1012704001
1012505001	1012605001	1012705001
1012509001	1012609001	1012709001
1012510001	1012610001	1012710001
1012512001	1012612001	1012712001
1012513001	1012613001	1012713001
1012514001	1012614001	1012714001
1012515001	1012615001	1012715001
1012516001	1012616001	1012716001
1012517001	1012617001	1012717001
1012508001	1012608001	1012708001

ATTENZIONE/PLEASE NOTE: LUNGHEZZA MASSIMA VERSIONE CROMO = 2,00 m / MAXIMUM LENGTH CHROME VERSION = 2.00 m
TESTATE DI CHIUSURA NON INCLUSE / DEAD ENDS NOT INCLUDED

FINITURA STRUTTURA
FINISHES

- GRIGIO VESUVIO ANTHRACITE
- ARGILLA CLAY
- ARGENTO OPACO MATT SILVER
- BIANCO INTONACO/WHITE
- NERO CARAVAGGIO BLACK
- MOKA MOCHA
- CROMO/CHROME
- ORO CALIFORNIA/GOLD
- ARAMEN COPPER
- ARGENTO COMETA/SILVER COMET
- OTTONE VENEZIANO BRASS
- TITANIO/TITANIUM
- BRONZO RIACI/RIACI BRONZE
- VERDE COSTA/GREEN COAST
- TERRA SENESE SENESE EARTH

DIFFUSORE
DIFFUSER

OPALE/OPAL

1 cm - 2700K 1 cm - 3000K 1 cm - 4000K

CODICE CODE	CODICE CODE	CODICE CODE
101G100001	101G200001	101G300001
101G101001	101G201001	101G301001
101G102001	101G202001	101G302001
101G103001	101G203001	101G303001
101G104001	101G204001	101G304001
101G105001	101G205001	101G305001
101G108001	101G208001	101G308001
101G109001	101G209001	101G309001
101G110001	101G210001	101G310001
101G111001	101G211001	101G311001
101G113001	101G213001	101G313001
101G114001	101G214001	101G314001
101G115001	101G215001	101G315001
101G116001	101G216001	101G316001
101G117001	101G217001	101G317001

N.B./P.N.: LUNGHEZZA MASSIMA VERSIONE CROMO = 2,00 m / MAXIMUM LENGTH CHROME VERSION = 2.00 m
TESTATE DI CHIUSURA NON INCLUSE / DEAD ENDS NOT INCLUDED

u01

led non integrato
e cover semitonda opale

not integrated led
and half round opal diffuser

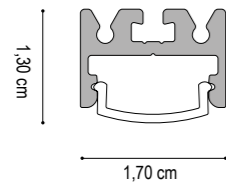

Diffusore in policarbonato
Polycarbonate diffuser

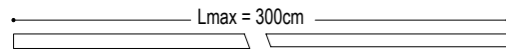

FINITURA STRUTTURA FINISHES	DIFFUSORE DIFFUSER	CODICE CODE		
		1 cm	200 cm	300 cm
GRIGIO VESUVIO/ANTHRACITE	OPALE/OPAL	101CP00001	101CP00200	101CP00300
ARGILLA/ARGIL		101CP01001	101CP01200	101CP01300
ARGENTO OPACO/MATT SILVER		101CP02001	101CP02200	101CP02300
BIANCO INTONACO/WHITE		101CP03001	101CP03200	101CP03300
NERO CARAVAGGIO/BLACK		101CP04001	101CP04200	101CP04300
MOKA/MOCHA		101CP05001	101CP05200	101CP05300
ALLUMINIO NATURALE/ALUMINUM		101CP06001	101CP06200	101CP06300
ORO CALIFORNIA/GOLD		101CP09001	101CP09200	101CP09300
ARAMEN/COPPER		101CP10001	101CP10200	101CP10300
ARGENTO COMETA/SILVER COMET		101CP12001	101CP12200	101CP12300
OTTONE VENEZIANO/BRASS		101CP13001	101CP13200	101CP13300
TITANIO/TITANIUM		101CP14001	101CP14200	101CP14300
BRONZO RIACI/RIACI BRONZE		101CP15001	101CP15200	101CP15300
VERDE COSTA/GREEN COAST		101CP16001	101CP16200	101CP16300
TERRA SENESE/SENESE EARTH		101CP17001	101CP17200	101CP17300
CROMO/CHROME		101CP08001	101CP08200	

ATTENZIONE/PLEASE NOTE: LUNGHEZZA MASSIMA VERSIONE CROMO = 2,00 m / MAXIMUM LENGTH CHROME VERSION = 2.00 m
TESTATE DI CHIUSURA NON INCLUSE / DEAD ENDS NOT INCLUDED

LED compatibili / LED compatibility

HIGH QUALITY CRI>90 CRI>95	HIGH OUTPUT CRI>90 CRI>95	HIGH EFFICIENT CRI>90 CRI>95	HIGH INTENSITY CRI>90 CRI>95	LOW POWER CRI>90	ULTRA SLIM CRI>90 CRI>95 CRI>97	RGB	RGB WHITE	RGB TW	TUNABLE WHITE
9,6W 14,4W 19,2W	12,3W 14,4W 19,2W 20W 24W	11,0W 12,3W 14,4W 19,2W 20W 24W	24W 24W (700 LED)	6W	7,0W 9,6W 12W 14,4W	14W	14W	14,4W 23W	19,2W



u01

led non integrato
e cover semitonda trasparente

not integrated led
and half round opal diffuser

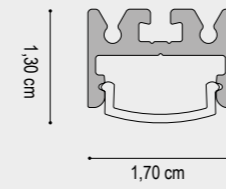

Diffusore in policarbonato
Polycarbonate diffuser

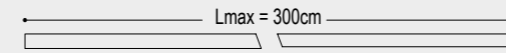

FINITURA STRUTTURA FINISHES	DIFFUSORE DIFFUSER	CODICE CODE		
		1 cm	200 cm	300 cm
GRIGIO VESUVIO/ANTHRACITE	TRASPARENTE TRANSPARENT	101CT00001	101CT00200	101CT00300
ARGILLA/ARGIL		101CT01001	101CT01200	101CT01300
ARGENTO OPACO/MATT SILVER		101CT02001	101CT02200	101CT02300
BIANCO INTONACO/WHITE		101CT03001	101CT03200	101CT03300
NERO CARAVAGGIO/BLACK		101CT04001	101CT04200	101CT04300
MOKA/MOCHA		101CT05001	101CT05200	101CT05300
ALLUMINIO NATURALE/ALUMINUM		101CT06001	101CT06200	101CT06300
ORO CALIFORNIA/GOLD		101CT09001	101CT09200	101CT09300
ARAMEN/COPPER		101CT10001	101CT10200	101CT10300
ARGENTO COMETA/SILVER COMET		101CT12001	101CT12200	101CT12300
OTTONE VENEZIANO/BRASS		101CT13001	101CT13200	101CT13300
TITANIO/TITANIUM		101CT14001	101CT14200	101CT14300
BRONZO RIACI/RIACI BRONZE		101CT15001	101CT15200	101CT15300
VERDE COSTA/GREEN COAST		101CT16001	101CT16200	101CT16300
TERRA SENESE/SENESE EARTH		101CT17001	101CT17200	101CT17300
CROMO/CHROME		101CT08001	101CT08200	

ATTENZIONE/PLEASE NOTE: LUNGHEZZA MASSIMA VERSIONE CROMO = 2,00 m / MAXIMUM LENGTH CHROME VERSION = 2.00 m
TESTATE DI CHIUSURA NON INCLUSE / DEAD ENDS NOT INCLUDED

LED compatibili / LED compatibility **NEW**

48V ONE CHIP CUT CRI>90 CRI>95	TWO CHIPS CUT CRI>90 CRI>95	SLIM ONE CHIP CUT CRI>90 CRI>95
8,0W 12,0W 19,2W	14,4W 24,0W	7,0W 9,0W 19,2W



u01

led non integrato
e cover tonda opale

not integrated led
and half round opal diffuser

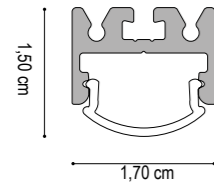

Diffusore in policarbonato
Polycarbonate diffuser

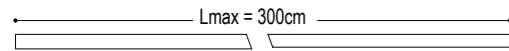

FINITURA STRUTTURA FINISHES	DIFFUSORE DIFFUSER	1 cm	200 cm	300 cm
		CODICE CODE	CODICE CODE	CODICE CODE
GRIGIO VESUVIO/ANTHRACITE	OPALE/OPAL	101CL00001	101CT00200	101CL00300
ARGILLA/ARGIL		101CL01001	101CL01200	101CL01300
ARGENTO OPACO/MATT SILVER		101CL02001	101CL02200	101CL02300
BIANCO INTONACO/WHITE		101CL03001	101CL03200	101CL03300
NERO CARAVAGGIO/BLACK		101CL04001	101CL04200	101CL04300
MOKA/MOCHA		101CL05001	101CL05200	101CL05300
ALLUMINIO NATURALE/ALUMINUM		101CL06001	101CL06200	101CL06300
ORO CALIFORNIA/GOLD		101CL09001	101CL09200	101CL09300
ARAMEN/COPPER		101CL10001	101CL10200	101CL10300
ARGENTO COMETA/SILVER COMET		101CL12001	101CL12200	101CL12300
OTTONE VENEZIANO/BRASS		101CL13001	101CL13200	101CL13300
TITANIO/TITANIUM		101CL14001	101CL14200	101CL14300
BRONZO RIACI/RIACI BRONZE		101CL15001	101CL15200	101CL15300
VERDE COSTA/GREEN COAST		101CL16001	101CL16200	101CL16300
TERRA SENESE/SENESE EARTH		101CL17001	101CL17200	101CL17300
CROMO/CHROME		101CL08001	101CL08200	

ATTENZIONE/PLEASE NOTE: LUNGHEZZA MASSIMA VERSIONE CROMO = 2,00 m / MAXIMUM LENGTH CHROME VERSION = 2.00 m
TESTATE DI CHIUSURA NON INCLUSE / DEAD ENDS NOT INCLUDED

LED compatibili / LED compatibility

HIGH QUALITY CRI>90 CRI>95	HIGH OUTPUT CRI>90 CRI>95	HIGH EFFICIENT CRI>90 CRI>95	HIGH INTENSITY CRI>90 CRI>95	LOW POWER CRI>90	ULTRA SLIM CRI>90 CRI>95 CRI>97	RGB	RGB WHITE	RGB TW	TUNABLE WHITE
9,6W 14,4W 19,2W	12,3W 14,4W 19,2W 20W 24W	11,0W 12,3W 14,4W 19,2W 20W 24W	24W 24W (700 LED)	6W	7,0W 9,6W 12W 14,4W	14W	14W	14,4W 23W	19,2W



u01

led non integrato
e cover tonda trasparente

not integrated led
and round transparent diffuser

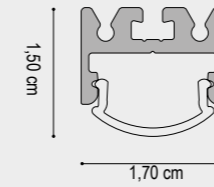

Diffusore in policarbonato
Polycarbonate diffuser

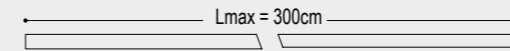

FINITURA STRUTTURA FINISHES	DIFFUSORE DIFFUSER	1 cm	200 cm	300 cm
		CODICE CODE	CODICE CODE	CODICE CODE
GRIGIO VESUVIO/ANTHRACITE	TRASPARENTE TRASPARENT	101CR00001	101CR00200	101CR00300
ARGILLA/ARGIL		101CR01001	101CR01200	101CR01300
ARGENTO OPACO/MATT SILVER		101CR02001	101CR02200	101CR02300
BIANCO INTONACO/WHITE		101CR03001	101CR03200	101CR03300
NERO CARAVAGGIO/BLACK		101CR04001	101CR04200	101CR04300
MOKA/MOCHA		101CR05001	101CR05200	101CR05300
ALLUMINIO NATURALE/ALUMINUM		101CR06001	101CR06200	101CR06300
ORO CALIFORNIA/GOLD		101CR09001	101CR09200	101CR09300
ARAMEN/COPPER		101CR10001	101CR10200	101CR10300
ARGENTO COMETA/SILVER COMET		101CR12001	101CR12200	101CR12300
OTTONE VENEZIANO/BRASS		101CR13001	101CR13200	101CR13300
TITANIO/TITANIUM		101CR14001	101CR14200	101CR14300
BRONZO RIACI/RIACI BRONZE		101CR15001	101CR15200	101CR15300
VERDE COSTA/GREEN COAST		101CR16001	101CR16200	101CR16300
TERRA SENESE/SENESE EARTH		101CR17001	101CR17200	101CR17300
CROMO/CHROME		101CR08001	101CR08200	

ATTENZIONE/PLEASE NOTE: LUNGHEZZA MASSIMA VERSIONE CROMO = 2,00 m / MAXIMUM LENGTH CHROME VERSION = 2.00 m
TESTATE DI CHIUSURA NON INCLUSE / DEAD ENDS NOT INCLUDED

LED compatibili / LED compatibility **NEW**

48V ONE CHIP CUT CRI>90 CRI>95	TWO CHIPS CUT CRI>90 CRI>95	SLIM ONE CHIP CUT CRI>90 CRI>95
8,0W 12,0W 19,2W	14,4W 24,0W	7,0W 9,0W 19,2W



u01

led non integrato
e cover piatta

not integrated led
and flat opal diffuser

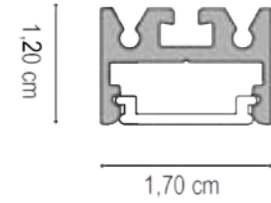

Lmax = 300 cm

Diffusore in policarbonato
Polycarbonate diffuser

FINITURA STRUTTURA FINISHES	DIFFUSORE DIFFUSER	CODICE CODE		
		1 cm	200 cm	300 cm
GRIGIO VESUVIO/ANTHRACITE	OPALE/OPAL	101CB00001	101CB00200	101CB00300
ARGILLA/ARGIL		101CB01001	101CB01200	101CB01300
ARGENTO OPACO/MATT SILVER		101CB02001	101CB02200	101CB02300
BIANCO INTONACO/WHITE		101CB03001	101CB03200	101CB03300
NERO CARAVAGGIO/BLACK		101CB04001	101CB04200	101CB04300
MOKA/MOCHA		101CB05001	101CB05200	101CB05300
ALLUMINIO NATURALE/ALUMINUM		101CB06001	101CB06200	101CB06300
ORO CALIFORNIA/GOLD		101CB09001	101CB09200	101CB09300
ARAMEN/COPPER		101CB10001	101CB10200	101CB10300
ARGENTO COMETA/SILVER COMET		101CB12001	101CB12200	101CB12300
OTTONE VENEZIANO/BRASS		101CB13001	101CB13200	101CB13300
TITANIO/TITANIUM		101CB14001	101CB14200	101CB14300
BRONZO RIACI/RIACI BRONZE		101CB15001	101CB15200	101CB15300
VERDE COSTA/GREEN COAST		101CB16001	101CB16200	101CB16300
TERRA SENESE/SENESE EARTH		101CB17001	101CB17200	101CB17300
CROMO/CHROME		101CB08001	101CB08200	

ATTENZIONE/PLEASE NOTE: LUNGHEZZA MASSIMA VERSIONE CROMO = 2,00 m / MAXIMUM LENGTH CHROME VERSION = 2.00 m
TESTATE DI CHIUSURA NON INCLUDE / DEAD ENDS NOT INCLUDED





TESTATE SEMITONDE / HALF ROUNDED ENDS nb : testate per versione CP e CT



FINITURA STRUTTURA FINISHES	CODICE CODE	FINITURA STRUTTURA FINISHES	CODICE CODE
GRIGIO VESUVIO/ANTHRACITE	1010400000	ORO CALIFORNIA/GOLD	1010409000
ARGILLA/ARGIL	1010401000	ARAMEN/COPPER	1010410000
ARGENTO OPACO/MATT SILVER	1010402000	ARGENTO COMETA/SILVER COMET	1010412000
BIANCO INTONACO/WHITE	1010403000	OTTONE VENEZIANO/BRASS	1010413000
NERO CARAVAGGIO/BLACK	1010404000	TITANIO/TITANIUM	1010414000
MOKA/MOCHA	1010405000	BRONZO RIACI/RIACI BRONZE	1010415000
ALLUMINIO NATURALE/ALUMINUM	1010406000	VERDE COSTA/GREEN COAST	1010416000
CROMO/CHROME	1010408000	TERRA SENESE/SENESE EARTH	1010417000

Il codice contiene 1 testata di chiusura con viti.
The code contains 1 closing warhead with screws.

TESTATE TONDE/ ROUNDED DEAD ENDS nb : testate per versione CL e CR



FINITURA STRUTTURA FINISHES	CODICE CODE	FINITURA STRUTTURA FINISHES	CODICE CODE
GRIGIO VESUVIO/ANTHRACITE	1010500000	ORO CALIFORNIA/GOLD	1010509000
ARGILLA/ARGIL	1010501000	ARAMEN/COPPER	1010510000
ARGENTO OPACO/MATT SILVER	1010502000	ARGENTO COMETA/SILVER COMET	1010512000
BIANCO INTONACO/WHITE	1010503000	OTTONE VENEZIANO/BRASS	1010513000
NERO CARAVAGGIO/BLACK	1010504000	TITANIO/TITANIUM	1010514000
MOKA/MOCHA	1010505000	BRONZO RIACI/RIACI BRONZE	1010515000
ALLUMINIO NATURALE/ALUMINUM	1010506000	VERDE COSTA/GREEN COAST	1010516000
CROMO/CHROME	1010508000	TERRA SENESE/SENESE EARTH	1010517000

Il codice contiene 1 testata di chiusura con viti.
The code contains 1 closing warhead with screws.

TESTATE PIATTE /FLAT DEAD ENDS nb: testate per versione CB



FINITURA STRUTTURA FINISHES	CODICE CODE	FINITURA STRUTTURA FINISHES	CODICE CODE
GRIGIO VESUVIO/ANTHRACITE	1010600000	ORO CALIFORNIA/GOLD	1010609000
ARGILLA/ARGIL	1010601000	ARAMEN/COPPER	1010610000
ARGENTO OPACO/MATT SILVER	1010602000	ARGENTO COMETA/SILVER COMET	1010612000
BIANCO INTONACO/WHITE	1010603000	OTTONE VENEZIANO/BRASS	1010613000
NERO CARAVAGGIO/BLACK	1010604000	TITANIO/TITANIUM	1010614000
MOKA/MOCHA	1010605000	BRONZO RIACI/RIACI BRONZE	1010615000
ALLUMINIO NATURALE/ALUMINUM	1010606000	VERDE COSTA/GREEN COAST	1010616000
CROMO/CHROME	1010608000	TERRA SENESE/SENESE EARTH	1010617000

Il codice contiene 1 testata di chiusura con viti.
The code contains 1 closing warhead with screws.

GIUNTI / JOINTS

GIUNTO LINEA CONTINUA / STRAIGHT JOINT

Accessorio per giunzioni meccaniche lineari
Accessory for linear mechanical joints

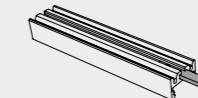

FINITURA FINISHES	CODICE CODE
ALLUMINIO NATURALE/ALUMINUM	1010500006

GIUNTO 90° ORIZZONTALE / HORIZONTAL JOINT 90°

Accessorio per giunzioni meccaniche con angolo 90°
Accessory for linear mechanical joints with 90° angle

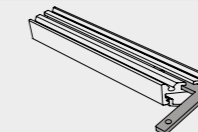

FINITURA FINISHES	CODICE CODE
ALLUMINIO NATURALE/ALUMINUM	1010500005

GIUNTO 90° VERTICALE / VERTICAL JOINT 90°

Accessorio per giunzioni meccaniche con angolo 90°
Accessory for linear mechanical joints with 90° angle

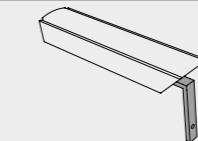

FINITURA FINISHES	CODICE CODE
ALLUMINIO NATURALE/ALUMINUM	1010500007

Il codice contiene i grani per il fissaggio del giunto.
The code contains the grains to fix the joint.

STAFFA DI FISSAGGIO A PARETE / WALL MOUNTING CLIP

DATI TECNICI
TECHNICAL DATA

MATERIALE: Alluminio naturale
MATERIAL: Natural aluminum

Il codice comprende n°2 staffe con asole.
The code includes n°2 wall brackets whit holes.

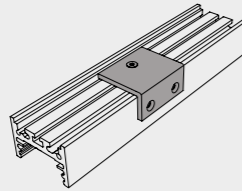

FINITURA STRUTTURA
FINISHES

GRIGIO VESUVIO/ANTHRACITE	1010500003
ARGILLA/ARGIL	1010501003
ARGENTO OPACO/MATT SILVER	1010502003
BIANCO INTONACO/WHITE	1010503003
NERO CARAVAGGIO/BLACK	1010504003
MOKA/MOCHA	1010505003
ORO CALIFORNIA/GOLD	1010509003
ARAMEN/COPPER	1010510003
ARGENTO COMETA/SILVER COMET	1010712003
OTTONE VENEZIANO/BRASS	1010713003
TITANIO/TITANIUM	1010714003
BRONZO RIACI/RIACI BRONZE	1010715003
VERDE COSTA/GREEN COAST	1010716003
TERRA SENESE/SENESE EARTH	1010517003

CODICE
CODE

STAFFA DI FISSAGGIO A DOPPIO ATTACCO / DOUBLE MOUNTING CLIP

FINITURA
FINISHES

SUPERFICI PIANE 2mm EVEN SURFACE 2mm	1020500005
SUPERFICI IRREGOLARI 3,9mm UNEVEN SURFACE 3,9mm	1020500006

CODICE
CODE

CODICE
CODE

PORTATA
RANGE

1020500010	1 Kg
1020500210	2 Kg



Accessorio per fissaggio a plafone/superficie. Quantità raccomandata: 1 pz ogni 50 cm di modello.

Ceiling/surface mounting accessory. Recommended quantity 1 pc every 50 cm of model.

Quantità raccomandata: 1 pz ogni 25 cm di modello.

Recommended quantity: 1 pc every 25 cm of model.

FINITURA STRUTTURA
FINISHES

ALLUMINIO NATURALE/ALUMINUM	1090500001
-----------------------------	------------

CODICE
CODE

DATI TECNICI
TECHNICAL DATA

Accessorio che consente l'incasso del modello.
Accessory that allows the collection of the model.

Nel codice sono comprese le viti per il fissaggio del modello alla staffa. The code includes screws for fixing their model to the bracket.

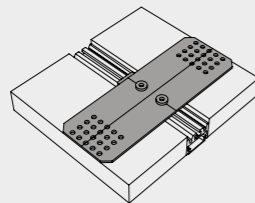

DATI TECNICI
TECHNICAL DATA

ARTICOLI INCLUSI NEL CODICE
ARTICLES INCLUDED IN THE CODE

N°2 testate di chiusura / No. 2 closing heads
N°3 staffe di fissaggio per superfici irregolari 3mm
No. 3 fixing brackets for uneven surfaces 3mm

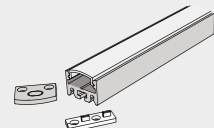

FINITURA
FINISHES

ARGENTO OPACO/MATT SILVER
BIANCO INTONACO/WHITE
NERO CARAVAGGIO/BLACK
ARGENTO OPACO/MATT SILVER
BIANCO INTONACO/WHITE
NERO CARAVAGGIO/BLACK

DIFFUSORE
DIFFUSER

OPALE/OPAL
TRASPARENTE TRANSPARENT

200 cm 300 cm

CODICE CODE	CODICE CODE
101P22	101P23
101P32	101P33
101P42	101P43
101T22	101T23
101T32	101T33
101T42	101T43

INTERRUTTORE DIMMERABILE / DIMMABLE SWITCH

DATI TECNICI
TECHNICAL DATA

Accessorio che consente l'accensione e lo spegnimento dei LED e, a seconda della pressione, la regolazione dell'intensità luminosa.
Accessory that allows the switching on and off of the LEDs and, depending on the pressure, the regulation of the light intensity.

Tensione di alimentazione: 12-24V DC
Supply voltage: 12-24V DC
Corrente d'uscita: 4A max
Output current: 4A max
ON / OFF: contact < 0.7 s
DIMMER: contact > 0.7 s

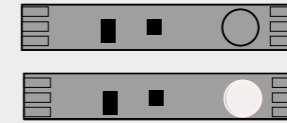

FINITURA STRUTTURA
FINISHES

INTERRUTTORE DIMMERABILE	98243
INTERRUTTORE PIR	98245

CODICE
CODE

INTERRUTTORE DIMMERABILE+INSTALLAZIONE / DIMMABLE SWITCH+INSTALLATION

DATI TECNICI
TECHNICAL DATA

Accessorio che consente l'accensione e lo spegnimento dei LED e, a seconda della pressione, la regolazione dell'intensità luminosa.
Accessory that allows the switching on and off of the LEDs and, depending on the pressure, the regulation of the light intensity.

Tensione di alimentazione: 12-24V DC
Supply voltage: 12-24V DC
Corrente d'uscita: 4A max
Output current: 4A max
ON / OFF: contact < 0.7 s
DIMMER: contact > 0.7 s

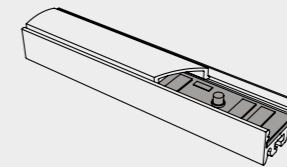

FINITURA STRUTTURA
FINISHES

ALLUMINIO NATURALE/ALUMINUM	98244
-----------------------------	-------

CODICE
CODE

LAVORAZIONI / PROCESSING

DATI TECNICI
TECHNICAL DATA

TAGLIO 90° ORIZZONTALE (PER ANGOLI FORMATI DA DUE PROFILI)
HORIZONTAL 90 ° CUT (FOR CORNERS MADE OF TWO PROFILES)

CODICE
CODE

190X



TAGLIO 90° VERTICALE (PER ANGOLI FORMATI DA DUE PROFILI)
VERTICAL 90 ° CUT (FOR CORNERS MADE OF TWO PROFILES)

190Y



TAGLIO ANGOLARE CUSTOM (PER ANGOLI FORMATI DA DUE PROFILI)
CUSTOM CORNER CUT (FOR CORNERS MADE OF TWO PROFILES)

190N



ASOLA / SLOT

100A



ASOLA CUSTOM / SLOT CUSTOM

100N



FORO / HOLE

100F

CABLAGGIO - COLLAUDO - CE AL CENTIMETRO
INSTALLATION AND TESTING LED MODULE AT CENTIMETER

1011

CABLAGGIO - COLLAUDO CE - MONTAGGIO LED IP AL CENTIMETRO
INSTALLATION - TESTING LED CE - ASSEMBLY LED IP AT CENTIMETER-

1016

CONNETTORE MASCHIO/FEMMINA
MALE/FEMALE CONNECTOR

98CFM

CONNETTORE MASCHIO/FEMMINA MONTATO NEL PRODOTTO
MALE/FEMALE CONNECTOR FITTED IN THE PRODUCT

98MFM

CAVO DI ALIMENTAZIONE 2X0,50 BIANCO 1CM
POWER CABLE 2X0,50 WHITE 1CM

98CB001

CAVO DI ALIMENTAZIONE 2X0,50 NERO 1CM
POWER CABLE 2X0,50 BLACK 1CM

98CN001

CAVO DI ALIMENTAZIONE 2X0,75 MARRONE 1CM
POWER CABLE 2X0,75 BROWN 1CM

98CS001

u02

u02 spot

**“semplicità,
l'essenza delle forme e praticità”**

U02 è frutto di una ricerca che tende ad abbinare la semplicità e l'essenza delle forme alla praticità delle nostre idee. Concetti illuminotecnici tradizionali si sposano alla perfezione con la nuova tecnologia LED, tutto questo per garantire il massimo rispetto dell'ambiente.

U02 è una soluzione discreta ed efficiente in tutti quei campi dove la luce è chiamata ad esaltare e valorizzare gli ambienti e i prodotti, arreda con discrezione sia gli spazi a te più cari e familiari che i luoghi più formali.

U02 is the result of our continuous research for combining essence and simplicity of forms, with the particularity of our ideas. Traditional lighting concepts are blended with new LED technology in the respect of the environment. U02 is a discrete and efficient solution in all the situations where light is necessary for enhancing products and interiors. U02 decorate with discretion whether your familiar spaces than formal places.

u02
u02 spot

designer

luigi cerbone



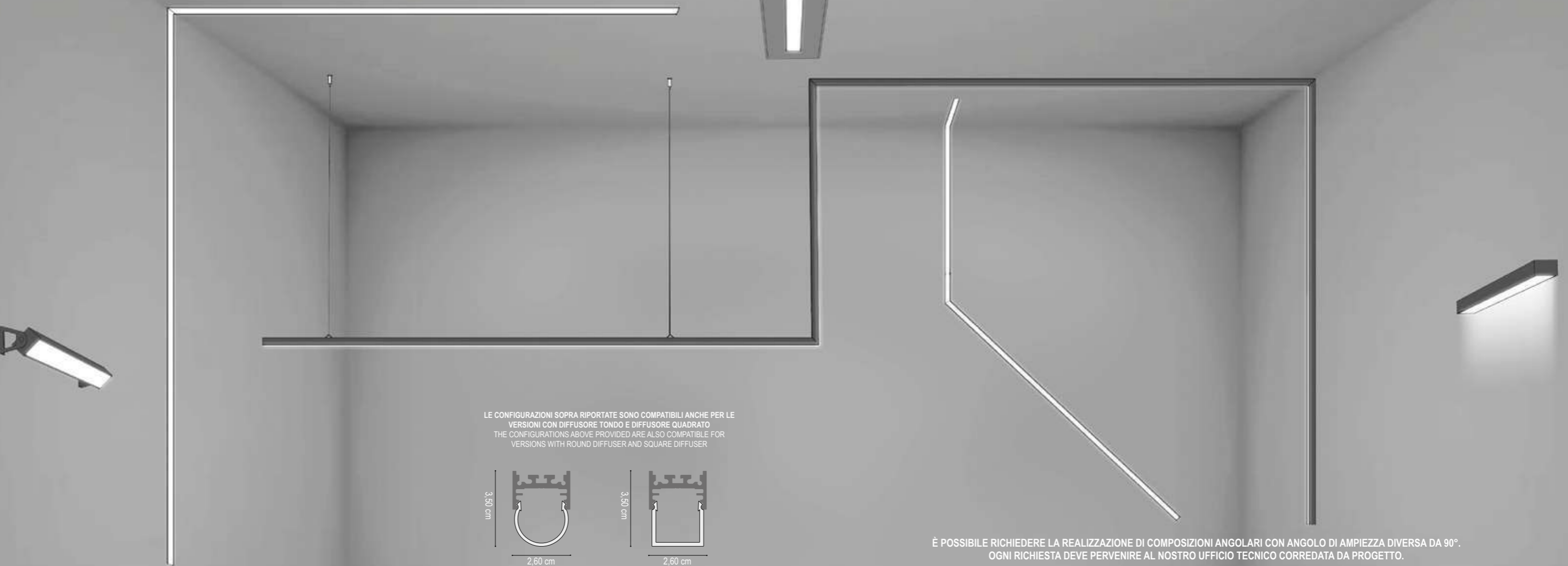

LE CONFIGURAZIONI SOPRA RIPORTATE SONO COMPATIBILI ANCHE PER LE VERSIONI CON DIFFUSORE TONDO E DIFFUSORE QUADRATO
 THE CONFIGURATIONS ABOVE PROVIDED ARE ALSO COMPATIBLE FOR VERSIONS WITH ROUND DIFFUSER AND SQUARE DIFFUSER

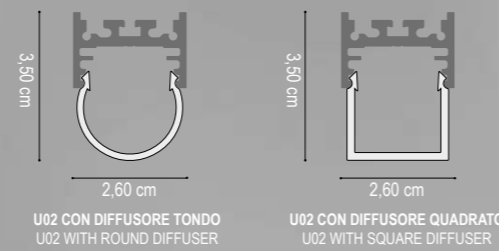

È POSSIBILE RICHIEDERE LA REALIZZAZIONE DI COMPOSIZIONI ANGOLARI CON ANGOLO DI AMPIEZZA DIVERSA DA 90°.
 OGNI RICHIESTA DEVE PERVENIRE AL NOSTRO UFFICIO TECNICO CORREDATA DA PROGETTO.
 IT IS POSSIBLE TO REQUEST THE CREATION OF ANGULAR COMPOSITIONS WITH AN ANGLE OF DIFFERENT 90°.
 EVERY REQUEST MUST COME TO OUR TECHNICAL OFFICE WITH PROJECT.

INSTALLAZIONE A SOSPENSIONE
SUSPENSION

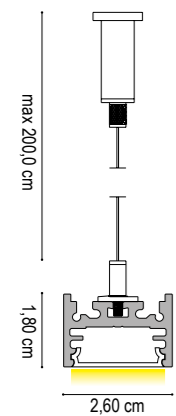

INSTALLAZIONE CON CLIP IN POLICARBONATO SU SUPERFICIE ORIZZONTALE
 INSTALLATION WITH POLYCARBONATE CLIP ON HORIZONTAL SURFACE

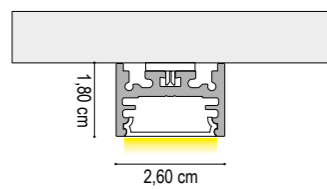

INSTALLAZIONE CON CALAMITA SU SUPERFICIE METALLICA ORIZZONTALE E VERTICALE
 INSTALLATION WITH MAGNET ON HORIZONTAL AND VERTICAL METAL SURFACE

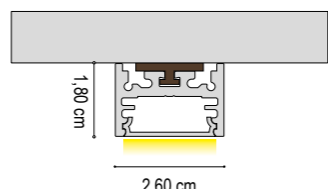

SI RACCOMANDA L'UTILIZZO DI N° 1 STAFFA MAGNETICA OGNI 25,00 cm DI PROFILO. TALE QUANTITÀ PUÒ VARIARE A SECONDA DELLA SUPERFICIE METALLICA DI INSTALLAZIONE.

WE RECOMMEND THE USE OF N° 1 MAGNETIC BRACKET EVERY 25.00 cm OF PROFILE. THIS QUANTITY MAY VARY DEPENDING ON THE METAL INSTALLATION SURFACE.

INSTALLAZIONE CON CLIP IN POLICARBONATO SU SUPERFICIE VERTICALE
 INSTALLATION WITH POLYCARBONATE CLIP ON A VERTICAL SURFACE

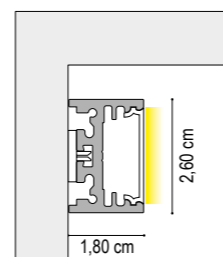

INSTALLAZIONE A SOSPENSIONE
SUSPENSION

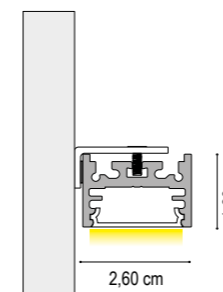

INSTALLAZIONE CON CLIP IN POLICARBONATO SU SUPERFICIE ORIZZONTALE
 INSTALLATION WITH POLYCARBONATE CLIP ON HORIZONTAL SURFACE

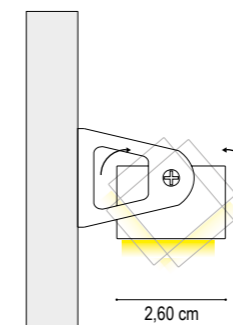

INSTALLAZIONE CON STAFFA PER SEMI INCASSO
 INSTALLATION WITH BUILT-IN BRACKET

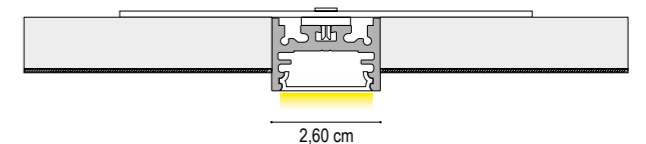

INSTALLAZIONE CON STAFFA PER INCASSO
 INSTALLATION WITH BUILT-IN BRACKET

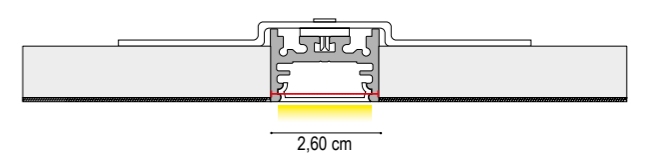

ATTENZIONE! GLI ACCESSORI PER L'INSTALLAZIONE A INCASSO SONO STATI DIMENSIONATI PER UN PANNELLO STANDARD IN CARTONGESSO DI SPESSORE 12,5 mm
 WARNING! THE BUILT-IN INSTALLATION ACCESSORIES HAVE BEEN DIMENSIONED FOR A STANDARD PLASTERBOARD PANEL OF 12.5 mm THICKNESS

INSTALLAZIONE AD INCASSO
 LARGHEZZA TAGLIO L=2,60cm
 RECESSED INSTALLATION
 CUTTING WIDTH L=2.0cm

DATI TECNICI
TECHNICAL DATA

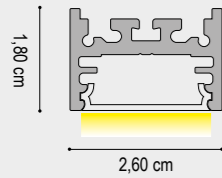

	1 cm	1 cm	1 cm
Nominal LED Flux:	2050 lm/m	2100 lm/m	2200 lm/m
Flux Tot:	1845 lm/m	2000 lm/m	1980 lm/m
Output:	102 lm/W	105 lm/W	110 lm/W
CCT:	2700 K	3000 K	4000 K
CRI:	>90	>90	>90
Power Tot:	20 W/m	20 W/m	20 W/m
Weight:	0.50 Kg/m	0.50 Kg/m	0.50 Kg/m

Alluminio/aluminium Cover: Opale/opal

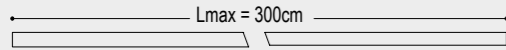

DRIVER NON INCLUSO / NOT INCLUDED

CAVO ALIMENTAZIONE : 50 cm
ALIMENTATION CABLE : 50cm

FINITURA STRUTTURA
FINISHES

- GRIGIO VESUVIO/ANTHRACITE
- ARGILLA/ARGIL
- ARGENTO OPACO/MATT SILVER
- BIANCO INTONACO/WHITE
- NERO CARAVAGGIO/BLACK
- MOKA/MOCHA
- ORO CALIFORNIA/GOLD
- ARAMEN/COPPER
- GRIGIO AVIO/GREY AVIO
- ARGENTO COMETA/SILVER COMET
- OTTONE VENEZIANO/BRASS
- TITANIO/TITANIUM
- BRONZO RIACI/RIACI BRONZE
- VERDE COSTA/GREEN COAST
- TERRA SENESE/SENESE EARTH
- CROMO/CHROME

DIFFUSORE
DIFFUSER

PRISMATIZZATO
PRISMATIC

	1 cm - 2700K	1 cm - 3000K	1 cm - 4000K
CODICE CODE	1032500301	1032600301	1032700301
	1032501301	1032601301	1032701301
	1032502301	1032602301	1032702301
	1032503301	1032603301	1032703301
	1032504301	1032604301	1032704301
	1032505301	1032605301	1032705301
	1032509301	1032609301	1032709301
	1032510301	1032610301	1032710301
	1032511301	1032611301	1032711301
	1032512301	1032612301	1032712301
	1032513301	1032613301	1032713301
	1032514301	1032614301	1032714301
	1032515301	1032615301	1032715301
	1032516301	1032616301	1032716301
	1032517301	1032617301	1032717301
	1032508301	1032608301	1032718301

ATTENZIONE/PLEASE NOTE: LUNGHEZZA MASSIMA VERSIONE CROMO = 2,00 m / MAXIMUM LENGTH CHROME VERSION = 2.00 m
TESTATE DI CHIUSURA NON INCLUSE / DEAD ENDS NOT INCLUDED

DATI TECNICI
TECHNICAL DATA

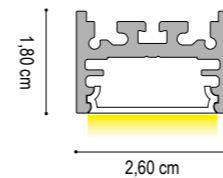

	1 cm	1 cm	1 cm
Nominal LED Flux:	2050 lm/m	2100 lm/m	2200 lm/m
Flux Tot:	1640 lm/m	1680 lm/m	1760 lm/m
Output:	102 lm/W	105 lm/W	110 lm/W
CCT:	2700 K	3000 K	4000 K
CRI:	>90	>90	>90
Power Tot:	20 W/m	20 W/m	20 W/m
Weight:	0.50 Kg/m	0.50 Kg/m	0.50 Kg/m

Alluminio/aluminium Cover: Opale/opal

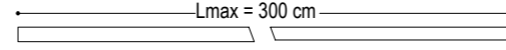

DRIVER NON INCLUSO / NOT INCLUDED

CAVO ALIMENTAZIONE : 50 cm
ALIMENTATION CABLE : 50cm

FINITURA STRUTTURA
FINISHES

- GRIGIO VESUVIO/ANTHRACITE
- ARGILLA/ARGIL
- ARGENTO OPACO/MATT SILVER
- BIANCO INTONACO/WHITE
- NERO CARAVAGGIO/BLACK
- MOKA/MOCHA
- ORO CALIFORNIA/GOLD
- ARAMEN/COPPER
- GRIGIO AVIO/GREY AVIO
- ARGENTO COMETA/SILVER COMET
- OTTONE VENEZIANO/BRASS
- TITANIO/TITANIUM
- BRONZO RIACI/RIACI BRONZE
- VERDE COSTA/GREEN COAST
- TERRA SENESE/SENESE EARTH
- CROMO/CHROME

DIFFUSORE
DIFFUSER

OPALE/OPAL

	1 cm - 2700K	1 cm - 3000K	1 cm - 4000K
CODICE CODE	1032500001	1032600001	1032700001
	1032501001	1032601001	1032701001
	1032502001	1032602001	1032702001
	1032503001	1032603001	1032703001
	1032504001	1032604001	1032704001
	1032505001	1032605001	1032705001
	1032509001	1032609001	1032709001
	1032510001	1032610001	1032710001
	1032511001	1032611001	1032711001
	1032512001	1032612001	1032712001
	1032513001	1032613001	1032713001
	1032514001	1032614001	1032714001
	1032515001	1032615001	1032715001
	1032516001	1032616001	1032716001
	1032517001	1032617001	1032717001
	1032508001	1032608001	1032718001

ATTENZIONE/PLEASE NOTE: LUNGHEZZA MASSIMA VERSIONE CROMO = 2,00 m / MAXIMUM LENGTH CHROME VERSION = 2.00 m
TESTATE DI CHIUSURA NON INCLUSE / DEAD ENDS NOT INCLUDED

DATI TECNICI
TECHNICAL DATA

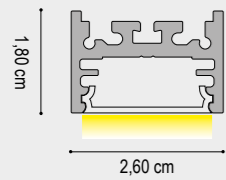

	1 cm	1 cm	1 cm
Nominal LED Flux:	3680 lm/m	4000 lm/m	4160 lm/m
Flux Tot:	2944 lm/m	3200 lm/m	3328 lm/m
Output:	115 lm/W	125 lm/W	130 lm/W
CCT:	2700 K	3000 K	4000 K
CRI:	>90	>90	>90
Power Tot:	32.0 W/m	32.0 W/m	32.0 W/m
Weight:	0.50 Kg/m	0.50 Kg/m	0.50 Kg/m

Alluminio/aluminium Cover: Opale/opal

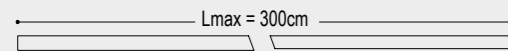

DRIVER NON INCLUSO / NOT INCLUDED

CAVO ALIMENTAZIONE : 50 cm
ALIMENTATION CABLE : 50 cm

FINITURA STRUTTURA
FINISHES

- GRIGIO VESUVIO ANTHRACITE
- ARGILLA CLAY
- ARGENTO OPACO/MATT SILVER
- BIANCO INTONACO/WHITE
- NERO CARAVAGGIO/BLACK
- MOKA MOCHA
- CROMO/CHROME
- ORO CALIFORNIA/GOLD
- ARAMEN COPPER
- GRIGIO AVIO/GREY AVIO
- ARGENTO COMETA/SILVER COMET
- OTTONE VENEZIANO/BRASS
- TITANIO/TITANIUM
- BRONZO RIACI/RIACI BRONZE
- VERDE COSTA/GREEN COAST
- TERRA SENESE/SENESE EARTH

DIFFUSORE
DIFFUSER

OPALE/OPAL

	1 cm - 2700K	1 cm - 3000K	1 cm - 4000K
CODICE CODE	103J200001	103J300001	103J400001
	103J201001	103J301001	103J401001
	103J202001	103J302001	103J402001
	103J203001	103J303001	103J403001
	103J204001	103J304001	103J404001
	103J205001	103J305001	103J405001
	103J208001	103J308001	103J408001
	103J209001	103J309001	103J409001
	103J210001	103J310001	103J410001
	103J211001	103J311001	103J411001
	103J212001	103J312001	103J412001
	103J213001	103J313001	103J413001
	103J214001	103J314001	103J414001
	103J215001	103J315001	103J415001
	103J216001	103J316001	103J416001
	103J217001	103J317001	103J417001

N.B./P.N.:
LUNGHEZZA MASSIMA VERSIONE CROMO = 2,00 m / MAXIMUM LENGTH CHROME VERSION = 2.00 m
TESTATE NON INCLUSE / DEAD ENDS NOT INCLUDED

DATI TECNICI
TECHNICAL DATA

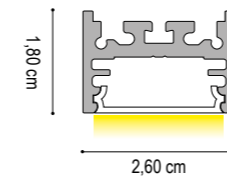

	1 cm	1 cm	1 cm
Nominal LED Flux:	2820 lm/m	2975 lm/m	3100 lm/m
Flux Tot:	2260 lm/m	2380 lm/m	2640 lm/m
Output:	125 lm/W	125 lm/W	125 lm/W
CCT:	2700 K	3000 K	4000 K
CRI:	>90	>90	>90
Power Tot:	23.0 W/m	23.0 W/m	23.0 W/m
Weight:	0.50 Kg/m	0.50 Kg/m	0.50 Kg/m

Alluminio/aluminium Cover: Opale/opal

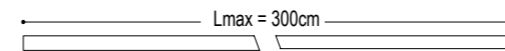

DRIVER NON INCLUSO / NOT INCLUDED

CAVO ALIMENTAZIONE : 50 cm
ALIMENTATION CABLE : 50 cm

FINITURA STRUTTURA
FINISHES

- GRIGIO VESUVIO ANTHRACITE
- ARGILLA CLAY
- ARGENTO OPACO/MATT SILVER
- BIANCO INTONACO/WHITE
- NERO CARAVAGGIO/BLACK
- MOKA MOCHA
- CROMO/CHROME
- ORO CALIFORNIA/GOLD
- ARAMEN COPPER
- GRIGIO AVIO/GREY AVIO
- ARGENTO COMETA/SILVER COMET
- OTTONE VENEZIANO/BRASS
- TITANIO/TITANIUM
- BRONZO RIACI/RIACI BRONZE
- VERDE COSTA/GREEN COAST
- TERRA SENESE/SENESE EARTH

DIFFUSORE
DIFFUSER

OPALE/OPAL

	1 cm - 2700K	1 cm - 3000K	1 cm - 4000K
CODICE CODE	103H600001	103H700001	103H800001
	103H601001	103H701001	103H801001
	103H602001	103H702001	103H802001
	103H603001	103H703001	103H803001
	103H604001	103H704001	103H804001
	103H605001	103H705001	103H805001
	103H608001	103H708001	103H808001
	103H609001	103H709001	103H809001
	103H610001	103H710001	103H810001
	103H611301	103H711301	103H811301
	103H612001	103H712001	103H812001
	103H613001	103H713001	103H813001
	103H614001	103H714001	103H814001
	103H615001	103H715001	103H815001
	103H616001	103H716001	103H816001
	103H617001	103H717001	103H817001

N.B./P.N.:
LUNGHEZZA MASSIMA VERSIONE CROMO = 2,00 m / MAXIMUM LENGTH CHROME VERSION = 2.00 m
TESTATE NON INCLUSE / DEAD ENDS NOT INCLUDED

u02

led integrato

integrated led

DATI TECNICI
TECHNICAL DATA



	1 cm	1 cm	1 cm
Nominal LED Flux:	1800 lm/m	1900 lm/m	2000 lm/m
Flux Tot:	1440 lm/m	1520 lm/m	160 lm/m
Output:	150 lm/W	158 lm/W	166 lm/W
CCT:	2700 K	3000 K	4000 K
CRI:	>90	>90	>90
Power Tot:	12.0 W/m	12.0 W/m	12.0 W/m
Weight:	0.50 Kg/m	0.50 Kg/m	0.50 Kg/m

Alluminio/aluminium Cover: Opale/opal

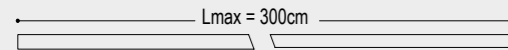

DRIVER NON INCLUSO / NOT INCLUDED

CAVO ALIMENTAZIONE : 50 cm
ALIMENTATION CABLE : 50cm

DIFFUSORE OPALE QUADRATO

FINITURA STRUTTURA FINISHES	DIFFUSORE DIFFUSER	1 cm - 2700K	1 cm - 3000K	1 cm - 4000K
		CODICE CODE	CODICE CODE	CODICE CODE
GRIGIO VESUVIO ANTHRACITE	OPALE/OPAL	1035400201	1035500201	1035600201
ARGILLA CLAY		1035401201	1035501201	1035601201
ARGENTO OPACO/MATT SILVER		1035402201	1035502201	1035602201
BIANCO INTONACO/WHITE		1035403201	1035503201	1035603201
NERO CARAVAGGIO BLACK		1035404201	1035504201	1035604201
MOKA MOCHA		1035405201	1035505201	1035605201
CROMO CHROME		1035408201	1035508201	1035608201
ORO CALIFORNIA/GOLD		1035409201	1035509201	1035609201
ARAMEN COPPER		1035410201	1035510201	1035610201
GRIGIO AVIO/GREY AVIO		1035410301	1035510301	1035610301
ARGENTO COMETA/SILVER COMET		1035412201	1035512201	1035612201
OTTONE VENEZIANO/BRASS		1035413201	1035513201	1035613201
TITANIO/TITANIUM		1035414201	1035514201	1035614201
BRONZO RIACI/RIACI BRONZE		1035415201	1035515201	1035615201
VERDE COSTA/GREEN COAST		1035416201	1035516201	1035616201
TERRA SENESE/SENESE EARTH		1035417201	1035517201	1035617201

N.B./P.N.:
LUNGHEZZA MASSIMA VERSIONE CROMO = 2,00 m / MAXIMUM LENGTH CHROME VERSION = 2.00 m
TESTATE NON INCLUSE / DEAD ENDS NOT INCLUDED

u02

led integrato

integrated led

DATI TECNICI
TECHNICAL DATA



	1 cm	1 cm	1 cm
Nominal LED Flux:	1800 lm/m	1900 lm/m	2000 lm/m
Flux Tot:	1440 lm/m	1520 lm/m	160 lm/m
Output:	150 lm/W	158 lm/W	166 lm/W
CCT:	2700 K	3000 K	4000 K
CRI:	>90	>90	>90
Power Tot:	12.0 W/m	12.0 W/m	12.0 W/m
Weight:	0.50 Kg/m	0.50 Kg/m	0.50 Kg/m

Alluminio/aluminium Cover: Opale/opal

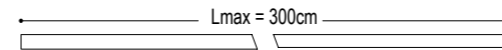

DRIVER NON INCLUSO / NOT INCLUDED

CAVO ALIMENTAZIONE : 50 cm
ALIMENTATION CABLE : 50cm

DIFFUSORE OPALE TONDO

FINITURA STRUTTURA FINISHES	DIFFUSORE DIFFUSER	1 cm - 2700K	1 cm - 3000K	1 cm - 4000K
		CODICE CODE	CODICE CODE	CODICE CODE
GRIGIO VESUVIO ANTHRACITE	OPALE/OPAL	1035400401	1035500401	1035600401
ARGILLA CLAY		1035401401	1035501401	1035601401
ARGENTO OPACO/MATT SILVER		1035402401	1035502401	1035602401
BIANCO INTONACO/WHITE		1035403401	1035503401	1035603401
NERO CARAVAGGIO BLACK		1035404401	1035504401	1035604401
MOKA MOCHA		1035405401	1035505401	1035605401
CROMO CHROME		1035408401	1035508401	1035608401
ORO CALIFORNIA/GOLD		1035409401	1035509401	1035609401
ARAMEN COPPER		1035410401	1035510401	1035610401
GRIGIO AVIO/GREY AVIO		1035410301	1035510301	1035610301
ARGENTO COMETA/SILVER COMET		1035412401	1035512401	1035612401
OTTONE VENEZIANO/BRASS		1035413401	1035513401	1035613401
TITANIO/TITANIUM		1035414401	1035514401	1035614401
BRONZO RIACI/RIACI BRONZE		1035415401	1035515401	1035615401
VERDE COSTA/GREEN COAST		1035416401	1035516401	1035616401
TERRA SENESE/SENESE EARTH		1035417401	1035517401	1035617401

N.B./P.N.:
LUNGHEZZA MASSIMA VERSIONE CROMO = 2,00 m / MAXIMUM LENGTH CHROME VERSION = 2.00 m
TESTATE NON INCLUSE / DEAD ENDS NOT INCLUDED

DATI TECNICI
TECHNICAL DATA

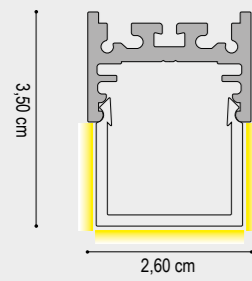

	1 cm	1 cm	1 cm
Nominal LED Flux:	2760 lm/m	2875 lm/m	2990 lm/m
Flux Tot:	2170 lm/m	2380 lm/m	2540 lm/m
Output:	120 lm/W	125 lm/W	130 lm/W
CCT:	2700 K	3000 K	4000 K
CRI:	>90	>90	>90
Power Tot:	23.0 W/m	23.0 W/m	23.0 W/m
Weight:	0.50 Kg/m	0.50 Kg/m	0.50 Kg/m

Alluminio/aluminum
Cover: Opale/opal

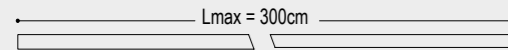

DRIVER NON INCLUSO / NOT INCLUDED

CAVO ALIMENTAZIONE : 50 cm
ALIMENTATION CABLE : 50cm

DIFFUSORE OPALE QUADRATO

FINITURA STRUTTURA
FINISHES

- GRIGIO VESUVIO ANTHRACITE
- ARGILLA CLAY
- ARGENTO OPACO/MATT SILVER
- BIANCO INTONACO/WHITE
- NERO CARAVAGGIO BLACK
- MOKA MOCHA
- CROMO/CHROME
- ORO CALIFORNIA/GOLD
- ARAMEN COPPER
- GRIGIO AVIO/GREY AVIO
- ARGENTO COMETA/SILVER COMET
- OTTONE VENEZIANO/BRASS
- TITANIO/TITANIUM
- BRONZO RIACI/RIACI BRONZE
- VERDE COSTA/GREEN COAST
- TERRA SENESE SENESE EARTH

DIFFUSORE
DIFFUSER

OPALE/OPAL

	1 cm - 2700K	1 cm - 3000K	1 cm - 4000K
CODICE CODE	103H600201	103H700201	103H800201
	103H601201	103H701201	103H801201
	103H602201	103H702201	103H802201
	103H603201	103H703201	103H803201
	103H604201	103H704201	103H804201
	103H605201	103H705201	103H805201
	103H608201	103H708201	103H808201
	103H609201	103H709201	103H809201
	103H610201	103H710201	103H810201
	103H611401	103H711401	103H811401
	103H612201	103H712201	103H812201
	103H613201	103H713201	103H813201
	103H614201	103H714201	103H814201
	103H615201	103H715201	103H815201
	103H616201	103H716201	103H816201
	103H617201	103H717201	103H817201

N.B./P.N.:
LUNGHEZZA MASSIMA VERSIONE CROMO = 2,00 m / MAXIMUM LENGTH CHROME VERSION = 2.00 m
TESTATE NON INCLUDE / DEAD ENDS NOT INCLUDED

DATI TECNICI
TECHNICAL DATA

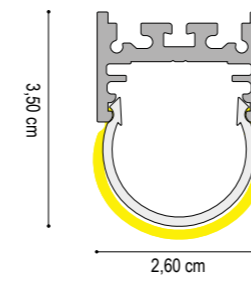

	1 cm	1 cm	1 cm
Nominal LED Flux:	2760 lm/m	2875 lm/m	2990 lm/m
Flux Tot:	2170 lm/m	2380 lm/m	2540 lm/m
Output:	120 lm/W	125 lm/W	130 lm/W
CCT:	2700 K	3000 K	4000 K
CRI:	>90	>90	>90
Power Tot:	23.0 W/m	23.0 W/m	23.0 W/m
Weight:	0.50 Kg/m	0.50 Kg/m	0.50 Kg/m

Alluminio/aluminum
Cover: Opale/opal

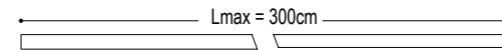

DRIVER NON INCLUSO / NOT INCLUDED

CAVO ALIMENTAZIONE : 50 cm
ALIMENTATION CABLE : 50cm

DIFFUSORE OPALE TONDO

FINITURA STRUTTURA
FINISHES

- GRIGIO VESUVIO ANTHRACITE
- ARGILLA CLAY
- ARGENTO OPACO/MATT SILVER
- BIANCO INTONACO/WHITE
- NERO CARAVAGGIO BLACK
- MOKA MOCHA
- CROMO/CHROME
- ORO CALIFORNIA/GOLD
- ARAMEN COPPER
- GRIGIO AVIO/GREY AVIO
- ARGENTO COMETA/SILVER COMET
- OTTONE VENEZIANO/BRASS
- TITANIO/TITANIUM
- BRONZO RIACI/RIACI BRONZE
- VERDE COSTA/GREEN COAST
- TERRA SENESE SENESE EARTH

DIFFUSORE
DIFFUSER

OPALE/OPAL

	1 cm - 2700K	1 cm - 3000K	1 cm - 4000K
CODICE CODE	103H600401	103H700401	103H800401
	103H601401	103H701401	103H801401
	103H602401	103H702401	103H802401
	103H603401	103H703401	103H803401
	103H604401	103H704401	103H804401
	103H605401	103H705401	103H805401
	103H608401	103H708401	103H808401
	103H609401	103H709401	103H809401
	103H610401	103H710401	103H810401
	103H611401	103H711401	103H811401
	103H612401	103H712401	103H812401
	103H613401	103H713401	103H813401
	103H614401	103H714401	103H814401
	103H615401	103H715401	103H815401
	103H616401	103H716401	103H816401
	103H617401	103H717401	103H817401

N.B./P.N.:
LUNGHEZZA MASSIMA VERSIONE CROMO = 2,00 m / MAXIMUM LENGTH CHROME VERSION = 2.00 m
TESTATE NON INCLUDE / DEAD ENDS NOT INCLUDED

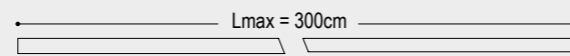
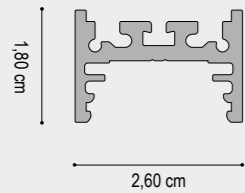

FINITURA STRUTTURA FINISHES

- GRIGIO VESUVIO/ANTHRACITE
- ARGILLA/ARGIL
- ARGENTO OPACO/MATT SILVER
- BIANCO INTONACO/WHITE
- NERO CARAVAGGIO/BLACK
- MOKA/MOCHA
- ALLUMINIO NATURALE/ALUMINUM
- ORO CALIFORNIA/GOLD
- ARAMEN/COPPER
- GRIGIO AVIO/GREY AVIO
- ARGENTO COMETA/SILVER COMET
- OTTONE VENEZIANO/BRASS
- TITANIO/TITANIUM
- BRONZO RIACI/RIACI BRONZE
- VERDE COSTA/GREEN COAST
- TERRA SENESE/SENESE EARTH
- CROMO/CHROME

	1 cm	200 cm	300 cm
CODICE CODE	CODICE CODE	CODICE CODE	CODICE CODE
1030300001	1030300200	1030300300	
1030301001	1030301200	1030301300	
1030302001	1030302200	1030302300	
1030303001	1030303200	1030303300	
1030304001	1030304200	1030304300	
1030305001	1030305200	1030305300	
1030306001	1030306200	1030306300	
1030309001	1030309200	1030309300	
1030310001	1030310200	1030310300	
1030311001	1030311200	1030311300	
1030312001	1030312200	1030312300	
1030313001	1030313200	1030313300	
1030314001	1030314200	1030314300	
1030315001	1030315200	1030315300	
1030316001	1030316200	1030316300	
1030317001	1030317200	1030317300	
1030308001	1030308200		

ATTENZIONE/PLEASE NOTE: LUNGHEZZA MASSIMA VERSIONE CROMO = 2,00 m / MAXIMUM LENGTH CHROME VERSION = 2.00 m
TESTATE DI CHIUSURA NON INCLUSE / DEAD ENDS NOT INCLUDED

LED compatibili / LED compatibility

HIGH QUALITY CRI>90 CRI>95	HIGH OUTPUT CRI>90 CRI>95	HIGH EFFICIENT CRI>90 CRI>95	HIGH INTENSITY CRI>90 CRI>95	LOW POWER CRI>90	ULTRA SLIM CRI>90 CRI>95 CRI>97	RGB	RGB WHITE	RGB TW	TUNABLE WHITE
9,6W 14,4W 19,2W	12,3W 14,4W 19,2W 20W 24W	11,0W 12,3W 14,4W 19,2W 20W 24W	24W 24W (700 LED)	6W	7,0W 9,6W 12W 14,4W	14W	14W	14,4W 23W	19,2W



DIFFUSORE

		1 cm	200 cm	300 cm	300 cm
	DIFFUSORE DIFFUSER	CODICE CODE	CODICE CODE	CODICE CODE	CODICE CODE
	OPALE/OPAL	1030100001	1030100200	1030100300	1030100400
	SATINATA/SATIN	1030101001	1030101200	1030101300	1030101400
	PRISMATIZZATO/PRISMATIC	1030113001	1030113200	1030113300	
	OPALE/OPAL	1030110001	1030110200	1030110300	
	SATINATA/SATIN	1030111001	1030111200	1030111300	
	OPALE/OPAL	1030120001	1030120200	1030120300	
	SATINATA/SATIN	1030121001	1030121200	1030121300	
	OPALE/OPAL	1030105001	1030105200	1030105300	
	SATINATA/SATIN	1030115001	1030115200	1030115300	

LENTE 65°

		1 cm	200 cm
	DIFFUSORE DIFFUSER	CODICE CODE	CODICE CODE
	LENTE 65°/LENS 65°	1030201001	1030201200

COVER ALLUMINIO / ALUMINUM COVER

	1 cm	1 cm
FINITURA STRUTTURA FINISHES	CODICE CODE	FINITURA STRUTTURA FINISHES
GRIGIO VESUVIO ANTHRACITE	103CM00001	ARAMEN COPPER
ARGILLA CLAY	103CM01001	GRIGIO AVIO GREY AVIO
ARGENTO OPACO MATT SILVER	103CM02001	ARGENTO COMETA SILVER COMET
BIANCO INTONACO WHITE	103CM03001	OTTONE VENEZIANO BRASS
NERO CARAVAGGIO BLACK	103CM04001	TITANIO TITANIUM
MOKA MOCHA	103CM05001	BRONZO RIACI RIACI BRONZE
CROMO CHROME	103CM08001	VERDE COSTA GREEN COAST
ORO CALIFORNIA GOLD	103CM09001	TERRA SENESE SENESE EARTH

LED compatibili / LED compatibility NEW

48V ONE CHIP CUT CRI>90 CRI>95	TWO CHIPS CUT CRI>90 CRI>95	SLIM ONE CHIP CUT CRI>90 CRI>95
8,0W 12,0W 19,2W	14,4W 24,0W	7,0W 9,0W 19,2W



TESTATE DI CHIUSURA / DEAD ENDS

FINITURA STRUTTURA FINISHES	CODICE CODE	FINITURA STRUTTURA FINISHES	CODICE CODE
GRIGIO VESUVIO/ANTHRACITE	1030400000	ARAMEN/COPPER	1030410000
ARGILLA/ARGIL	1030401000	GRIGIO AVIO/GREY AVIO	1030411000
ARGENTO OPACO/MATT SILVER	1030402000	ARGENTO COMETA/SILVER COMET	1030412000
BIANCO INTONACO/WHITE	1030403000	OTTONE VENEZIANO/BRASS	1030413000
NERO CARAVAGGIO/BLACK	1030404000	TITANIO/TITANIUM	1030414000
MOKA/MOCHA	1030405000	BRONZO RIACI/RIACI BRONZE	1030415000
ALLUMINIO NATURALE/ALUMINUM	1030406000	VERDE COSTA/GREEN COAST	1030416000
CROMO/CHROME	1030408000	TERRA SENESE/SENESE EARTH	1030417000
ORO CALIFORNIA/GOLD	1030409000		

Il codice contiene 1 testata di chiusura con viti.
The code contains 1 closing warhead with screws.

TESTATE DI CHIUSURA QUADRATA / SQUARE DEAD ENDS

FINITURA STRUTTURA FINISHES	CODICE CODE	FINITURA STRUTTURA FINISHES	CODICE CODE
GRIGIO VESUVIO/ANTHRACITE	1030500000	ARAMEN/COPPER	1030510000
ARGILLA/ARGIL	1030501000	GRIGIO AVIO/GREY AVIO	1030511000
ARGENTO OPACO/MATT SILVER	1030502000	ARGENTO COMETA/SILVER COMET	1030512000
BIANCO INTONACO/WHITE	1030503000	OTTONE VENEZIANO/BRASS	1030513000
NERO CARAVAGGIO/BLACK	1030504000	TITANIO/TITANIUM	1030514000
MOKA/MOCHA	1030505000	BRONZO RIACI/RIACI BRONZE	1030515000
ALLUMINIO NATURALE/ALUMINUM	1030506000	VERDE COSTA/GREEN COAST	1030516000
CROMO/CHROME	1030508000	TERRA SENESE/SENESE EARTH	1030517000
ORO CALIFORNIA/GOLD	1030509000		

Il codice contiene 1 testata di chiusura con viti.
The code contains 1 closing warhead with screws.

TESTATE DI CHIUSURA QUADRATA / SQUARE DEAD ENDS

FINITURA STRUTTURA FINISHES	CODICE CODE	FINITURA STRUTTURA FINISHES	CODICE CODE
GRIGIO VESUVIO/ANTHRACITE	1030700000	ARAMEN/COPPER	1030710000
ARGILLA/ARGIL	1030701000	GRIGIO AVIO/GREY AVIO	1030711000
ARGENTO OPACO/MATT SILVER	1030702000	ARGENTO COMETA/SILVER COMET	1030712000
BIANCO INTONACO/WHITE	1030703000	OTTONE VENEZIANO/BRASS	1030713000
NERO CARAVAGGIO/BLACK	1030704000	TITANIO/TITANIUM	1030714000
MOKA/MOCHA	1030705000	BRONZO RIACI/RIACI BRONZE	1030715000
ALLUMINIO NATURALE/ALUMINUM	1030706000	VERDE COSTA/GREEN COAST	1030716000
CROMO/CHROME	1030708000	TERRA SENESE/SENESE EARTH	1030717000
ORO CALIFORNIA/GOLD	1030709000		

Il codice contiene 1 testata di chiusura con viti.
The code contains 1 closing warhead with screws.

TESTATE DI CHIUSURA TONDE / SQUARE DEAD ENDS

FINITURA STRUTTURA FINISHES	CODICE CODE	FINITURA STRUTTURA FINISHES	CODICE CODE
GRIGIO VESUVIO/ANTHRACITE	1030600000	ARAMEN/COPPER	1030610000
ARGILLA/ARGIL	1030601000	GRIGIO AVIO/GREY AVIO	1030611000
ARGENTO OPACO/MATT SILVER	1030602000	ARGENTO COMETA/SILVER COMET	1030612000
BIANCO INTONACO/WHITE	1030603000	OTTONE VENEZIANO/BRASS	1030613000
NERO CARAVAGGIO/BLACK	1030604000	TITANIO/TITANIUM	1030614000
MOKA/MOCHA	1030605000	BRONZO RIACI/RIACI BRONZE	1030615000
ALLUMINIO NATURALE/ALUMINUM	1030606000	VERDE COSTA/GREEN COAST	1030616000
CROMO/CHROME	1030608000	TERRA SENESE/SENESE EARTH	1030617000
ORO CALIFORNIA/GOLD	1030609000		

Il codice contiene 1 testata di chiusura con viti.
The code contains 1 closing warhead with screws.

TESTATE DI CHIUSURA TONDE / SQUARE DEAD ENDS

FINITURA STRUTTURA FINISHES	CODICE CODE	FINITURA STRUTTURA FINISHES	CODICE CODE
GRIGIO VESUVIO/ANTHRACITE	1030800000	ARAMEN/COPPER	1030810000
ARGILLA/ARGIL	1030801000	GRIGIO AVIO/GREY AVIO	1030811000
ARGENTO OPACO/MATT SILVER	1030802000	ARGENTO COMETA/SILVER COMET	1030812000
BIANCO INTONACO/WHITE	1030803000	OTTONE VENEZIANO/BRASS	1030813000
NERO CARAVAGGIO/BLACK	1030804000	TITANIO/TITANIUM	1030814000
MOKA/MOCHA	1030805000	BRONZO RIACI/RIACI BRONZE	1030815000
ALLUMINIO NATURALE/ALUMINUM	1030806000	VERDE COSTA/GREEN COAST	1030816000
CROMO/CHROME	1030808000	TERRA SENESE/SENESE EARTH	1030817000
ORO CALIFORNIA/GOLD	1030809000		

Il codice contiene 1 testata di chiusura con viti.
The code contains 1 closing warhead with screws.

VERSIONE KIT / KIT VERSION

DATI TECNICI TECHNICAL DATA	FINITURA FINISHES	DIFFUSORE DIFFUSER	200 cm		300 cm	
			CODICE CODE		CODICE CODE	
ARTICOLI INCLUSI NEL CODICE ARTICLES INCLUDED IN THE CODE	ALLUMINIO NATURALE/ALUMINUM	OPALE/OPAL	103P22		103P23	
	NERO CARAVAGGIO/BLACK		103P42		103P43	
N°2 testate di chiusura / No. 2 closing heads N°3 staffe di fissaggio per superfici irregolari 3mm No. 3 fixing brackets for uneven surfaces 3mm	ALLUMINIO NATURALE/ALUMINUM	SATINATA/SATIN	103S22		103S22	
	BIANCO INTONACO/WHITE		103S32		103S33	
	NERO CARAVAGGIO/BLACK		103S42		103S43	

STAFFA DI FISSAGGIO A DOPPIO ATTACCO / DOUBLE MOUNTING CLIP

FINITURA FINISHES	CODICE CODE
SUPERFICI PIANE 2mm EVEN SURFACE 2mm	1020500005
SUPERFICI IRREGOLARI 3,9mm UNEVEN SURFACE 3,9mm	1020500006



Accessorio per fissaggio a plafone/superficie. Quantità raccomandata: 1 pz ogni 50 cm di modello.

Ceiling/surface mounting accessory. Recommended quantity 1 pc every 50 cm of model.

CALAMITA / MAGNET

CODICE CODE	PORTATA RANGE
1020500010	1 Kg
1020500210	2 Kg



Quantità raccomandata: 1 pz ogni 25 cm di modello
Recommended quantity: 1 pc every 25 cm of model

KIT DI SOSPENSIONE / SUSPENSION KIT

ARTICOLI INCLUSI NEL CODICE
ARTICLES INCLUDED IN THE CODE

Cavo in acciaio 2,00m con puntalino
2.00m steel cable with tip
Boccola cromata con regolazione millimetrica
Chrome bush with millimeter adjustment
Archetto in alluminio per sospensione
Aluminum arch for suspension

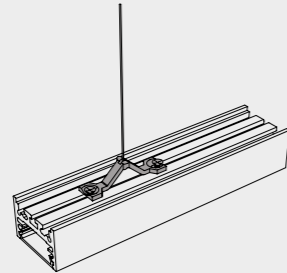

FINITURA STRUTTURA FINISHES	CODICE CODE
GRIGIO VESUVIO/ANTHRACITE	1040500004
ARGILLA/ARGIL	1040501004
ARGENTO OPACO/MATT SILVER	1040502004
BIANCO INTONACO/WHITE	1040503004
NERO CARAVAGGIO/BLACK	1040504004
MOKA/MOCHA	1040505004
CROMO/CHROME	1040508004
ORO CALIFORNIA/GOLD	1040509004
ARAMEN/COPPER	1040510004
ARGENTO COMETA/SILVER COMET	1030712004
OTTONE VENEZIANO/BRASS	1030713004
TITANIO/TITANIUM	1090714004
BRONZO RIACI/RIACI BRONZE	1090715004
VERDE COSTA/GREEN COAST	1090716004
TERRA SENESE/SENESE EARTH	1040517004

STAFFA A PARETE REGOLABILE / ADJUSTABLE WALL BRACKET

DATI TECNICI
TECHNICAL DATA

MATERIALE: Alluminio naturale
MATERIAL: Natural aluminum

ARTICOLI INCLUSI NEL CODICE
ARTICLES INCLUDED IN THE CODE

N°1 staffa regolabile in alluminio
N°1 adjustable aluminium bracket
Viti per il fissaggio
Screw to fix

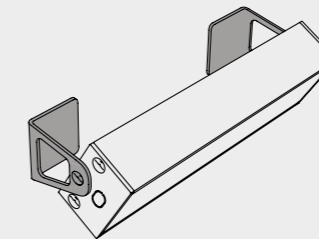

FINITURA STRUTTURA
FINISHES

GRIGIO VESUVIO/ANTHRACITE	1030500005
ARGILLA/ARGIL	1030501005
ARGENTO OPACO/MATT SILVER	1030502005
BIANCO INTONACO/WHITE	1030503005
NERO CARAVAGGIO/BLACK	1030504005
MOKA/MOCHA	1030505005
CROMO/CHROME	1030508005
ORO CALIFORNIA/GOLD	1030509005
ARAMEN/COPPER	1030510005
GRIGIO AVIO/GREY AVIO	1030511005
ARGENTO COMETA/SILVER COMET	1030512005
OTTONE VENEZIANO/BRASS	1030513005
TITANIO/TITANIUM	1030514005
BRONZO RIACI/RIACI BRONZE	1030515005
VERDE COSTA/GREEN COAST	1030516005
TERRA SENESE/SENESE EARTH	1030517005

STAFFA DI FISSAGGIO A PARETE / WALL MOUNTING CLIP

DATI TECNICI
TECHNICAL DATA

MATERIALE: Alluminio naturale
MATERIAL: Natural aluminum

Il codice comprende n°2 staffe con asole.
The code includes n°2 wall brackets whit holes.

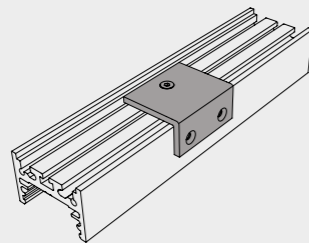

FINITURA STRUTTURA FINISHES	CODICE CODE
GRIGIO VESUVIO/ANTHRACITE	1030500003
ARGILLA/ARGIL	1030501003
ARGENTO OPACO/MATT SILVER	1030502003
BIANCO INTONACO/WHITE	1030503003
NERO CARAVAGGIO/BLACK	1030504003
MOKA/MOCHA	1030505003
CROMO/CHROME	1030508003
ORO CALIFORNIA/GOLD	1030509003
ARAMEN/COPPER	1030510003
GRIGIO AVIO/GREY AVIO	1030511003
ARGENTO COMETA/SILVER COMET	1030512003
OTTONE VENEZIANO/BRASS	1030513003
TITANIO/TITANIUM	1030514003
BRONZO RIACI/RIACI BRONZE	1030515003
VERDE COSTA/GREEN COAST	1030516003
TERRA SENESE/SENESE EARTH	1030517003

STAFFA INCASSO CARTONGESSO / PLASTERBOARD RECESSED BRACKET

DATI TECNICI
TECHNICAL DATA

Accessorio che consente l'incasso del modello.
Accessory that allows the collection of the model.

Nel codice sono comprese le viti per il fissaggio del modello alla staffa. The code includes screws for fixing ther model to the bracket.

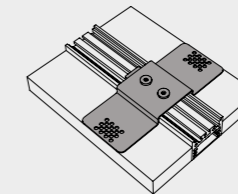

FINITURA STRUTTURA
FINISHES

ALLUMINIO NATURALE/ALUMINUM	1030500002
-----------------------------	------------

GIUNTI / JOINTS

GIUNTO LINEA CONTINUA / STRAIGHT JOINT
Accessorio per giunzioni meccaniche lineari
Accessory for linear mechanical joints

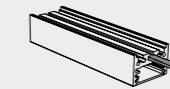

FINITURA
FINISHES

ALLUMINIO NATURALE/ALUMINUM	1010500006
-----------------------------	------------

GIUNTO 90° ORIZZONTALE / HORIZONTAL JOINT 90°
Accessorio per giunzioni meccaniche con angolo 90°
Accessory for linear mechanical joints with 90° angle

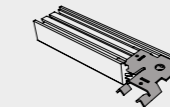

ALLUMINIO NATURALE/ALUMINUM	1030500006
-----------------------------	------------

GIUNTO 90° VERTICALE / VERTICAL JOINT 90°
Accessorio per giunzioni meccaniche con angolo 90°
Accessory for linear mechanical joints with 90° angle

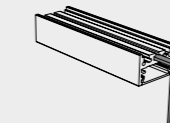

ALLUMINIO NATURALE/ALUMINUM	1010500007
-----------------------------	------------

Il codice contiene i grani per il fissaggio del giunto.
The code contains the grains to fix the joint.

DATI TECNICI
TECHNICAL DATA

	35 cm	70 cm	105 cm	120 cm
Nominal SPOT Flux:	2178 lm	3267 lm	4356 lm	5445 lm
Flux Tot:	1742 lm	2614 lm	3485 lm	4356 lm
Output:	121 lm/W	121 lm/W	121 lm/W	121 lm/W
CCT:	3000 K	3000 K	3000 K	3000 K
CRI:	>90	>90	>90	>90
SPOT Power Tot:	18.0W (3W x 6)	27.0W (3W x 9)	36.0W (3W x 12)	45.0W (3W x 15)
Weight:	0.60 Kg	1.20 Kg	1.80 Kg	2.10 Kg

Alluminio/aluminium

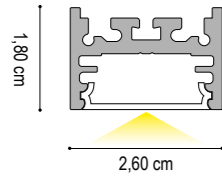

ARTICOLI INCLUSI NEL CODICE:
ITEMS INCLUDED IN THE CODE:

ALIMENTATORE ON/OFF REMOTO / REMOTE POWER SUPPLY ON/OFF
COPPIA DI TESTATE DI CHIUSURA / PAIR OF CLOSING HEADS

	35 cm	70 cm	105 cm	120 cm
FINITURA STRUTTURA FINISHES	CODICE CODE	CODICE CODE	CODICE CODE	CODICE CODE
GRIGIO VESUVIO/ANTHRACITE	1038400035	1038400070	1038400105	1038400120
ARGILLA/ARGIL	1038401035	1038401070	1038401105	1038401120
ARGENTO OPACO/MATT SILVER	1038402035	1038402070	1038402105	1038402120
BIANCO INTONACO/WHITE	1038403035	1038403070	1038403105	1038403120
NERO CARAVAGGIO/BLACK	1038404035	1038404070	1038404105	1038404120
MOKA/MOCHA	1038405035	1038405070	1038405105	1038405120
CROMO/CHROME	1038408035	1038408070	1038408105	1038408120
ORO CALIFORNIA/GOLD	1038409035	1038409070	1038409105	1038409120
ARAMENI/COPPER	1038410035	1038410070	1038410105	1038410120
GRIGIO AVIO/GREY AVIO	1038411035	1038411070	1038411105	1038411120
ARGENTO COMETA/SILVER COMET	1038412035	1038412070	1038412105	1038412120
OTTONE VENEZIANO/BRASS	1038413035	1038413070	1038413105	1038413120
TITANIO/TITANIUM	1038414035	1038414070	1038414105	1038414120
BRONZO RIACI/RIACI BRONZE	1038415035	1038415070	1038415105	1038415120
VERDE COSTA/GREEN COAST	1038416035	1038416070	1038416105	1038416120
TERRA SENESE/SENESE EARTH	1038417035	1038417070	1038417105	1038417120

ATTENZIONE/PLEASE NOTE:

LUNGHEZZA MASSIMA VERSIONE CROMO = 2,00 m / MAXIMUM LENGTH CHROME VERSION = 2.00 m

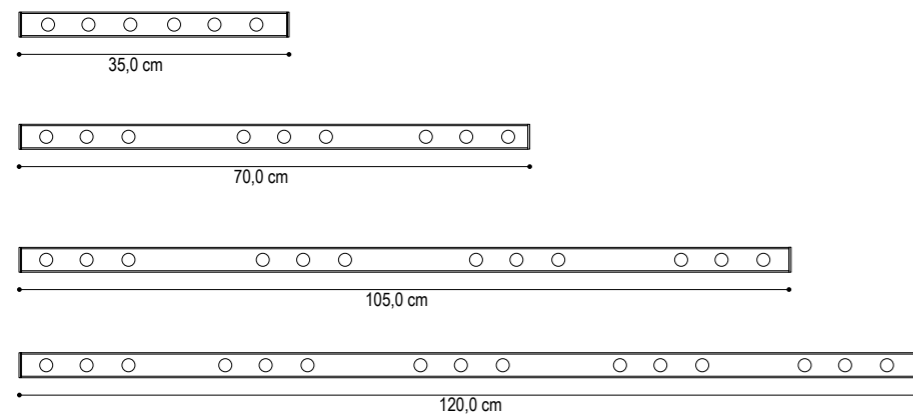

INTERRUTTORE DIMMERABILE / DIMMABLE SWITCH

u02 + u02 point

DATI TECNICI
TECHNICAL DATA

FINITURA STRUTTURA
FINISHES

CODICE
CODE

Accessorio che consente l'accensione e lo spegnimento dei LED e, a seconda della pressione, la regolazione dell'intensità luminosa.
Accessory that allows the switching on and off of the LEDs and, depending on the pressure, the regulation of the light intensity.



ALLUMINIO NATURALE/ALUMINUM

98243

Tensione di alimentazione: 12-24V DC
Supply voltage: 12-24V DC
Corrente d'uscita: 4A max
Output current: 4A max
ON / OFF: contact < 0.7 s
DIMMER: contact > 0.7 s

INTERRUTTORE DIMMERABILE+INSTALLAZIONE / DIMMABLE SWITCH+INSTALLATION

u02 + u02 point

DATI TECNICI
TECHNICAL DATA

FINITURA STRUTTURA
FINISHES

CODICE
CODE

Accessorio che consente l'accensione e lo spegnimento dei LED e, a seconda della pressione, la regolazione dell'intensità luminosa.
Accessory that allows the switching on and off of the LEDs and, depending on the pressure, the regulation of the light intensity.

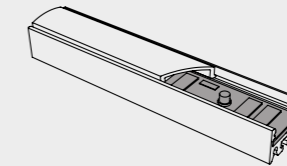

ALLUMINIO NATURALE/ALUMINUM

98244

Tensione di alimentazione: 12-24V DC
Supply voltage: 12-24V DC
Corrente d'uscita: 4A max
Output current: 4A max
ON / OFF: contact < 0.7 s
DIMMER: contact > 0.7 s

LAVORAZIONI / PROCESSING

DATI TECNICI
TECHNICAL DATA

CODICE
CODE

TAGLIO 90° ORIZZONTALE (PER ANGOLI FORMATI DA DUE PROFILI)
HORIZONTAL 90 ° CUT (FOR CORNERS MADE OF TWO PROFILES)

190X



TAGLIO 90° VERTICALE (PER ANGOLI FORMATI DA DUE PROFILI)
VERTICAL 90 ° CUT (FOR CORNERS MADE OF TWO PROFILES)

190Y



TAGLIO ANGOLARE CUSTOM (PER ANGOLI FORMATI DA DUE PROFILI)
CUSTOM CORNER CUT (FOR CORNERS MADE OF TWO PROFILES)

190N



ASOLA / SLOT

100A

ASOLA CUSTOM / SLOT CUSTOM

100N

FORO / HOLE

100F



CABLAGGIO - COLLAUDO - CE AL CENTIMETRO
INSTALLATION AND TESTING LED MODULE AT CENTIMETER

1031

CABLAGGIO - COLLAUDO CE - MONTAGGIO LED IP AL CENTIMETRO
INSTALLATION - TESTING LED CE - ASSEMBLY LED IP AT CENTIMETER

1016



CONNETTORE MASCHIO/FEMMINA
MALE/FEMALE CONNECTOR

98CFM

CONNETTORE MASCHIO/FEMMINA MONTATO NEL PRODOTTO
MALE/FEMALE CONNECTOR FITTED IN THE PRODUCT

98MFM



CAVO DI ALIMENTAZIONE 2X0,75 TONDO TRASPARENTE 1CM POWER
CABLE 2X0,75 ROUND TRANSPARENT 1CM

98CTT001

CAVO DI ALIMENTAZIONE 2X0,75 STAGNO 1CM
POWER CABLE 2X0,75 STAGNO 1CM

98CS001

“massima espressione tecnologica”

U03, le dimensioni non contano...Non sempre piccolo è sinonimo di inefficienza; nel nostro profilo U03 è racchiusa la massima espressione tecnologica dell'estrusione dell'alluminio finalizzata alla dissipazione termica. Luce morbida e diffusa grazie alla cover dedicata in policarbonato. Linee pulite ed essenziali.

U03, dimensions doesn't matter...Small is not always synonym for inefficiency, in our U03 profile is contained the highest expression of technology aimed at the aluminum extrusion heat dissipation. Soft and diff used light thanks to dedicated polycarbonate cover. Clean and essential lines.





ATTENZIONE! GLI ACCESSORI PER L'INSTALLAZIONE A INCASSO SONO STATI DIMENSIONATI PER UN PANNELLO STANDARD IN CARTONGESSO DI SPESSORE 12,5 mm
WARNING! THE BUILT-IN INSTALLATION ACCESSORIES HAVE BEEN DIMENSIONED FOR A STANDARD PLASTERBOARD PANEL OF 12.5 mm THICKNESS

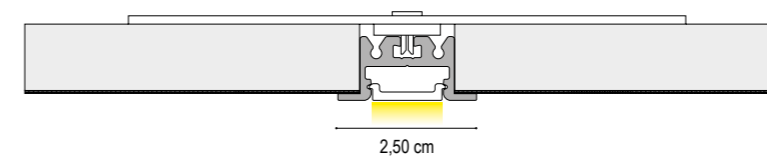

INSTALLAZIONE CON STAFFA PER INCASSO A CARTONGESSO
INSTALLATION WITH BUILT-IN BRACKET

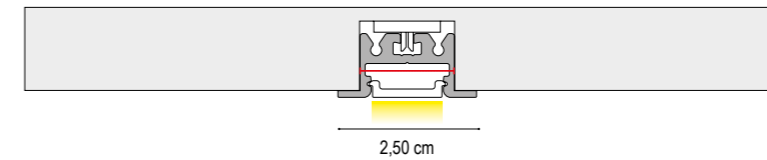

INSTALLAZIONE AD INCASSO CON CLIP IN POLICARBONATO IN MENSOLA
BUILT-IN INSTALLATION WITH SHELF IN POLYCARBONATE

INSTALLAZIONE AD INCASSO
LARGHEZZA TAGLIO L=1,70cm
RECESSED INSTALLATION
CUTTING WIDTH L=1,70cm



1. SOFFITTO/PARETE - ANGOLO 90° VERTICALE
1. CEILING/WALL VERTICAL 90 ° CORNER

ACCESSORI E LAVORAZIONI
ACCESSORIES AND PROCESSING

GIUNTO MECCANICO / MECHANICAL JOINT
CODICE / CODE: 1010500007

STAFFA A INCASSO / RECESSED BRACKET
CODICE / CODE: 1090500001

TAGLIO ANGOLARE / CORNER CUT
CODICE / CODE: 190Y



2. SOFFITTO - ANGOLO 90° ORIZZONTALE
2. CEILING - HORIZONTAL 90 ° CORNER

ACCESSORI E LAVORAZIONI
ACCESSORIES AND PROCESSING

GIUNTO MECCANICO / MECHANICAL JOINT
CODICE / CODE: 1010500005

STAFFA A INCASSO / RECESSED BRACKET
CODICE / CODE: 1090500001

TAGLIO ANGOLARE / CORNER CUT
CODICE / CODE: 190X



3. PARETE - ANGOLO 90° VERTICALE
3. WALL - VERTICAL 90 ° CORNER

ACCESSORI E LAVORAZIONI
ACCESSORIES AND PROCESSING

GIUNTO MECCANICO / MECHANICAL JOINT
CODICE / CODE: 1010500007

STAFFA A INCASSO / RECESSED BRACKET
CODICE / CODE: 1090500001

TAGLIO ANGOLARE / CORNER CUT
CODICE / CODE: 190Y

DATI TECNICI
TECHNICAL DATA

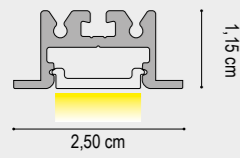

	1 cm	1 cm	1 cm
Nominal LED Flux:	1510 lm/m	1590 lm/m	1760 lm/m
Flux Tot:	1210 lm/m	1272 lm/m	1410 lm/m
Output:	110 lm/W	110 lm/W	110 lm/W
CCT:	2700 K	3000 K	4000 K
CRI:	>95	>95	>95
Power Tot:	14.4 W/m	14.4 W/m	14.4 W/m
Weight:	0.40 Kg/m	0.40 Kg/m	0.40 Kg/m

Alluminio/aluminum
Cover: Opale/opal

Lmax = 300cm

DRIVER NON INCLUSO / NOT INCLUDED

CAVO ALIMENTAZIONE : 50 cm
ALIMENTATION CABLE : 50 cm

FINITURA STRUTTURA FINISHES	DIFFUSORE DIFFUSER	1 cm - 2700K	1 cm - 3000K	1 cm - 4000K
		CODICE CODE	CODICE CODE	CODICE CODE
GRIGIO VESUVIO ANTHRACITE	OPALE/OPAL	114G100001	114G201001	114G301001
ARGILLA CLAY		114G101001	114G201001	114G301001
ARGENTO OPACO/MATT SILVER		114G102001	114G202001	114G302001
BIANCO INTONACO/WHITE		114G103001	114G203001	114G303001
NERO CARAVAGGIO BLACK		114G104001	114G204001	114G304001
MOKA MOCHA		114G114001	114G205001	114G305001
CROMO/CHROME		114G108001	114G208001	114G208001
ORO CALIFORNIA/GOLD		114G109001	114G209001	114G309001
ARAMEN COPPER		114G110001	114G210001	114G310001
ARGENTO COMETA/SILVER COMET		114G112001	114G212001	114G312001
OTTONE VENEZIANO BRASS		114G113001	114G213001	114G313001
TITANIO/TITANIUM		114G114001	114G214001	114G314001
BRONZO RIACI/RIACI BRONZE		114G115001	114G215001	114G315001
VERDE COSTA/GREEN COAST		114G116001	114G215001	114G316001
TERRA SENESE SENESE EARTH	114G117001	114G217001	114G317001	

N.B./P.N.: LUNGHEZZA MASSIMA VERSIONE CROMO = 2,00 m / MAXIMUM LENGTH CHROME VERSION = 2.00 m
TESTATE DI CHIUSURA NON INCLUSE / DEAD ENDS NOT INCLUDED

DATI TECNICI
TECHNICAL DATA

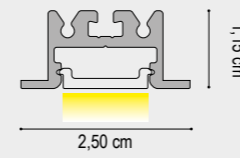

	1 cm	1 cm	1 cm
Nominal LED Flux:	1530 lm/m	1610 lm/m	1790 lm/m
Flux Tot:	1220 lm/m	1290 lm/m	1430 lm/m
Output:	135 lm/W	135 lm/W	135 lm/W
CCT:	2700 K	3000 K	4000 K
CRI:	>97 - R9>90	>97 - R9>90	>97 - R9>90
Power Tot:	12 W/m	12 W/m	12 W/m
Weight:	0.40 Kg/m	0.40 Kg/m	0.40 Kg/m

Alluminio/aluminum
Cover: Opale/opal

Lmax = 300cm

DRIVER NON INCLUSO / NOT INCLUDED

CAVO ALIMENTAZIONE : 50 cm
ALIMENTATION CABLE : 50 cm

FINITURA STRUTTURA FINISHES	DIFFUSORE DIFFUSER	1 cm - 2700K	1 cm - 3000K	1 cm - 4000K
		CODICE CODE	CODICE CODE	CODICE CODE
GRIGIO VESUVIO ANTHRACITE	OPALE/OPAL	1149600001	1149700001	1149800001
ARGILLA CLAY		1149601001	1149701001	1149801001
ARGENTO OPACO/MATT SILVER		1149602001	1149702001	1149802001
BIANCO INTONACO/WHITE		1149603001	1149703001	1149803001
NERO CARAVAGGIO BLACK		1149604001	1149704001	1149804001
MOKA MOCHA		1149605001	1149705001	1149805001
CROMO/CHROME		1149608001	1149708001	1149808001
ORO CALIFORNIA/GOLD		1149609001	1149709001	1149809001
ARAMEN COPPER		1149610001	1149710001	1149810001
ARGENTO COMETA/SILVER COMET		1149612001	1149712001	1149812001
OTTONE VENEZIANO BRASS		1149613001	1149713001	1149813001
TITANIO/TITANIUM		1149614001	1149714001	1149814001
BRONZO RIACI/RIACI BRONZE		1149615001	1149715001	1149815001
VERDE COSTA/GREEN COAST		1149616001	1149716001	1149816001
TERRA SENESE SENESE EARTH	1149617001	1149717001	1149817001	

N.B./P.N.: LUNGHEZZA MASSIMA VERSIONE CROMO = 2,00 m / MAXIMUM LENGTH CHROME VERSION = 2.00 m
TESTATE DI CHIUSURA NON INCLUSE / DEAD ENDS NOT INCLUDED



LED compatibili / LED compatibility

HIGH QUALITY CRI>90 CRI>95	HIGH OUTPUT CRI>90 CRI>95	HIGH EFFICIENT CRI>90 CRI>95	HIGH INTENSITY CRI>90 CRI>95	LOW POWER CRI>90	ULTRA SLIM CRI>90 CRI>95 CRI>97	RGB	RGB WHITE	RGB TW	TUNABLE WHITE
9,6W 14,4W 19,2W	12,3W 14,4W 19,2W 20W 24W	11,0W 12,3W 14,4W 19,2W 20W 24W	24W 24W (700 LED)	6W	7,0W 9,6W 12W 14,4W	14W	14W	14,4W 23W	19,2W

LED compatibili / LED compatibility **NEW**

48V ONE CHIP CUT CRI>90 CRI>95	TWO CHIPS CUT CRI>90 CRI>95	SLIM ONE CHIP CUT CRI>90 CRI>95
8,0W 12,0W 19,2W	14,4W 24,0W	7,0W 9,0W 19,2W

FINITURA STRUTTURA FINISHES	1 cm			200 cm			300 cm		
	CODICE CODE			CODICE CODE			CODICE CODE		
GRIGIO VESUVIO/ANTHRACITE	1140300001			1140300200			1140300300		
ARGILLA/ARGIL	1140301001			1140301200			1140301300		
ARGENTO OPACO/MATT SILVER	1140302001			1140302200			1140302300		
BIANCO INTONACO/WHITE	1140303001			1140303200			1140303300		
NERO CARAVAGGIO/BLACK	1140304001			1140304200			1140304300		
MOKA/MOCHA	1140305001			1140305200			1140305300		
ALLUMINIO NATURALE/ALUMINUM	1140306001			1140306200			1140306300		
ORO CALIFORNIA/GOLD	1140309001			1140309200			1140309300		
ARAMEN/COPPER	1140310001			1140310200			1140310300		
ARGENTO COMETA/SILVER COMET	1140312001			1140312200			1140312300		
OTTONE VENEZIANO/BRASS	1140313001			1140313200			1140313300		
TITANIO/TITANIUM	1140314001			1140314200			1140314300		
BRONZO RIACI/RIACI BRONZE	1140315001			1140315200			1140315300		
VERDE COSTA/GREEN COAST	1140316001			1140316200			1140316300		
TERRA SENESE/SENESE EARTH	1140317001			1140317200			1140317300		
CROMO/CHROME	1140308001			1140308200					

ATTENZIONE/PLEASE NOTE: LUNGHEZZA MASSIMA VERSIONE CROMO = 2,00 m / MAXIMUM LENGTH CHROME VERSION = 2.00 m
TESTATE DI CHIUSURA NON INCLUSE / DEAD ENDS NOT INCLUDED

DIFFUSORE

DIFFUSORE DIFFUSER	1 cm				200 cm				300 cm				400 cm			
	CODICE CODE				CODICE CODE				CODICE CODE				CODICE CODE			
OPALE/OPAL	1140100001				1140100200				1140100300				1140100400			
SATINATA/SATIN	1140101001				1140101200				1140101300				1140101400			



TESTATE DI CHIUSURA / DEAD ENDS

FINITURA STRUTTURA FINISHES	CODICE CODE	FINITURA STRUTTURA FINISHES	CODICE CODE
	GRIGIO VESUVIO/ANTHRACITE		1140400000
ARGILLA/ARGIL	1140401000	GRIGIO AVIO/GREY AVIO	1140411000
ARGENTO OPACO/MATT SILVER	1140402000	ARGENTO COMETA/SILVER COMET	1140412000
BIANCO INTONACO/WHITE	1140403000	OTTONE VENEZIANO/BRASS	1140413000
NERO CARAVAGGIO/BLACK	1140404000	TITANIO/TITANIUM	1140414000
MOKA/MOCHA	1140405000	BRONZO RIACI/RIACI BRONZE	1140415000
ALLUMINIO NATURALE/ALUMINUM	1140406000	VERDE COSTA/GREEN COAST	1140416000
CROMO/CHROME	1140408000	TERRA SENESE/SENESE EARTH	1140417000
ORO CALIFORNIA/GOLD	1140409000		

Il codice contiene 1 testata di chiusura con viti.
The code contains 1 closing warhead with screws.

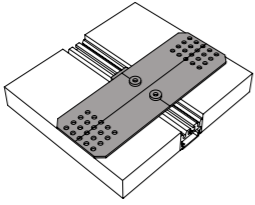

STAFFA INCASSO PER CARTONGESSO / SEMI-BASED BRACKET FOR PLASTERBOARD

DATI TECNICI TECHNICAL DATA	FINITURA STRUTTURA FINISHES	CODICE CODE
<p>Accessorio che consente l'incasso del modello. Accessory that allows the collection of the model.</p> <p>Nel codice sono comprese le viti per il fissaggio del modello alla staffa. The code includes screws for fixing the model to the bracket.</p> 	ALLUMINIO NATURALE/ALUMINUM	1090500001
<p>MOLLA PER INCASSO IN CARTONGESSO N°01 PZ SPRING FOR PLASTERBOARD INSTALLATION N°01 PZ</p> 	ALLUMINIO NATURALE/ALUMINUM	1140501

GIUNTI / JOINTS

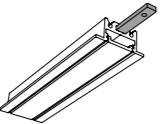
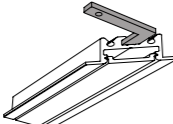
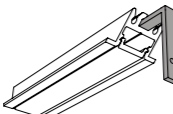
DATI TECNICI TECHNICAL DATA	FINITURA STRUTTURA FINISHES	CODICE CODE
<p>GIUNTO LINEA CONTINUA / STRAIGHT JOINT</p> <p>Accessorio per giunzioni meccaniche lineari Accessory for linear mechanical joints</p> 	ALLUMINIO NATURALE/ALUMINUM	1010500006
<p>GIUNTO 90° ORIZZONTALE / HORIZONTAL JOINT 90°</p> <p>Accessorio per giunzioni meccaniche con angolo 90° Accessory for linear mechanical joints with 90° angle</p> 	ALLUMINIO NATURALE/ALUMINUM	1010500005
<p>GIUNTO 90° VERTICALE / VERTICAL JOINT 90°</p> <p>Accessorio per giunzioni meccaniche con angolo 90° Accessory for linear mechanical joints with 90° angle</p> 	ALLUMINIO NATURALE/ALUMINUM	1010500007

Il codice contiene i grani per il fissaggio del giunto.
The code contains the grains to fix the joint.

INTERRUTTORE DIMMERABILE+INSTALLAZIONE / DIMMABLE SWITCH+INSTALLATION

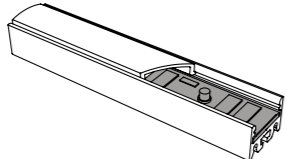
DATI TECNICI TECHNICAL DATA	FINITURA STRUTTURA FINISHES	CODICE CODE
<p>Accessorio che consente l'accensione e lo spegnimento dei LED e, a seconda della pressione, la regolazione dell'intensità luminosa. Accessory that allows the switching on and off of the LEDs and, depending on the pressure, the regulation of the light intensity.</p> <p>Tensione di alimentazione: 12-24V DC Supply voltage: 12-24V DC Corrente d'uscita: 4A max Output current: 4A max ON / OFF: contact < 0.7 s DIMMER: contact > 0.7 s</p> 	ALLUMINIO NATURALE/ALUMINUM	98244

STAFFA DI FISSAGGIO A DOPPIO ATTACCO / DOUBLE MOUNTING CLIP CALAMITA / MAGNET

FINITURA FINISHES	CODICE CODE	CODICE CODE	PORTATA RANGE
SUPERFICI PIANE 2mm EVEN SURFACE 2mm	1020500005	1020500010	1 Kg
SUPERFICI IRREGOLARI 3,9mm UNEVEN SURFACE 3,9mm	1020500006	1020500210	2 Kg

Accessorio per fissaggio a plafone/superficie. Quantità raccomandata: 1 pz ogni 50 cm di modello.

Ceiling/surface mounting accessory. Recommended quantity 1 pc every 50 cm of model.

Quantità raccomandata: 1 pz ogni 25 cm di modello
Recommended quantity: 1 pc every 25 cm of model

LAVORAZIONI / PROCESSING

DATI TECNICI TECHNICAL DATA	CODICE CODE
TAGLIO 90° ORIZZONTALE (PER ANGOLI FORMATI DA DUE PROFILI) HORIZONTAL 90 ° CUT (FOR CORNERS MADE OF TWO PROFILES)	190X
TAGLIO 90° VERTICALE (PER ANGOLI FORMATI DA DUE PROFILI) VERTICAL 90 ° CUT (FOR CORNERS MADE OF TWO PROFILES)	190Y
TAGLIO ANGOLARE CUSTOM (PER ANGOLI FORMATI DA DUE PROFILI) CUSTOM CORNER CUT (FOR CORNERS MADE OF TWO PROFILES)	190N
FORO / HOLE	100F
ASOLA / SLOT	100A
ASOLA CUSTOM / SLOT CUSTOM	100N
CABLAGGIO - COLLAUDO - CE AL CENTIMETRO INSTALLATION AND TESTING LED MODULE AT CENTIMETER	1141
CAVO DI ALIMENTAZIONE 2X0,50 BIANCO 1CM POWER CABLE 2X0,50 WHITE 1CM	98CB001
CAVO DI ALIMENTAZIONE 2X0,50 NERO 1CM POWER CABLE 2X0,50 BLACK 1CM	98CN001
CAVO DI ALIMENTAZIONE 2X0,75 MARRONE 1CM POWER CABLE 2X0,75 BROWN 1CM	98CS001

“preziose finiture”

Una sospensione minimale con un tocco di personalità inconfondibile. MIRA ha un diffusore che si allarga dal sostegno metallico per consentire una maggiore diffusione della luce. Ne risulta una luminosità “morbida” con una presenza leggermente sofisticata. Negli ambienti di lavoro o commerciali può essere utilizzata con successo. Grazie alle preziose finiture, come il cavo in stoffa, tiranti in acciaio e rosone, diventa un arredo di pregio negli ambienti domestici. Temperatura di colore calda K3000.

A minimal suspended lamp with an unmistakable touch of personality: MIRA has a diffuser extending out of the metallic truck to obtain a large light expansion. The result is a soft light sophisticated presence. It could be a real success in working spaces or commercial areas. Thanks to precious trimmings: fabric cable, steel tie-rod, cable holder, Mirage becomes a luxury furniture object for domestic use. Warm light colour K3000.



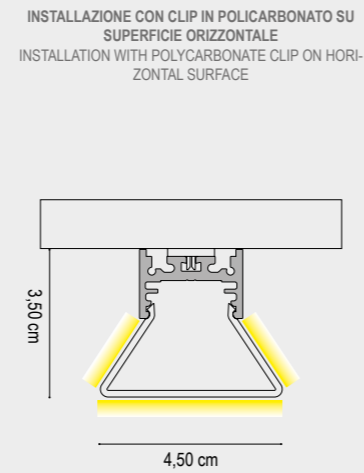
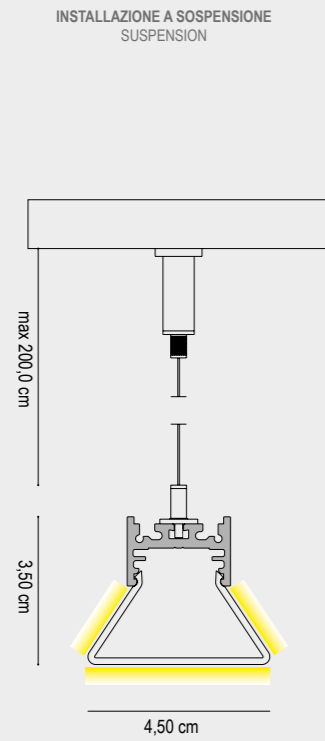

INSTALLAZIONE CON STAFFA MAGNETICA SU SUPERFICIE METALLICA ORIZZONTALE
INSTALLATION WITH MAGNET ON HORIZONTAL METAL SURFACE

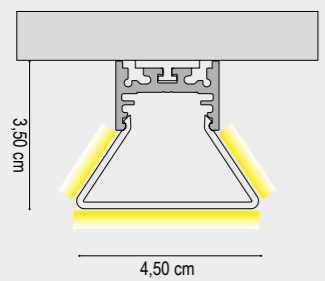

SI RACCOMANDA L'UTILIZZO DI N° 1 STAFFA
MAGNETICA OGNI 25,00 cm DI PROFILO. TALE
QUANTITÀ PUÒ VARIARE A SECONDA DELLA
SUPERFICIE METALLICA DI INSTALLAZIONE.

WE RECOMMEND THE USE OF N° 1 MAGNE-
TIC BRACKET EVERY 25.00 cm OF PROFILE.
THIS QUANTITY MAY VARY DEPENDING ON
THE METAL INSTALLATION SURFACE.

INSTALLAZIONE A PARETE CON STAFFA ORIENTABILE
WALL INSTALLATION WITH ADJUSTABLE BRACKET

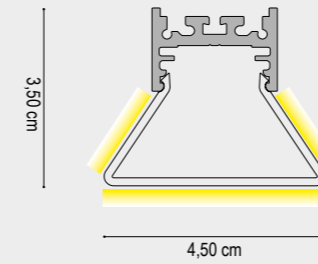
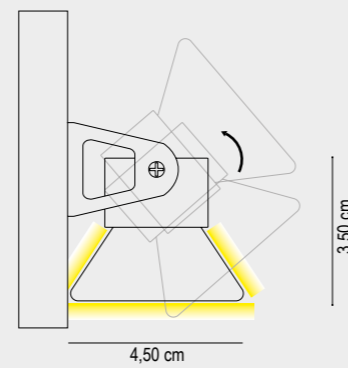

DATI TECNICI
TECHNICAL DATA

	1 cm	1 cm	1 cm
LED Flux Tot:	2090 lm/m	2200 lm/m	2440 lm/m
Flux Tot:	1670 lm/m	1760 lm/m	1950 lm/m
Output:	105 lm/W	105 lm/W	105 lm/W
CCT:	2700 K	3000 K	4000 K
CRI:	>90	>90	>90
Power Tot:	20.0 W/m	20.0 W/m	20.0 W/m
Weight:	0.80 Kg/m	0.80 Kg/m	0.80 Kg/m

Alluminio/aluminum
Cover: Opale/opal

DRIVER NON INCLUSO / NOT INCLUDED

CAVO ALIMENTAZIONE : 50 cm
ALIMENTATION CABLE : 50cm

FINITURA STRUTTURA
FINISHES

- GRIGIO VESUVIO ANTHRACITE
- ARGILLA CLAY
- ARGENTO OPACO MATT SILVER
- BIANCO INTONACO/WHITE
- NERO CARAVAGGIO BLACK
- MOKA MOCHA
- CROMO CHROME
- ORO CALIFORNIA/GOLD
- ARAMEN COPPER
- ARGENTO COMETA/SILVER COMET
- OTTONE VENEZIANO BRASS
- TITANIO/TITANIUM
- BRONZO RIACI/RIACI BRONZE
- VERDE COSTA/GREEN COAST
- TERRA SENESE/SENESE EARTH

DIFFUSORE
DIFFUSER

- OPALE/OPAL

1 cm - 2700K

CODICE
CODE

- 1034600501
- 1034601501
- 1034602501
- 1034603501
- 1034604501
- 1034605501
- 1034608501
- 1034609501
- 1034610501
- 1034612501
- 1034613501
- 1034614501
- 1034615501
- 1034616501
- 1034617501

1 cm - 3000K

CODICE
CODE

- 1034700501
- 1034701501
- 1034702501
- 1034703501
- 1034704501
- 1034705501
- 1034708501
- 1034709501
- 1034710501
- 1034712501
- 1034713501
- 1034714501
- 1034715501
- 1034715501
- 1034717501

1 cm - 4000K

CODICE
CODE

- 1034800501
- 1034801501
- 1034802501
- 1034803501
- 1034804501
- 1034805501
- 1034808501
- 1034809501
- 1034810501
- 1034812501
- 1034813501
- 1034814501
- 1034815501
- 1034816501
- 1034817501

N.B./P.N.: LUNGHEZZA MASSIMA VERSIONE CROMO = 2,00 m / MAXIMUM LENGTH CHROME VERSION = 2.00 m
TESTATE DI CHIUSURA NON INCLUSE / DEAD ENDS NOT INCLUDED

TESTATE DI CHIUSURA / DEAD ENDS

FINITURA STRUTTURA FINISHES	CODICE CODE	FINITURA STRUTTURA FINISHES	CODICE CODE
GRIGIO VESUVIO/ANTHRACITE	1030400100	ARAMEN/COPPER	1030410100
ARGILLA/ARGIL	1030401100	GRIGIO AVIO/GREY AVIO	1030411100
ARGENTO OPACO/MATT SILVER	1030402100	ARGENTO COMETA/SILVER COMET	1030412100
BIANCO INTONACO/WHITE	1030403100	OTTONE VENEZIANO/BRASS	1030413100
NERO CARAVAGGIO/BLACK	1030404100	TITANIO/TITANIUM	1030414100
MOKA/MOCHA	1030405100	BRONZO RIACI/RIACI BRONZE	1030415100
CROMO/CHROME	1030408100	VERDE COSTA/GREEN COAST	1030416100
ORO CALIFORNIA/GOLD	1030409100	TERRA SENESE/SENESE EARTH	1030417100

Il codice contiene 1 testata di chiusura con viti.
The code contains 1 closing warhead with screws.

STAFFA DI FISSAGGIO A DOPPIO ATTACCO / DOUBLE MOUNTING CLIP

FINITURA FINISHES	CODICE CODE
SUPERFICI PIANE 2mm EVEN SURFACE 2mm	1020500005
SUPERFICI IRREGOLARI 3,9mm UNEVEN SURFACE 3,9mm	1020500006

Accessorio per fissaggio a plafone/superficie. Quantità raccomandata: 1 pz ogni 50 cm di modello.

Ceiling/surface mounting accessory. Recommended quantity 1 pc every 50 cm of model.

KIT SOSPENSIONE / SUSPENSION KIT

DATI TECNICI
TECHNICAL DATA

ARTICOLI INCLUSI NEL CODICE
ARTICLES INCLUDED IN THE CODE

Cavo in acciaio 2,00m con puntalino
2.00m steel cable with tip

Boccola cromata con regolazione millimetrica
Chrome bush with millimeter adjustment

Archetto in alluminio per sospensione
Aluminum arch for suspension

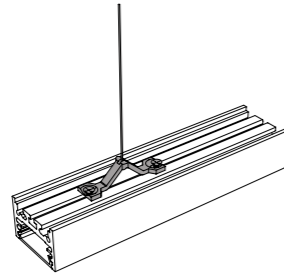

CALAMITA / MAGNET

CODICE CODE	PORTATA RANGE
1020500010	1 Kg
1020500210	2 Kg

Quantità raccomandata: 1 pz ogni 25 cm di modello
Recommended quantity: 1 pc every 25 cm of model

FINITURA STRUTTURA
FINISHESCODICE
CODE

GRIGIO VESUVIO/ANTHRACITE	1040500004
ARGILLA/ARGIL	1040501004
ARGENTO OPACO/MATT SILVER	1040502004
BIANCO INTONACO/WHITE	1040503004
NERO CARAVAGGIO/BLACK	1040504004
MOKA/MOCHA	1040505004
CROMO/CHROME	1040508004
ORO CALIFORNIA/GOLD	1040509004
ARAMEN/COPPER	1040510004
ARGENTO COMETA/SILVER COMET	1030712004
OTTONE VENEZIANO/BRASS	1030713004
TITANIO/TITANIUM	1090714004
BRONZO RIACI/RIACI BRONZE	1090715004
VERDE COSTA/GREEN COAST	1090716004
TERRA SENESE/SENESE EARTH	1040517004

STAFFA A PARETE REGOLABILE / ADJUSTABLE WALL BRACKET

DATI TECNICI
TECHNICAL DATA

MATERIALE: Alluminio naturale
MATERIAL: Natural aluminum

ARTICOLI INCLUSI NEL CODICE
ARTICLES INCLUDED IN THE CODE

N°1 staffa regolabile in alluminio
N°1 adjustable aluminium bracket
Viti per il fissaggio
Screw to fix

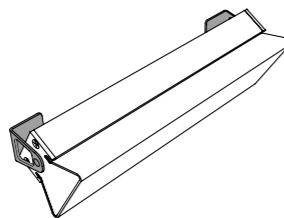
FINITURA STRUTTURA
FINISHESCODICE
CODE

GRIGIO VESUVIO/ANTHRACITE	1030500005
ARGILLA/ARGIL	1030501005
ARGENTO OPACO/MATT SILVER	1030502005
BIANCO INTONACO/WHITE	1030503005
NERO CARAVAGGIO/BLACK	1030504005
MOKA/MOCHA	1030505005
CROMO/CHROME	1030508005
ORO CALIFORNIA/GOLD	1030509005
ARAMEN/COPPER	1030510005
GRIGIO AVIO/GREY AVIO	1030511005
ARGENTO COMETA/SILVER COMET	1030512005
OTTONE VENEZIANO/BRASS	1030513005
TITANIO/TITANIUM	1030514005
BRONZO RIACI/RIACI BRONZE	1030515005
VERDE COSTA/GREEN COAST	1030516005
TERRA SENESE/SENESE EARTH	1030517005

GIUNTI / JOINTS

GIUNTO LINEA CONTINUA / STRAIGHT JOINT
Accessorio per giunzioni meccaniche lineari
Accessory for linear mechanical joints

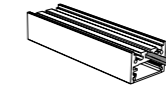
FINITURA
FINISHESCODICE
CODE

ALLUMINIO NATURALE/ALUMINUM

1010500006

GIUNTO 90° ORIZZONTALE / HORIZONTAL JOINT 90°
Accessorio per giunzioni meccaniche con angolo 90°
Accessory for linear mechanical joints with 90° angle

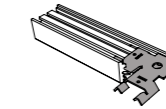

ALLUMINIO NATURALE/ALUMINUM

1030500006

Il codice contiene i grani per il fissaggio del giunto.
The code contains the grains to fix the joint.



**“massima espressione tecnologica
della microestrusione dell’alluminio”**

MC01, l'entry level dei nostri profili in alluminio. Compatto e flessibile. MC01 è la massima espressione tecnologica della microestrusione dell'alluminio, finalizzata alla dissipazione termica. Abbinato alla cover in policarbonato assicura una luce morbida e diffusa.

MC01, our aluminum profile entry level. Compact and for all around applications. MC01 expresses the best technology for micro-extruded aluminum profiles finalized for heat dissipation. With the selection of polycarbonate covers it ensures a smooth and diffused light.



mc01



VERSIONE KIT / KIT VERSION

ARTICOLI INCLUSI NEL CODICE
ARTICLES INCLUDES IN THE CODE
Modello: Alluminio / Model: Aluminium
Cover: Satinato / Satin

PER LUNGHEZZA 2,00m
N°2 testate di chiusura / No.2 closing heads
N°2 staffe di fissaggio / N°2 fixing brackets

PER LUNGHEZZA 3,00m
N°2 testate di chiusura / No.2 closing heads
N°3 staffe di fissaggio / N°3 fixing brackets

FINITURA STRUTTURA FINISHES	DIFFUSORE DIFFUSER	200 cm		300 cm	
		CODICE CODE		CODICE CODE	
ARGENTO OPACO/MATT SILVER	SATINATA/SATIN	1280111202		1280111302	
BIANCO INTONACO/WHITE		1280111203		1280111303	
NERO CARAVAGGIO BLACK		1280111204		1280111304	

TESTATE DI CHIUSURA / DEAD ENDS

FINITURA FINISHES	CODICE CODE	FINITURA FINISHES	CODICE CODE
BIANCO/WHITE	1280000002	BIANCO/WHITE	1280000001

Il codice contiene n° 1 testate di chiusura.
The code contains 1 closing warheads

STAFFA DI FISSAGGIO A PARETE / WALL MOUNTING CLIP

DATI TECNICI TECHNICAL DATA	FINITURA STRUTTURA FINISHES	CODICE CODE
MATERIALE: Alluminio naturale MATERIAL: Natural aluminum	ALLUMINIO NATURALE/ALUMINUM	1280000003

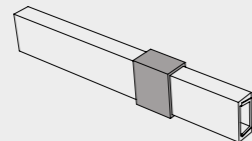

mc01

STAFFA DI FISSAGGIO A PARETE REGOLABILE / ADJUSTABLE WALL MOUNTING CLIP

DATI TECNICI
TECHNICAL DATA

MATERIALE: Alluminio naturale
MATERIAL: Natural aluminum

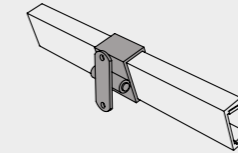

FINITURA STRUTTURA
FINISHES

ALLUMINIO NATURALE/ALUMINUM

CODICE
CODE

1280000004



mc02



VERSIONE KIT / KIT VERSION

ARTICOLI INCLUSI NEL CODICE ARTICLES INCLUDES IN THE CODE		FINITURA STRUTTURA FINISHES	DIFFUSORE DIFFUSER	CODICE CODE	200 cm
Modello: Alluminio / Model: Aluminium Cover: Satinato / Satin PER LUNGHEZZA 2,00m N°2 testate di chiusura / No.2 closing heads N°2 staffe di fissaggio / N°2 fixing brackets		ARGENTO OPACO/MATT SILVER	SATINATA/SATIN	1270111202	

TESTATE DI CHIUSURA / DEAD ENDS

FINITURA FINISHES	CODICE CODE	FINITURA FINISHES	CODICE CODE
GRIGIO/GREY	1270000002	GRIGIO/GREY	1270000001

Il codice contiene n° 1 testate di chiusura.
The code contains 1 closing warheads

STAFFA DI FISSAGGIO / MOUNTING CLIP

DATI TECNICI TECHNICAL DATA	FINITURA STRUTTURA FINISHES	CODICE CODE
MATERIALE: Alluminio naturale MATERIAL: Natural aluminum 	ALLUMINIO NATURALE/ALUMINUM	1270000003

mc02

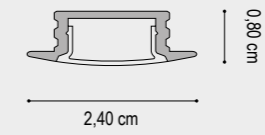

INSTALLAZIONE AD INCASSO
RECESSED INSTALLATION

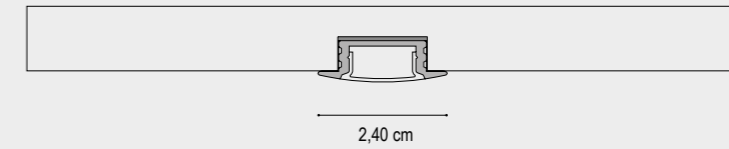

INSTALLAZIONE STAFFA DI FISSAGGIO A INCASSO
INSTALLATION OF RECESSED FIXING BRACKET

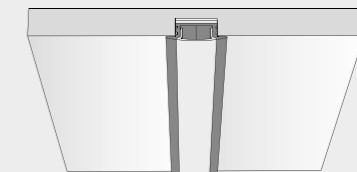
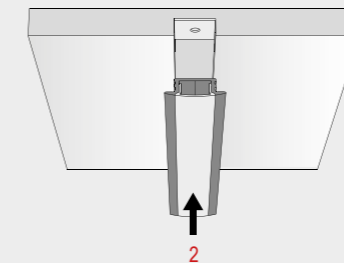
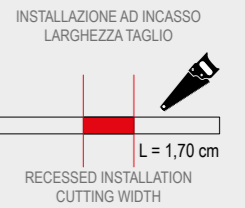
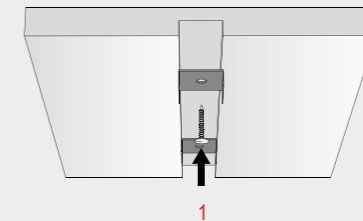

1. ESEGUIRE I TAGLI A CARTONGESSO PER L'INSERIMENTO DEL PRODOTTO. LA LARGHEZZA DEL TAGLIO DOVRÀ ESSERE DI 1,75 cm.
2. MAKE PLASTERBOARD CUTS FOR PRODUCT INSERTION. THE CUTTING WIDTH MUST BE 1,75 cm.
2. FISSARE IL PROFILO ALLE STAFFE. IL SISTEMA È A SCATTO.
2. FIX THE PROFILE TO THE BRACKETS. THE SYSTEM IS CLICKING.

mf01

**“massima espressione tecnologica
della microestruzione flessibile
dell’alluminio”**

MF01 è il più piccolo prodotto flessibile della nostra nuova gamma di profili in alluminio. È la massima espressione tecnologica della microestruzione flessibile dell’alluminio, finalizzata alla dissipazione termica. Le sue ridotte dimensioni e la possibilità di essere curvato lo rendono unico e sicuramente molto apprezzato e usato dai progettisti.

MF01 is the smallest flexible product in our new range of aluminum profiles. It's the maximum of aluminum microextrusion's technological expression, aimed to dissipate heat in the right mode. The small size and the ability to be curved, makes it unique and it will be certainly appreciated very much by designers.

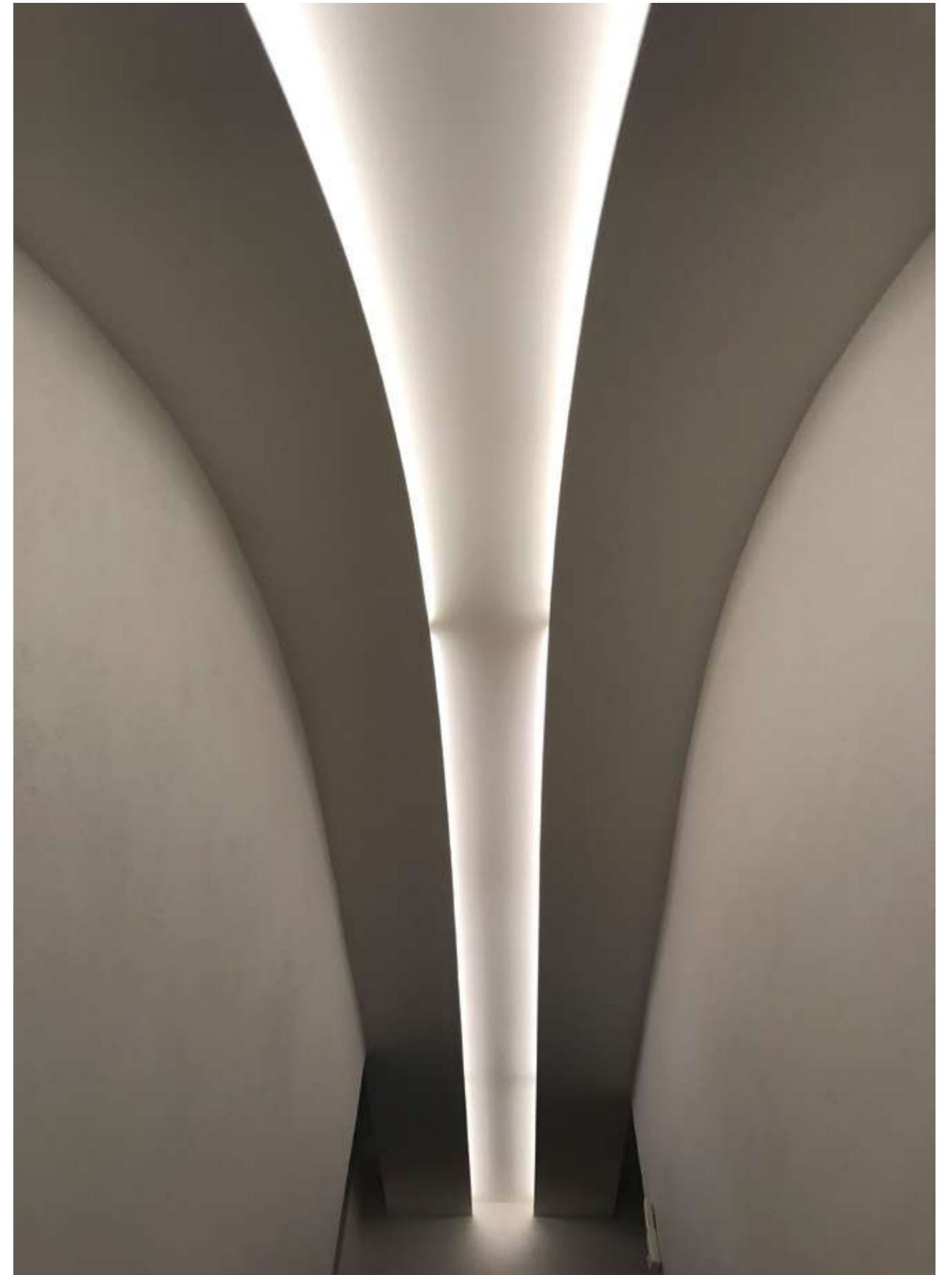

mf01

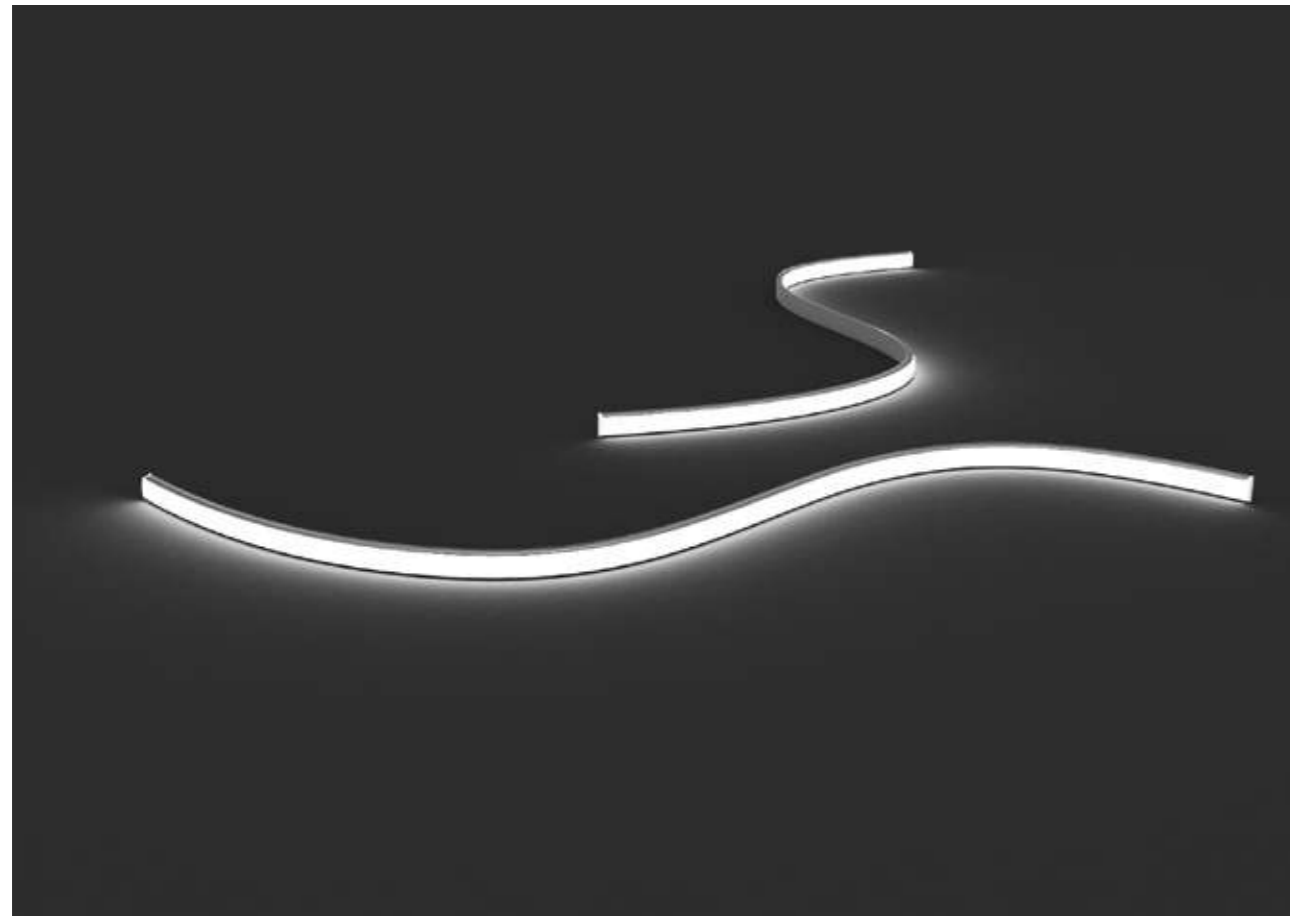

mf01

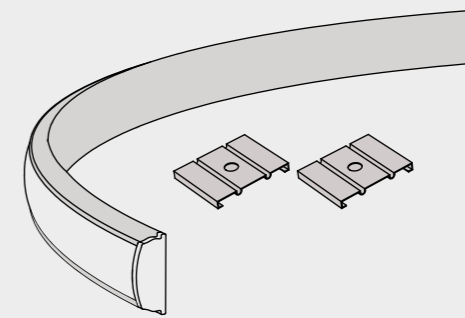
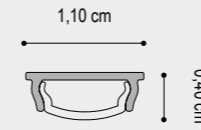

VERSIONE KIT / KIT VERSION

ARTICOLI INCLUSI NEL CODICE
ARTICLES INCLUDES IN THE CODE
Modello: Alluminio / Model: Aluminium
Cover: Satinato / Satin

PER LUNGHEZZA 2,00m
N°2 testate di chiusura / No.2 closing heads
N°2 staffe di fissaggio / N°2 fixing brackets

PER LUNGHEZZA 3,00m
N°2 testate di chiusura / No.2 closing heads
N°3 staffe di fissaggio / N°3 fixing brackets

FINITURA STRUTTURA
FINISHES

- ARGENTO OPACO/MATT SILVER
- BIANCO INTONACO/WHITE
- NERO CARAVAGGIO/BLACK

DIFFUSORE
DIFFUSER

- SATINATA/SATIN

CODICE
CODE

- 1280102200
- 1280103200
- 1280104200

200 cm

TESTATE DI CHIUSURA / DEAD ENDS

FINITURA FINISHES	CODICE CODE	FINITURA FINISHES	CODICE CODE
 BIANCO/WHITE	1280100001	 BIANCO/WHITE	1280100002

Il codice contiene n° 1 testate di chiusura.
The code contains 1 closing warheads

STAFFA DI FISSAGGIO A PARETE / WALL MOUNTING CLIP

DATI TECNICI
TECHNICAL DATA

MATERIALE: Alluminio naturale
MATERIAL: Natural aluminum

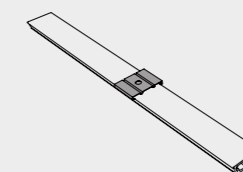

FINITURA STRUTTURA
FINISHES

- ALLUMINIO NATURALE/ALUMINUM

CODICE
CODE

- 1280100003



mf02

“ridotte dimensioni e possibilità di essere curvato”

MF02 è la massima espressione tecnologica della microestrusione flessibile dell'alluminio, finalizzata alla dissipazione termica. Le sue ridotte dimensioni e la possibilità di essere curvato lo rendono unico e sicuramente molto apprezzato e usato dai progettisti.

MF02 is the maximum of aluminum microextrusion's technological expression, aimed to dissipate heat in the right mode. The small size and the ability to be curved, makes it unique and it will be certainly appreciated very much by designers.



mf02



mf02

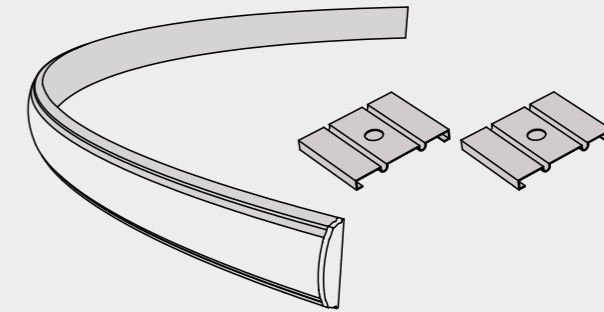
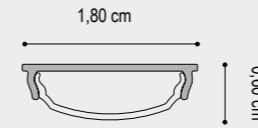

VERSIONE KIT / KIT VERSION

		200 cm	
ARTICOLI INCLUSI NEL CODICE ARTICLES INCLUDES IN THE CODE Modello: Alluminio / Model: Aluminium Cover: Satinato / Satin	FINITURA STRUTTURA FINISHES	DIFFUSORE DIFFUSER	CODICE CODE
PER LUNGHEZZA 2,00m N°2 testate di chiusura / No.2 closing heads N°2 staffe di fissaggio / N°2 fixing brackets	ARGENTO OPACO/MATT SILVER BIANCO INTONACO/WHITE NERO CARAVAGGIO/BLACK	SATINATA/SATIN	1281102200 1281103200 1281104200
PER LUNGHEZZA 3,00m N°2 testate di chiusura / No.2 closing heads N°3 staffe di fissaggio / N°3 fixing brackets			

TESTATE DI CHIUSURA / DEAD ENDS

FINITURA FINISHES	CODICE CODE	FINITURA FINISHES	CODICE CODE
 BIANCO/WHITE	1281100001	 BIANCO/WHITE	1281100002

Il codice contiene n° 1 testate di chiusura.
The code contains 1 closing warheads

STAFFA DI FISSAGGIO A PARETE / WALL MOUNTING CLIP

DATI TECNICI TECHNICAL DATA	FINITURA STRUTTURA FINISHES	CODICE CODE
MATERIALE: Alluminio naturale MATERIAL: Natural aluminum	ALLUMINIO NATURALE/ALUMINUM	1281100003

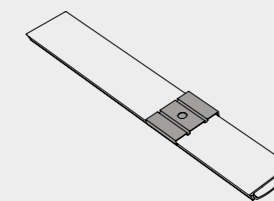

quadra

“illuminazione scenica e d’effetto”

QUADRA, la luce fa quadrato. Forma a sezione quadrata, semplice e pulita, con molte possibilità di personalizzazione sia nei colori che nelle sorgenti luminose. Può alloggiare lampade LED con attacco GU10 e consente un fissaggio rapido grazie al suo sistema di aggancio a scatto. Progettato per integrarsi sia in ambienti classici che moderni, QUADRA garantisce un’illuminazione scenica e d’effetto.

QUADRA, the light is square. Square section shape, simple and clean, with many customization possibilities both in colors and light sources. It can house LED lamps with GU10 socket and allows quick fixing thanks to its snap-on coupling system. Designed to integrate in both classic and modern environments, QUADRA guarantees scenic and effective lighting.

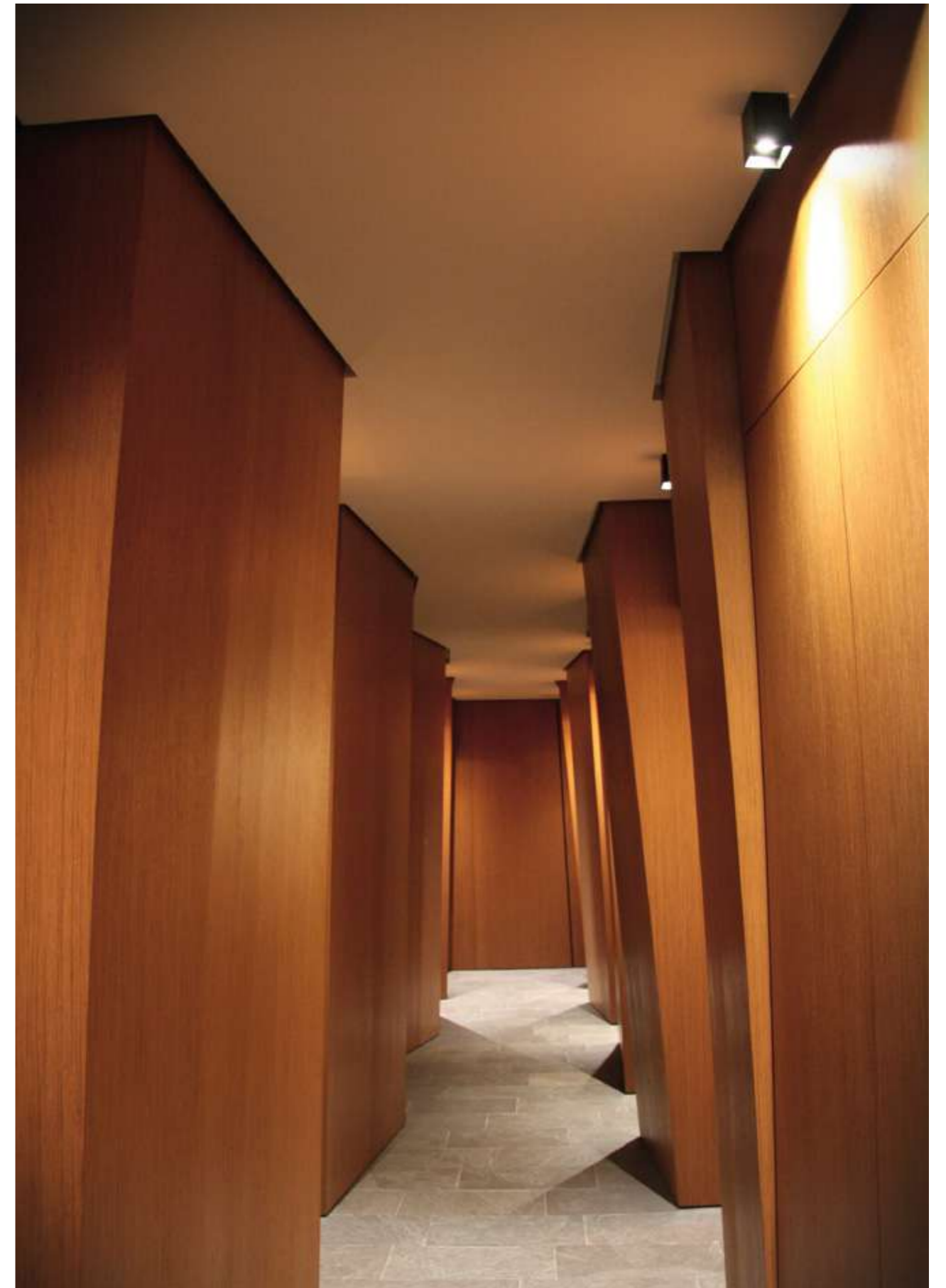



QUADRA 70

DIMENSIONI DIMENSIONS	ATTACCO SOCKET	TENSIONE - V VOLTAGE - V	FINITURA STRUTTURA FINISHES	CODICE CODE
<p>7,00 cm 7,00 cm 7,00 cm 11,00 cm 70 x 70 x 110 mm</p>	GU10	220 V	<p>BIANCO INTONACO/WHITE</p> <p>NERO CARAVAGGIO/BLACK</p> <p>MOKA/MOCHA</p> <p>ORO CALIFORNIA/GOLD</p> <p>TERRA SENESE/SENESE EARTH</p> <p>TITANIA/TITANIUM</p> <p>BRONZO RIACI/RIACI BRONZE</p> <p>VERDE COSTA/GREEN COAST</p> <p>ARGENTO COMETA/SILVER COMET</p>	<p>1007110010</p> <p>1007110020</p> <p>1007110040</p> <p>1007110090</p> <p>1007110170</p> <p>1007110014</p> <p>1007110015</p> <p>1007110016</p> <p>1007110120</p>

ARGENTO COMETA/SILVER COMET

QUADRA 80

DIMENSIONI DIMENSIONS	ATTACCO SOCKET	TENSIONE - V VOLTAGE - V	FINITURA STRUTTURA FINISHES	CODICE CODE
<p>8,00 cm 8,00 cm 8,00 cm 9,00 cm</p>	GU10	220 V	<p>BIANCO INTONACO/WHITE</p> <p>NERO CARAVAGGIO/BLACK</p> <p>MOKA/MOCHA</p> <p>ORO CALIFORNIA/GOLD</p> <p>TITANIA/TITANIUM</p> <p>BRONZO RIACI/RIACI BRONZE</p> <p>VERDE COSTA/GREEN COAST</p> <p>TERRA SENESE/SENESE EARTH</p>	<p>1008910010</p> <p>1008910020</p> <p>1008910040</p> <p>1008910090</p> <p>1008910014</p> <p>1008910015</p> <p>1008910016</p> <p>1008910170</p>

CORPO IN ALLUMINIO ESTRUSO VERNICIATO A POLVERI EPOSSIDICHE. FISSAGGIO RAPIDO.
IL PRODOTTO QUADRA VIENE FORNITO SPROVVISTO DI LAMPADA.

EXTRUDED ALUMINUM BODY PAINTED WITH EPOXY POWDERS. QUICK FASTENING.
QUADRA PRODUCT IS SUPPLIED WITHOUT LAMP.



faretti

hydria quadro

hydria tondo

flama quadro

flama tondo

“incasso per carongesso”

HYDRIA e FLAMA, da incasso per cartongesso in alluminio verniciato di forma tonda o quadrata equipaggiati con portalampe GU10 a tensione di rete o a 12V.

HYDRIA and FLAMA, recessed for plasterboard in painted aluminum, round or square, equipped with GU10 lamp holders at mains voltage or 12V.

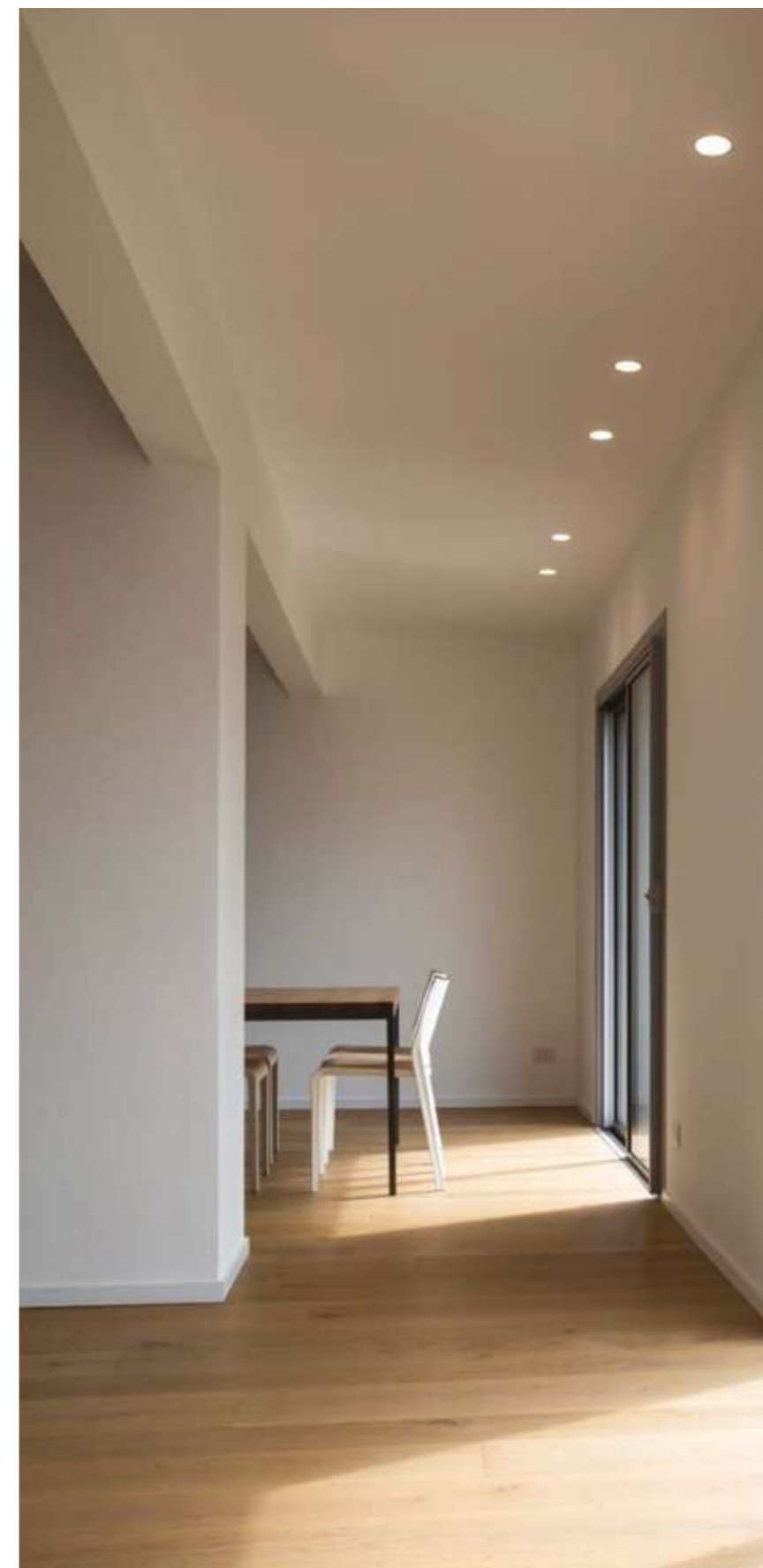

HYDRIA QUADRO

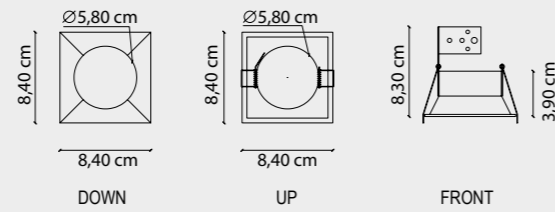

IL PRODOTTO VIENE FORNITO SPROVVISTO DI LAMPADA.
 THE PRODUCT IS SUPPLIED WITHOUT LAMP.

DIMENSIONE FORO HOLE DIMENSIONS	ALTEZZA (mm) HEIGHT (mm)	CARATTERISTICHE FEATURES	FINITURA FINISHES	ATTACCO ATTACK	CODICE CODE
 76 mm x 76 mm	90	12V MAX 50W	BIANCO/WHITE	GU 5,3	1080121211
			NERO/BLACK		1080121222
	110	220V MAX 50W	BIANCO/WHITE	GU 10	1080121112
			NERO/BLACK		1080121121

HYDRIA TONDO

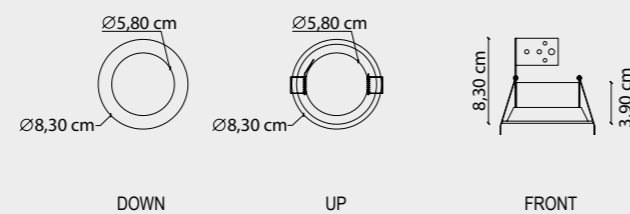

IL PRODOTTO VIENE FORNITO SPROVVISTO DI LAMPADA.
 THE PRODUCT IS SUPPLIED WITHOUT LAMP.

DIMENSIONE FORO HOLE DIMENSIONS	ALTEZZA (mm) HEIGHT (mm)	CARATTERISTICHE FEATURES	FINITURA FINISHES	ATTACCO ATTACK	CODICE CODE
 Ø 75 mm	90	12V MAX 50W	BIANCO/WHITE	GU 5,3	1080122211
			NERO/BLACK		1080122222
	110	220V MAX 50W	BIANCO/WHITE	GU 10	1080122112
			NERO/BLACK		1080122121

FLAMA QUADRO

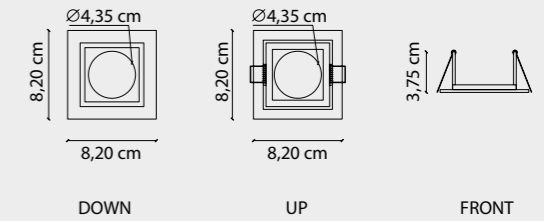

IL PRODOTTO VIENE FORNITO SPROVVISTO DI LAMPADA.
 THE PRODUCT IS SUPPLIED WITHOUT LAMP.

DIMENSIONE FORO HOLE DIMENSIONS	ALTEZZA (mm) HEIGHT (mm)	CARATTERISTICHE FEATURES	FINITURA FINISHES	ATTACCO ATTACK	CODICE CODE
 65 mm x 65 mm	60	12V MAX 50W	BIANCO/WHITE	GU 5,3	1090121211
			NERO/BLACK		1090121222
	90	220V MAX 50W	BIANCO/WHITE	GU 10	1090121112
			NERO/BLACK		1090121121

FLAMA TONDO

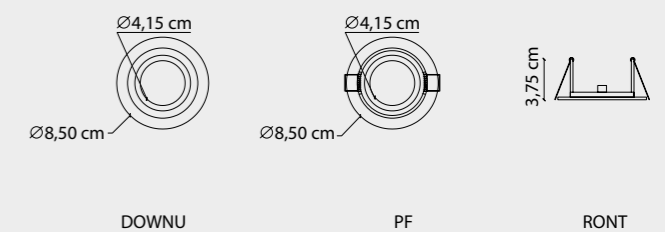

IL PRODOTTO VIENE FORNITO SPROVVISTO DI LAMPADA.
 THE PRODUCT IS SUPPLIED WITHOUT LAMP.

DIMENSIONE FORO HOLE DIMENSIONS	ALTEZZA (mm) HEIGHT (mm)	CARATTERISTICHE FEATURES	FINITURA FINISHES	ATTACCO ATTACK	CODICE CODE
 Ø 70 mm	60	12V MAX 50W	BIANCO/WHITE	GU 5,3	1090122211
			NERO/BLACK		1090122222
	90	220V MAX 50W	BIANCO/WHITE	GU 10	1090122112
			NERO/BLACK		1090122121

box di alimentazione + power supply box

BOX DI ALIMENTAZIONE / POWER SUPPLY BOX

DATI TECNICI TECHNICAL DATA	DIMENSIONI (In x lg x h) DIMENSIONS	FINITURA FINISHES	POTENZA POWER	CODICE CODE
Tensione/Voltage: 24V - CC SELV / 220-240v - 50-60 Hz Power Factor > 0.9 at > 50% load DC Operation 176-264v DC Ambient Temperature: -15°C to 60°C		BIANCO/WHITE NERO/BLACK	60 W ON/OFF	10403060 10404060
		BIANCO/WHITE NERO/BLACK	96 W ON/OFF	10403096 10404096
		BIANCO/WHITE NERO/BLACK	100 W DIMM	10403100 10404100
		BIANCO/WHITE NERO/BLACK	120 W ON/OFF	10403120 10404120
		BIANCO/WHITE NERO/BLACK	60 W DIMM	10403260 10404260
		BIANCO/WHITE NERO/BLACK	150 W DIMM	10403150 10404150
		BIANCO/WHITE NERO/BLACK	180 W	10403180 10404180

BOX COPRIMORSETTI / TERMINAL BOX

DATI TECNICI TECHNICAL DATA	DIMENSIONI (In x lg x h) DIMENSIONS	FINITURA FINISHES	CODICE CODE
Tensione/Voltage: 24V - CC SELV / 220-240v - 50-60 Hz Power Factor > 0.9 at > 50% load DC Operation 176-264v DC Ambient Temperature: -15°C to 60°C		BIANCO/WHITE NERO/BLACK	10403
			10404

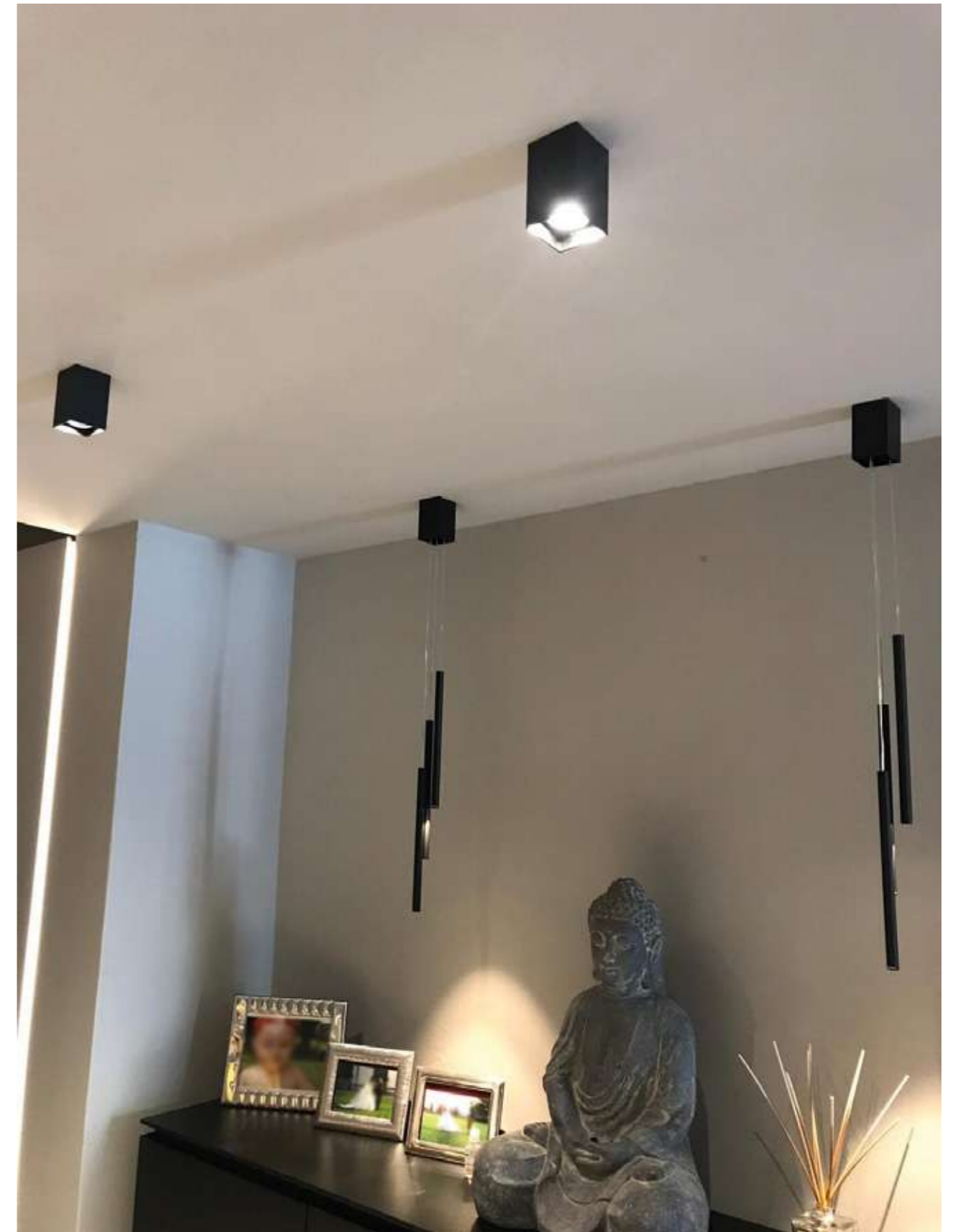

SISTEMI MODULARI MODULAR SYSTEM	LED FLESSIBILI IP20/IP54/IP65 FLEXIBLE LED IP20/IP54/IP65															
	HIGH QUALITY CRI>90 / 95			NEW HIGH OUTPUT/ TWO CHIPS CRI>90 / 95			HIGH EFFICIENT CRI>90 / 95			HIGH INTENSITY CRI>90 / 95		LOW POWER CRI>90	NEW ULTRA SLIM/ ONE CHIP CRI>90 / 95 / 97			
	9,6	14,4	19,2	12,3	14,4	20	24	32	12	19,2	21,6	20	24	6	7/9,6	12
K15														■	■	■
S21	■	■	■	■	■	■	■	■	■	■	■	■	■	■	■	■
K25	■	■	■	■	■	■	■	■	■	■	■	■	■	■	■	■
K40	■	■	■	■	■	■	■	■	■	■	■	■	■	■	■	■
Q20	■	■	■	■	■	■	■	■	■	■	■	■	■	■	■	■
CH012	■	■	■	■	■	■	■	■	■	■	■	■	■	■	■	■
SC015														■	■	■
LC020														■	■	■
LC014	■	■	■	■	■	■	■	■	■	■	■	■	■	■	■	■
MS07														■	■	■
MS08														■	■	■
MS09														■	■	■
MC01	■	■		■	■				■					■	■	■
MC02	■	■		■	■				■					■	■	■
MF01														■	■	■
MF02	■	■		■	■				■					■	■	■
STRUCTURAE	■	■	■	■	■	■	■	■	■	■	■	■	■	■	■	■
U01	■	■	■	■	■	■	■	■	■	■	■	■	■	■	■	■
U02/MIRA	■	■	■	■	■	■	■	■	■	■	■	■	■	■	■	■
U03	■	■	■	■	■	■	■	■	■	■	■	■	■	■	■	■
T24	■	■	■	■	■	■	■	■	■	■	■	■	■	■	■	■
KEPLER	■	■	■	■	■	■	■	■	■	■	■	■	■	■	■	■
ZER035/35X/35T	■	■	■	■	■	■	■	■	■	■	■	■	■	■	■	■
ZER035P/35XP	■	■	■	■	■	■	■	■	■	■	■	■	■	■	■	■
ZER055	■	■	■	■	■	■	■	■	■	■	■	■	■	■	■	■
ZER065/65P	■	■	■	■	■	■	■	■	■	■	■	■	■	■	■	■
ZER066	■	■	■	■	■	■	■	■	■	■	■	■	■	■	■	■
ZER075	■	■	■	■	■	■	■	■	■	■	■	■	■	■	■	■

SISTEMI MODULARI MODULAR SYSTEM	LED FLESSIBILI IP20/IP54/IP65 FLEXIBLE LED IP20/IP54/IP65												
	NEON CRI>90		NEON SLIM CRI> 90	RGB	RGB WHITE		RGB TW	TUNABLE WHITE			NEW 48V LED TWO CHIPS		
	10	15	8	14,4	14,4	23	14,4	19,2	24,0	30,0	8	12	19,2
K15			■										
S21	■	■	■	■	■	■	■	■	■	■	■	■	■
K25	■	■	■	■	■	■	■	■	■	■	■	■	■
K40	■	■	■	■	■	■	■	■	■	■	■	■	■
Q20	■	■	■	■	■	■	■	■	■	■	■	■	■
CH012	■	■	■	■	■	■	■	■	■	■	■	■	■
SC015			■										
LC020			■										
LC014	■	■	■	■	■	■	■	■	■	■	■	■	■
MS07			■										
MS08			■										
MS09			■										
MC01	■	■	■	■	■		■				■	■	
MC02	■	■	■	■	■		■				■	■	
MF01			■										
MF02	■	■	■	■	■		■				■	■	
STRUCTURAE	■	■	■	■	■	■	■	■	■	■	■	■	■
U01	■	■	■	■	■	■	■	■	■	■	■	■	■
U02/MIRA	■	■	■	■	■	■	■	■	■	■	■	■	■
U03	■	■	■	■	■	■	■	■	■	■	■	■	■
T24	■	■	■	■	■	■	■	■	■	■	■	■	■
KEPLER	■	■	■	■	■	■	■	■	■	■	■	■	■
ZER035/35X/35T	■	■	■	■	■	■	■	■	■	■	■	■	■
ZER035P/35XP	■	■	■	■	■	■	■	■	■	■	■	■	■
ZER055	■	■	■	■	■	■	■	■	■	■	■	■	■
ZER065/65P	■	■	■	■	■	■	■	■	■	■	■	■	■
ZER066	■	■	■	■	■	■	■	■	■	■	■	■	■
ZER075	■	■	■	■	■	■	■	■	■	■	■	■	■

led new generation flex led

“temperatura colore costante”

I nuovi led Flessibili, High Quality garantiscono una qualità della temperatura colore costante, che è fondamentale per valorizzare gli ambienti e il comfort visivo. Le Strip Led possono essere impiegate sia per scopi estetici che come fonte di illuminazione vera e propria, soprattutto anche in ambienti dove è sufficiente una luce soffusa e non troppo intensa, ma diffusa (come discoteche, cinema, sale o saloni). Si consiglia di usare le Strip Led in abbinamento ai profili d'alluminio per garantire una migliore dissipazione e un'ottimale durata del prodotto.

The new Flexible, High Quality LEDs guarantee a constant color temperature quality, which is fundamental for enhancing the environments and visual comfort. Strip LEDs can be used both for aesthetic purposes and as a real lighting source, especially even in environments where a soft and not too intense, but diffused light is sufficient (such as discos, cinemas, halls or salons). It is advisable to use the Led Strips in combination with the aluminum profiles to ensure better dissipation and optimal product life.



HIGH EFFICIENT 48V - L 1cm - IP20



DIMENSIONE E TAGLIO DIMENSION AND CUT	LED/m LED/m	OUTPUT (lm/W)	WATT (W/m)	IP IP	CRI CRI	LUMEN (lm/m)	CCT CCT	CODICE CODE	RIF. ENERGETICO ENERGY LABEL
 10 X 2 mm 250 mm L. max = 20m	60	105	11,4	20	94	1200	2700 K	9848122721	F
						1260	3000 K	9848123021	
						1360	4000 K	9848124221	
 10 X 2 mm 125 mm L. max = 20m	120	115	7,6	20	90	790	2700 K	9848082721	F
						840	3000 K	9848083021	
						880	4000 K	9848084221	

LED TWO CHIPS CUT 48V - L 1cm - IP20 **NEW**

DIMENSIONE E TAGLIO DIMENSION AND CUT	LED/m LED/m	OUTPUT (lm/W)	WATT (W/m)	IP IP	CRI CRI	LUMEN (lm/m)	CCT CCT	CODICE CODE	RIF. ENERGETICO ENERGY LABEL
 10 X 2 mm 11 mm L. max = 10m	180	135	8	20	90	1056	2700 K	98C4082721	E
						1080	3000 K	98C4083021	
						1144	4000 K	98C4084221	
 10 X 2 mm 11 mm L. max = 10m	180	128	8	20	95	1005	2700 K	98C4082921	E
						1025	3000 K	98C4083221	
						1090	4000 K	98C4083921	
 10 X 2 mm 8,3 mm L. max = 10m	240	135	12	20	90	1584	2700 K	98C4122721	E
						1620	3000 K	98C4123021	
						1716	4000 K	98C4124221	
 10 X 2 mm 8,3 mm L. max = 10m	240	128	12	20	95	1490	2700 K	98C4122921	E
						1530	3000 K	98C4123221	
						1716	4000 K	98C4123921	
 10 X 2 mm 11 mm L. max = 10m	180	135	19,2	20	90	2534	2700 K	98C4202721	E
						2592	3000 K	98C4203021	
						2746	4000 K	98C4204221	
 10 X 2 mm 11 mm L. max = 10m	180	130	19,2	20	95	2405	2700 K	98C4202921	E
						2460	3000 K	98C4203221	
						2610	4000 K	98C4203921	

HIGH EFFICIENT 48V - L 5m - IP20



DIMENSIONE E TAGLIO DIMENSION AND CUT	LED/m LED/m	OUTPUT (lm/W)	WATT (W/m)	IP IP	CRI CRI	LUMEN (lm/m)	CCT CCT	CODICE CODE	RIF. ENERGETICO ENERGY LABEL
 10 X 2 mm 250 mm L. max = 20m	60	105	11,4	20	94	1200	2700 K	9848122720	F
						1260	3000 K	9848123020	
						1360	4000 K	9848124220	
 10 X 2 mm 125 mm L. max = 20m	120	115	7,6	20	90	790	2700 K	9848082720	F
						840	3000 K	9848083020	
						880	4000 K	9848084220	

LED TWO CHIPS CUT 48V - L 10m - IP20 **NEW**

DIMENSIONE E TAGLIO DIMENSION AND CUT	LED/m LED/m	OUTPUT (lm/W)	WATT (W/m)	IP IP	CRI CRI	LUMEN (lm/m)	CCT CCT	CODICE CODE	RIF. ENERGETICO ENERGY LABEL
 10 X 2 mm 11 mm L. max = 10m	180	135	8	20	90	1056	2700 K	98C4082720	E
						1080	3000 K	98C4083020	
						1144	4000 K	98C4084220	
 10 X 2 mm 11 mm L. max = 10m	180	128	8	20	95	1005	2700 K	98C4082920	E
						1025	3000 K	98C4083220	
						1090	4000 K	98C4083920	
 10 X 2 mm 8,3 mm L. max = 10m	240	135	12	20	90	1584	2700 K	98C4122720	E
						1620	3000 K	98C4123020	
						1716	4000 K	98C4124220	
 10 X 2 mm 8,3 mm L. max = 10m	240	128	12	20	95	1490	2700 K	98C4122920	E
						1530	3000 K	98C4123220	
						1716	4000 K	98C4123920	
 10 X 2 mm 11 mm L. max = 10m	180	135	19,2	20	90	2534	2700 K	98C4202720	E
						2592	3000 K	98C4203020	
						2746	4000 K	98C4204220	
 10 X 2 mm 11 mm L. max = 10m	180	130	19,2	20	95	2405	2700 K	98C4202920	E
						2460	3000 K	98C4203220	
						2610	4000 K	98C4203920	

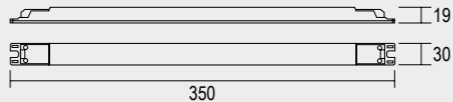
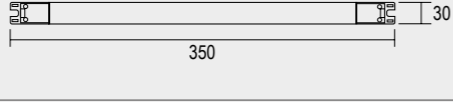
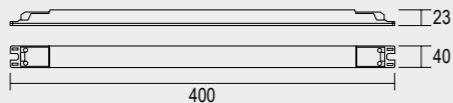
DATI TECNICI TECHNICAL DATA	DIMENSIONI (ln x lg x h) DIMENSIONS	POTENZA POWER	CODICE CODE
Tensione/Voltage: 48V - CC SELV / 220-240v - 50-60 Hz Power Factor > 0.9 at > 50% load DC Operation 176-264v DC Ambient Temperature: -15°C to 60°C Weight: 0.20 - 1.50 Kg		100 W	981004
		150 W	981504
		250 W	982504

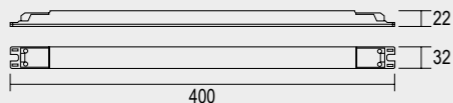
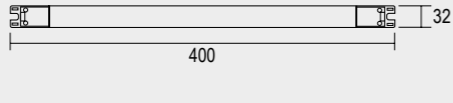
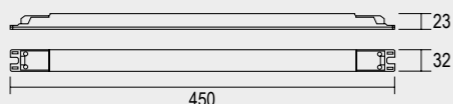
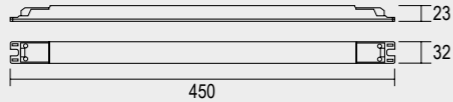





DATI TECNICI TECHNICAL DATA	DIMENSIONI (ln x lg x h) DIMENSIONS	POTENZA POWER	CODICE CODE
Tensione/Voltage: 48V - CC SELV / 220-240v - 50-60 Hz Power Factor > 0.9 at > 50% load DC Operation 176-264v DC Ambient Temperature: -15°C to 60°C Weight: 0.20 - 1.50 Kg		75 W	98074D
		100 W	98104D
		150 W	98154D
		200 W	98204D

CABLAGGI / WIRING

DATI TECNICI TECHNICAL DATA	CODICE CODE
 CABLAGGIO - COLLAUDO - LED IP > 20 INSTALLATION AND TESTING LED >20	98LEDIP
CABLAGGIO - COLLAUDO - LED IP > 20 DOPPIA ALIMENTAZIONE INSTALLATION AND TESTING LED IP>20 POWER SUPPLY	98LEDIP2
CABLAGGIO - COLLAUDO - LED IP20 DOPPIA ALIMENTAZIONE INSTALLATION AND TESTING LED POWER SUPPLY	98LED2

TENSIONE DI RETE - L 1cm - IP65



DIMENSIONE E TAGLIO DIMENSION AND CUT	LED/m LED/m	OUTPUT (lm/W)	WATT (W/m)	IP IP	CRI CRI	LUMEN (lm/m)	CCT CCT	CODICE CODE	RIF. ENERGETICO ENERGY LABEL
 15 X 6 mm  100 mm L. max = 50m	120	100	16	65	90	1150	 2700 K	9823162761	 F
						1200	 3000 K	9823163061	
						1300	 4000 K	9823164261	

TENSIONE DI RETE ACCESSORI / ACCESSORIES



TESTATA / END CAP INDOOR & OUTDOOR
CODICE / CODE 982300



TESTATA CON CAVO DI ALIMENTAZIONE /
END CAP WITH POWER CORD
CODICE / CODE 982301

TENSIONE DI RETE CONNETTORI / CONNECTORS



CONNETTORE AD "L" /
L SNAP CONNECTOR INDOOR
CODICE / CODE 982302



CONNETTORE A SPINA /
SPLICE CONNECTOR INDOOR
CODICE / CODE 982303



CONNETTORE A SPINA CON CAVO /
JUMPER INDOOR & OUTDOOR
CODICE / CODE 982304



TESTATA DI CHIUSURA CON CAVO DI ALIMENTAZIONE E SPINA /
END CAP WITH POWER PLUG INDOOR
CODICE / CODE 982305

flex led ip66

personalizzazione

custom

FLEX LED - L 5m - IP66



DIMENSIONE E TAGLIO DIMENSION AND CUT	LED/m LED/m	WATT (W/m)	IP IP	CRI CRI	LUMEN (lm/m)	CCT CCT	CODICE CODE	RIF. ENERGETICO ENERGY LABEL
 10 X 10 mm ✂ 100 mm	140	14,4	66	90	1180	3000 K	9924153066	

FLEX LED - L 1cm - IP66



DIMENSIONE E TAGLIO DIMENSION AND CUT	LED/m LED/m	WATT (W/m)	IP IP	CRI CRI	LUMEN (lm/m)	CCT CCT	CODICE CODE	RIF. ENERGETICO ENERGY LABEL
 10 X 10 mm ✂ 100 mm	140	14,4	66	90	1180	3000 K	9924153061	

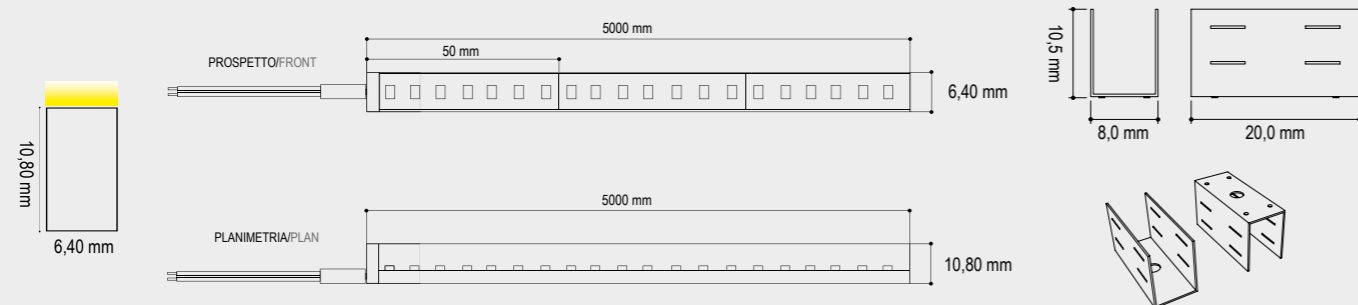

flex led ip65

personalizzazione

custom

FLEX LED 3D - L 5m - IP65



DIMENSIONE E TAGLIO DIMENSION AND CUT	LED/m LED/m	WATT (W/m)	IP IP	CRI CRI	LUMEN (lm/m)	CCT CCT	CODICE CODE	RIF. ENERGETICO ENERGY LABEL
 9 X 9 mm ✂ 100 mm	240	14,4	65	90	1160	2700 K	98NE152765	
					1180	3000 K	98NE153065	
					1200	4000 K	98NE154265	

FLEX LED 3D - L 1cm - IP65



DIMENSIONE E TAGLIO DIMENSION AND CUT	LED/m LED/m	WATT (W/m)	IP IP	CRI CRI	LUMEN (lm/m)	CCT CCT	CODICE CODE	RIF. ENERGETICO ENERGY LABEL
 9 X 9 mm ✂ 100 mm	240	14,4	65	90	1160	2700 K	98NE152761	
					1180	3000 K	98NE153061	
					1200	4000 K	98NE154261	

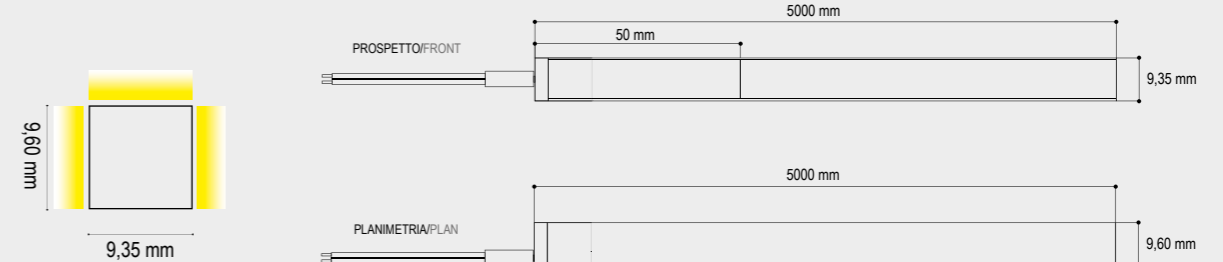

mini flex led ip65

personalizzazione

custom

MINI FLEX LED - L 3m - IP65



DIMENSIONE E TAGLIO DIMENSION AND CUT	LED/m LED/m	WATT (W/m)	IP	CRI	LUMEN (lm/m)	CCT	CODICE CODE	RIF. ENERGETICO ENERGY LABEL
 12 X 6 mm ✂ 100 mm	182	14,4	65	90	1160	2700 K	9905152765	
					1180	3000 K	9905153065	
					1200	4000 K	9905154265	

MINI FLEX LED - L 1cm - IP65



DIMENSIONE E TAGLIO DIMENSION AND CUT	LED/m LED/m	WATT (W/m)	IP	CRI	LUMEN (lm/m)	CCT	CODICE CODE	RIF. ENERGETICO ENERGY LABEL
 12 X 6 mm ✂ 100 mm	182	14,4	65	90	1160	2700 K	9905152761	
					1180	3000 K	9905153061	
					1200	4000 K	9905154261	

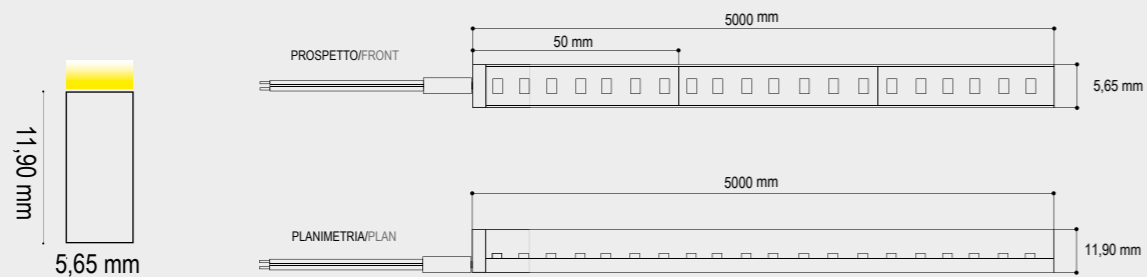

led new generation + mini flex led

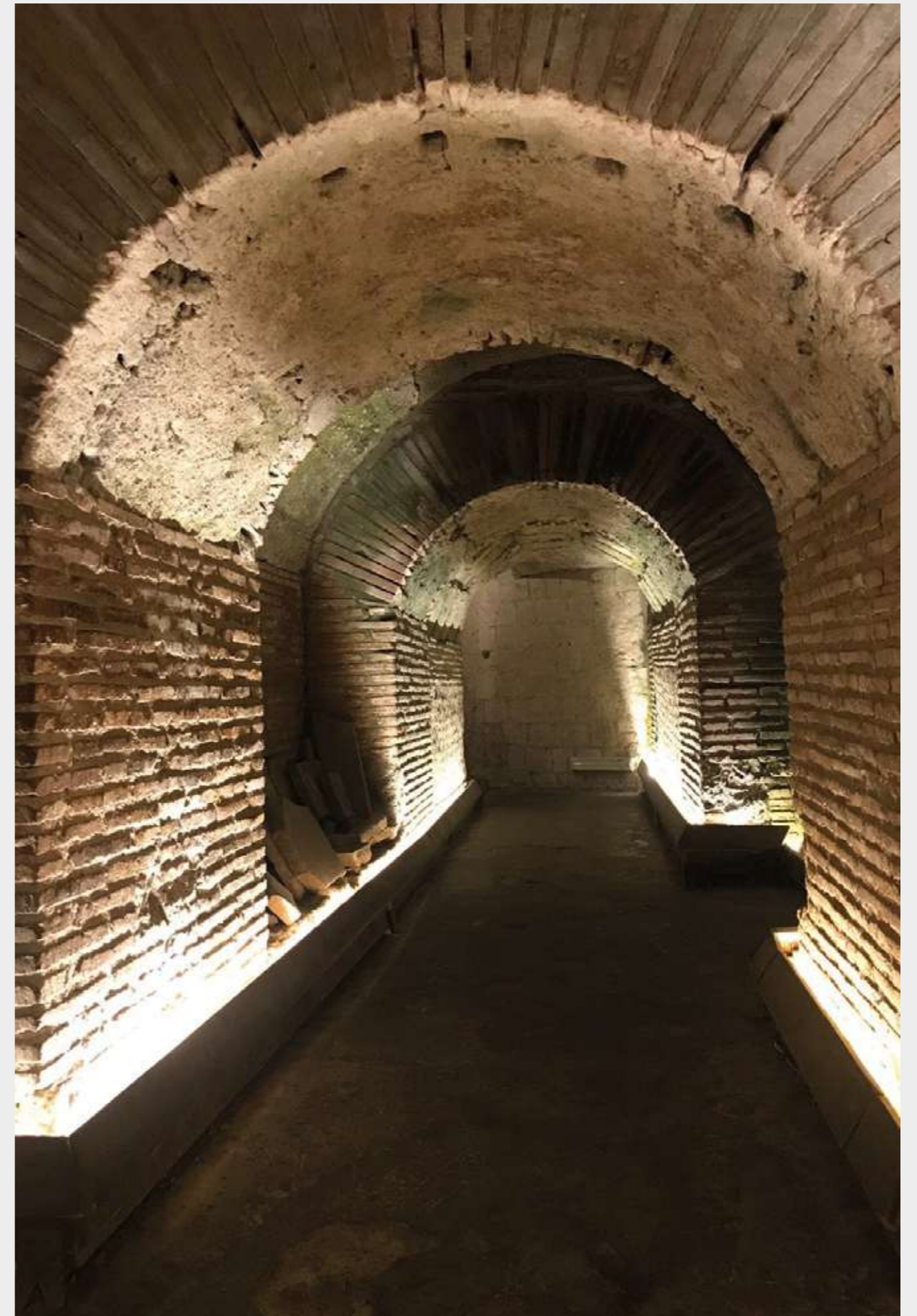

NEON - 24V - L 1cm - IP20



DIMENSIONE E TAGLIO DIMENSION AND CUT	LED/m LED/m	OUTPUT (lm/W)	WATT (W/m)	IP	CRI	LUMEN (lm/m)	CCT CCT	CODICE CODE	RIF. ENERGETICO ENERGY LABEL
 8 X 2 mm ✂ 50 mm		90	10,0	20	90	880	2700 K	98CB102721	
						900	3000 K	98CB103021	
						930	4000 K	98CB104221	
 10 X 2 mm ✂ 50 mm		90	15,0	20	90	1320	2700 K	98CB152721	
						1350	3000 K	98CB153021	
						1390	4000 K	98CB154221	

NEON - 24V - L 1cm - IP67



DIMENSIONE E TAGLIO DIMENSION AND CUT	LED/m LED/m	OUTPUT (lm/W)	WATT (W/m)	IP	CRI	LUMEN (lm/m)	CCT CCT	CODICE CODE	RIF. ENERGETICO ENERGY LABEL
 12 X 5 mm ✂ 50 mm		85	15,0	67	90	1245	2700 K	98CB152761	
						1275	3000 K	98CB153061	
						1320	4000 K	98CB154261	

NEON SLIM - 24V - L 1cm - IP20



DIMENSIONE E TAGLIO DIMENSION AND CUT	LED/m LED/m	OUTPUT (lm/W)	WATT (W/m)	IP	CRI	LUMEN (lm/m)	CCT CCT	CODICE CODE	RIF. ENERGETICO ENERGY LABEL
 4 X 2 mm ✂ 50 mm		95	8,0	20	90	744	2700 K	98CB082721	
						760	3000 K	98CB083021	
						840	4000 K	98CB084221	

Temperatura +/- 100 K - 3 step MacAdam / Temperature +/- 100 K - 3 MacAdam steps

CABLAGGI / WIRING

DATI TECNICI TECHNICAL DATA	CODICE CODE
CABLAGGIO - COLLAUDO - LED IP > 20 INSTALLATION AND TESTING LED >20	98LEDIP
CABLAGGIO - COLLAUDO - LED IP > 20 DOPPIA ALIMENTAZIONE INSTALLATION AND TESTING LED IP>20 POWER SUPPLY	98LEDIP2
CABLAGGIO - COLLAUDO - LED IP20 DOPPIA ALIMENTAZIONE INSTALLATION AND TESTING LED POWER SUPPLY	98LED2

NEON - 24V - L 5m - IP20



DIMENSIONE E TAGLIO DIMENSION AND CUT	LED/m LED/m	OUTPUT (lm/W)	WATT (W/m)	IP	CRI	LUMEN (lm/m)	CCT CCT	CODICE CODE	RIF. ENERGETICO ENERGY LABEL
 8 X 2 mm ✂ 50 mm		90	10,0	20	90	880	2700 K	98CB102720	
						900	3000 K	98CB103020	
						930	4000 K	98CB104220	
 10 X 2 mm ✂ 50 mm		90	15,0	20	90	1320	2700 K	98CB152720	
						1350	3000 K	98CB153020	
						1390	4000 K	98CB154220	

NEON - 24V - L 5m - IP67



DIMENSIONE E TAGLIO DIMENSION AND CUT	LED/m LED/m	OUTPUT (lm/W)	WATT (W/m)	IP	CRI	LUMEN (lm/m)	CCT CCT	CODICE CODE	RIF. ENERGETICO ENERGY LABEL
 12 X 5 mm ✂ 50 mm		85	15,0	67	90	1245	2700 K	98CB152765	
						1275	3000 K	98CB153065	
						1320	4000 K	98CB154265	

NEON SLIM - 24V - L 5m - IP20



DIMENSIONE E TAGLIO DIMENSION AND CUT	LED/m LED/m	OUTPUT (lm/W)	WATT (W/m)	IP	CRI	LUMEN (lm/m)	CCT CCT	CODICE CODE	RIF. ENERGETICO ENERGY LABEL
 4 X 2 mm ✂ 50 mm		95	8,0	20	90	744	2700 K	98CB042720	
						760	3000 K	98CB043020	
						840	4000 K	98CB044220	

Temperatura +/- 100 K - 3 step MacAdam / Temperature +/- 100 K - 3 MacAdam steps

SLIM LED ONE CHIP CUT 24V - L 1cm - IP20 NEW



DIMENSIONE E TAGLIO DIMENSION AND CUT	LED/m LED/m	OUTPUT (lm/W)	WATT (W/m)	IP	CRI	LUMEN (lm/m)	CCT CCT	CODICE CODE	RIF. ENERGETICO ENERGY LABEL
 5 X 2 mm ✂ 6,25 mm	160	125	7	20	90	840	2700 K	98S1072721	E
						875	3000 K	98S1073020	
						966	4000 K	98S1074221	

 5 X 2 mm ✂ 6,25 mm	160	115	7	20	95	800	2700 K	98S1072921	E
						790	3000 K	98S1073221	
						920	4000 K	98S1073921	

SLIM LED ONE CHIP CUT 24V - L 1cm - IP20 NEW



DIMENSIONE E TAGLIO DIMENSION AND CUT	LED/m LED/m	OUTPUT (lm/W)	WATT (W/m)	IP	CRI	LUMEN (lm/m)	CCT CCT	CODICE CODE	RIF. ENERGETICO ENERGY LABEL
 5 X 2 mm ✂ 5,5mm	180	133	9	20	90	1170	2700 K	98C1092721	E
						1197	3000 K	98C1093021	
						1260	4000 K	98C1094221	

 5 X 2 mm ✂ 5,5 mm	180	126	9	20	95	1110	2700 K	98S1092921	E
						1140	3000 K	98S1093221	
						1120	4000 K	98S1093921	

 10 X 2 mm ✂ 6,25 mm	180	125	19,2	20	90	2280	2700 K	98C1202721	E
						2400	3000 K	98C1203021	
						2530	4000 K	98C1204221	

 10 X 2 mm ✂ 11 mm	180	118	19,2	20	95	2270	2700 K	98C1202921	E
						2265	3000 K	98C1203221	
						2517	4000 K	98C1203921	

LED TWO CHIPS CUT 24V - L 1cm - IP20 NEW



DIMENSIONE E TAGLIO DIMENSION AND CUT	LED/m LED/m	OUTPUT (lm/W)	WATT (W/m)	IP	CRI	LUMEN (lm/m)	CCT CCT	CODICE CODE	RIF. ENERGETICO ENERGY LABEL
 10 X 2 mm ✂ 8,33 mm	240	135	14,4	20	90	1901	2700 K	98C2152721	E
						1944	3000 K	98C2153021	
						2060	4000 K	98C2154221	

 10 X 2 mm ✂ 8,33 mm	240	128	14,4	20	95	1805	2700 K	98C2152921	E
						1845	3000 K	98C2153221	
						1960	4000 K	98C2153921	

 10 X 2 mm ✂ 8,33 mm	240	135	24	20	90	3036	2700 K	98C2232721	E
						3105	3000 K	98C2233021	
						3289	4000 K	98C2234221	

 10 X 2 mm ✂ 8,33 mm	240	128	24	20	95	2885	2700 K	98C2232921	E
						2959	3000 K	98C2233221	
						3125	4000 K	98C2233921	

SLIM LED ONE CHIP CUT 24V - L 5m - IP20 NEW



DIMENSIONE E TAGLIO DIMENSION AND CUT	LED/m LED/m	OUTPUT (lm/W)	WATT (W/m)	IP	CRI	LUMEN (lm/m)	CCT CCT	CODICE CODE	RIF. ENERGETICO ENERGY LABEL
 5 X 2 mm ✂ 6,25 mm	160	125	7	20	90	840	2700 K	98S1072720	E
						875	3000 K	98S1073021	
						966	4000 K	98S1074220	

 5 X 2 mm ✂ 6,25mm	160	115	7	20	95	800	2700 K	98S1072920	E
						790	3000 K	98S1073220	
						920	4000 K	98S1073920	

SLIM LED ONE CHIP CUT 24V - L 5m - IP20 NEW



DIMENSIONE E TAGLIO DIMENSION AND CUT	LED/m LED/m	OUTPUT (lm/W)	WATT (W/m)	IP	CRI	LUMEN (lm/m)	CCT CCT	CODICE CODE	RIF. ENERGETICO ENERGY LABEL
 5 X 2 mm ✂ 5,5mm	240	133	12	20	90	1170	2700 K	98C1092720	E
						1197	3000 K	98C1093020	
						1260	4000 K	98C1094220	

 5 X 2 mm ✂ 5,5 mm	240	126	12	20	95	1110	2700 K	98S1092920	E
						1140	3000 K	98S1093220	
						1120	4000 K	98S1093920	

 10 X 2 mm ✂ 6,25 mm	160	125	19,2	20	90	2280	2700 K	98C1202720	E
						2400	3000 K	98C1203020	
						2530	4000 K	98C1204220	

 10 X 2 mm ✂ 11mm	160	118	19,2	20	95	2270	2700 K	98C1202920	E
						2265	3000 K	98C1203220	
						2517	4000 K	98C1203920	

LED TWO CHIPS CUT 24V - L 5m - IP20 NEW



DIMENSIONE E TAGLIO DIMENSION AND CUT	LED/m LED/m	OUTPUT (lm/W)	WATT (W/m)	IP	CRI	LUMEN (lm/m)	CCT CCT	CODICE CODE	RIF. ENERGETICO ENERGY LABEL
 10 X 2 mm ✂ 8,33 mm	240	135	14,4	20	90	1901	2700 K	98C2152720	E
						1944	3000 K	98C2153020	
						2060	4000 K	98C2154220	

 10 X 2 mm ✂ 8,33 mm	240	135	14,4	20	95	1805	2700 K	98C2152920	E
						1845	3000 K	98C2153220	
						1960	4000 K	98C2153920	

 10 X 2 mm ✂ 8,33 mm	240	135	24	20	90	3036	2700 K	98C2232720	E
						3105	3000 K	98C2233020	
						3289	4000 K	98C2234220	

 10 X 2 mm ✂ 8,33 mm	240	128	24	20	95	2885	2700 K	98C2232920	E
						2959	3000 K	98C2233220	
						3125	4000 K	98C2233920	

ULTRA SLIM HO - 24V - L 1cm - IP20



DIMENSIONE E TAGLIO DIMENSION AND CUT	LED/m LED/m	OUTPUT (lm/W)	WATT (W/m)	IP	CRI	LUMEN (lm/m)	CCT CCT	CODICE CODE	RIF. ENERGETICO ENERGY LABEL
 5 X 2 mm ✂ 50 mm	160	120	6,0	20	90	690	2700 K	9805062721	F
						720	3000 K	9805063021	
						750	4000 K	9805064221	
 5 X 2 mm ✂ 60 mm	128	105	7,6	20	90	780	2700 K	9805072721	F
						800	3000 K	9805073021	
						820	4000 K	9805074221	
 5 X 2 mm ✂ 50 mm	160	115	9,6	20	90	1075	2700 K	9805092721	F
						1104	3000 K	9805093021	
						1200	4000 K	9805094221	
 5 X 2 mm ✂ 50 mm	160	110	9,6	20	95	1021	2700 K	9805092921	F
						1050	3000 K	9805093221	
						1140	4000 K	9805093921	
 5 X 2 mm ✂ 50 mm	160	110	14,4	20	90	1426	2700 K	9805142721	F
						1584	3000 K	9805143021	
						1740	4000 K	9805144221	
 5 X 2 mm ✂ 50 mm	160	105	14,4	20	95	1355	2700 K	9805142921	F
						1505	3000 K	9805143221	
						1655	4000 K	9805143921	
 5 X 2 mm ✂ 50 mm	160	105	14,4	20	90	1460	2700 K	98H5142721	F
						1510	3000 K	98H5143021	
						1560	4000 K	98H5144221	

ULTRA SLIM HO - 24V - L 5m - IP20



DIMENSIONE E TAGLIO DIMENSION AND CUT	LED/m LED/m	OUTPUT (lm/W)	WATT (W/m)	IP	CRI	LUMEN (lm/m)	CCT CCT	CODICE CODE	RIF. ENERGETICO ENERGY LABEL
 5 X 2mm ✂ 50 mm	160	120	6,0	20	90	690	2700 K	9805062720	F
						720	3000 K	9805063020	
						750	4000 K	9805064220	
 5 X 2 mm ✂ 60 mm	128	105	7,6	20	90	780	2700 K	9805072720	F
						800	3000 K	9805073020	
						820	4000 K	9805074220	
 5 X 2 mm ✂ 50 mm	160	115	9,6	20	90	1075	2700 K	9805092720	F
						1104	3000 K	9805093020	
						1200	4000 K	9805094220	
 5 X 2 mm ✂ 50 mm	160	110	9,6	20	95	1021	2700 K	9805092920	F
						1050	3000 K	9805093220	
						1140	4000 K	9805093920	
 5 X 2 mm ✂ 50 mm	160	110	14,4	20	90	1426	2700 K	9805142720	F
						1584	3000 K	9805143020	
						1740	4000 K	9805144220	
 5 X 2 mm ✂ 50 mm	160	105	14,4	20	97	1355	2700 K	9805142920	F
						1505	3000 K	9805143220	
						1655	4000 K	9805143920	
 5 X 2 mm ✂ 50 mm	160	105	14,4	20	90	1460	2700 K	98H5142720	F
						1510	3000 K	98H5143020	
						1560	4000 K	98H5144220	

ULTRA SLIM - 24V - L 1cm - IP20



DIMENSIONE E TAGLIO DIMENSION AND CUT	LED/m LED/m	OUTPUT (lm/W)	WATT (W/m)	IP	CRI	LUMEN (lm/m)	CCT CCT	CODICE CODE	RIF. ENERGETICO ENERGY LABEL
 5 X 2 mm ✂ 50 mm	120	85	9,6	20	90	780	2700 K	9805102721	G
 5 X 2 mm ✂ 50 mm	180	85	14,4	20	90	1170	2700 K	9805152721	G
 5 X 2 mm ✂ 50 mm	120	80	9,6	20	95	740	2700 K	9805102921	G
 5 X 2 mm ✂ 50 mm	180	80	14,4	20	95	1110	2700 K	9805152921	G

ULTRA SLIM - 24V - L 1cm - IP20



EXTRA SLIM - ONLY 4,00 mm LARGE

 4 X 2 mm ✂ 33 mm	204	85	14,4	20	90	1175	2700 K	9804152721	G
						1225	3000 K	9804153021	
						1275	4000 K	9804154221	

ULTRA SLIM - 24V - L 1cm - IP54



DIMENSIONE E TAGLIO DIMENSION AND CUT	LED/m LED/m	OUTPUT (lm/W)	WATT (W/m)	IP	CRI	LUMEN (lm/m)	CCT CCT	CODICE CODE	RIF. ENERGETICO ENERGY LABEL
 4 X 2 mm ✂ 30 mm	204	85	14,4	54	90	1175	2700 K	9804152751	G
						1225	3000 K	9804153051	
						1275	4000 K	9804154251	

Temperatura +/- 100 K - 3 step MacAdam / Temperature +/- 100 K - 3 MacAdam steps

ULTRA SLIM - 24V - L 5m - IP20



DIMENSIONE E TAGLIO DIMENSION AND CUT	LED/m LED/m	OUTPUT (lm/W)	WATT (W/m)	IP	CRI	LUMEN (lm/m)	CCT CCT	CODICE CODE	RIF. ENERGETICO ENERGY LABEL
 5 X 2 mm ✂ 50 mm	120	85	9,6	20	90	780	2700 K	9805102720	G
 5 X 2 mm ✂ 50 mm	180	85	14,4	20	90	1170	2700 K	9805152720	G
 5 X 2 mm ✂ 50 mm	120	80	9,6	20	95	740	2700 K	9805102920	G
 5 X 2 mm ✂ 50 mm	180	80	14,4	20	95	1110	2700 K	9805152920	G

ULTRA SLIM - 24V - L 5m - IP20



EXTRA SLIM - ONLY 4,00 mm LARGE

 4 X 2 mm ✂ 30 mm	204	85	14,4	20	90	1175	2700 K	9804152720	G
						1225	3000 K	9804153020	
						1275	4000 K	9804154220	

ULTRA SLIM - 24V - L 5m - IP54



DIMENSIONE E TAGLIO DIMENSION AND CUT	LED/m LED/m	OUTPUT (lm/W)	WATT (W/m)	IP	CRI	LUMEN (lm/m)	CCT CCT	CODICE CODE	RIF. ENERGETICO ENERGY LABEL
 4 X 2 mm ✂ 30 mm	204	85	14,4	54	90	1175	2700 K	9804152754	G
						1225	3000 K	9804153054	
						1275	4000 K	9804154254	

Temperatura +/- 100 K - 3 step MacAdam / Temperature +/- 100 K - 3 MacAdam steps

ULTRA SLIM HE - 24V - L 1cm - IP20



DIMENSIONE E TAGLIO DIMENSION AND CUT	LED/m LED/m	OUTPUT (lm/W)	WATT (W/m)	IP IP	CRI CRI	LUMEN (lm/m)	CCT CCT	CODICE CODE	RIF. ENERGETICO ENERGY LABEL
 5 X 2 mm ✂ 50 mm	168	158	12,0	20	90	1800	2700 K	9805122721	
						1900	3000 K	9805123021	
						2000	4000 K	9805124221	
 5 X 2 mm ✂ 33 mm	180	105	14,4	20	90	1460	2700 K	98H5152721	
						1510	3000 K	98H5153021	
						1560	4000 K	98H5154221	
CRI>97 - R9>90									
 5 X 2 mm ✂ 50 mm	160	135	12,0	20	97	1560	2700 K	9705122921	
						1620	3000 K	9705123221	
						1680	4000 K	9705123921	

ULTRA SLIM HE - 24V - L 5m - IP20



DIMENSIONE E TAGLIO DIMENSION AND CUT	LED/m LED/m	OUTPUT (lm/W)	WATT (W/m)	IP IP	CRI CRI	LUMEN (lm/m)	CCT CCT	CODICE CODE	RIF. ENERGETICO ENERGY LABEL
 5 X 2 mm ✂ 50 mm	168	158	12,0	20	90	1800	2700 K	9805122720	
						1900	3000 K	9805123020	
						2000	4000 K	9805124220	
 5 X 2 mm ✂ 33 mm	180	105	14,4	20	90	1460	2700 K	98H5152720	
						1510	3000 K	98H5153020	
						1560	4000 K	98H5154220	
CRI>97 - R9>90									
 5 X 2 mm ✂ 50 mm	160	135	12,0	20	97	1560	2700 K	9705122920	
						1620	3000 K	9705123220	
						1680	4000 K	9705123920	

ULTRA SLIM HE - 24V - L 1cm - IP54



DIMENSIONE E TAGLIO DIMENSION AND CUT	LED/m LED/m	OUTPUT (lm/W)	WATT (W/m)	IP IP	CRI CRI	LUMEN (lm/m)	CCT CCT	CODICE CODE	RIF. ENERGETICO ENERGY LABEL
 5 X 2 mm ✂ 33 mm	180	105	14,4	54	90	1460	2700 K	98H5152751	
						1510	3000 K	98H5153051	
						1560	4000 K	98H5154251	

ULTRA SLIM HE - 24V - L 5m - IP54



DIMENSIONE E TAGLIO DIMENSION AND CUT	LED/m LED/m	OUTPUT (lm/W)	WATT (W/m)	IP IP	CRI CRI	LUMEN (lm/m)	CCT CCT	CODICE CODE	RIF. ENERGETICO ENERGY LABEL
 5 X 2 mm ✂ 33 mm	180	105	14,4	54	90	1460	2700 K	98H5152754	
						1510	3000 K	98H5153054	
						1560	4000 K	98H5154254	

ULTRA SLIM HE - 24V - L 1cm - IP65



DIMENSIONE E TAGLIO DIMENSION AND CUT	LED/m LED/m	OUTPUT (lm/W)	WATT (W/m)	IP IP	CRI CRI	LUMEN (lm/m)	CCT CCT	CODICE CODE	RIF. ENERGETICO ENERGY LABEL
 5 X 2 mm ✂ 50 mm	168	160	12	65	90	1800	2700 K	9805122761	
						1900	3000 K	9805123061	
						2000	4000 K	9805124261	

ULTRA SLIM HE - 24V - L 5m - IP65



DIMENSIONE E TAGLIO DIMENSION AND CUT	LED/m LED/m	OUTPUT (lm/W)	WATT (W/m)	IP IP	CRI CRI	LUMEN (lm/m)	CCT CCT	CODICE CODE	RIF. ENERGETICO ENERGY LABEL
 5 X 2 mm ✂ 50 mm	168	160	12	65	90	1800	2700 K	9805122765	
						1900	3000 K	9805123065	
						2000	4000 K	9805124265	

Temperatura +/- 100 K - 3 step MacAdam / Temperature +/- 100 K - 3 MacAdam steps

Temperatura +/- 100 K - 3 step MacAdam / Temperature +/- 100 K - 3 MacAdam steps

HIGH EFFICIENT 24V - L 1cm - IP20



DIMENSIONE E TAGLIO DIMENSION AND CUT	LED/m LED/m	OUTPUT (lm/W)	WATT (W/m)	IP	CRI	LUMEN (lm/m)	CCT CCT	CODICE CODE	RIF. ENERGETICO ENERGY LABEL
 10 X 15,5 mm ✂ 40 mm	200	128	11	20	90	1335	2700 K	9824112721	E
						1410	3000 K	9824113021	
						1485	4000 K	9824114221	
 10 X 2 mm ✂ 35 mm	160	110	14,4	20	95	1512	2700 K	9824142921	F
						1590	3000 K	9824143221	
						1649	3500 K	9824143521	
						1740	4000 K	9824143921	
 10 X 2 mm ✂ 35 mm	240	115	14,4	20	95	1540	2700 K	9824162921	F
						1656	3000 K	9824163221	
						1757	4000 K	9824163921	
 10 X 14,5 mm ✂ 72 mm	126	200	14,4	20	90	2856	2700 K	98HE142721	C
						2975	3000 K	98HE143021	
						3094	4000 K	98HE144221	
 10 X 14,5 mm ✂ 50 mm	180	200	19,2	20	90	3680	2700 K	98HE192721	C
						4000	3000 K	98HE193021	
						4160	4000 K	98HE194221	
 10 X 13,6 mm ✂ 50 mm	176	125	24	20	95	2856	2700 K	9824232921	C
						2975	3000 K	9824233221	
						3094	4000 K	9824233921	

HIGH EFFICIENT - 24V - L 1cm - IP20



DIMENSIONE E TAGLIO DIMENSION AND CUT	LED/m LED/m	OUTPUT (lm/W)	WATT (W/m)	IP	CRI	LUMEN (lm/m)	CCT CCT	CODICE CODE	RIF. ENERGETICO ENERGY LABEL
 10 X 2 mm ✂ 50 mm	160	150	12	20	90	1750	2700 K	98HE122721	D
						1800	3000 K	98HE123021	
						1850	4000 K	98HE124221	
 8 X 2 mm ✂ 50 mm	112	150	19,2	20	90	2800	2700 K	98HE202721	D
						2840	3000 K	98HE203021	
						2890	4000 K	98HE204221	
 10 X 2 mm ✂ 33 mm	240	140	21,6	20	90	3025	2700 K	98HE212721	E
						3075	3000 K	98HE213021	
						3125	4000 K	98HE214221	
 10 X 2 mm ✂ 33 mm	240	135	21,6	20	95	2875	2700 K	98HE212921	G
						2920	3000 K	98HE213221	
						2970	4000 K	98HE213921	

Temperatura +/- 100 K - 3 step MacAdam / Temperature +/- 100 K - 3 MacAdam steps

HIGH EFFICIENT 24V - L 5m - IP20



DIMENSIONE E TAGLIO DIMENSION AND CUT	LED/m LED/m	OUTPUT (lm/W)	WATT (W/m)	IP	CRI	LUMEN (lm/m)	CCT CCT	CODICE CODE	RIF. ENERGETICO ENERGY LABEL
 10 X 15,5 mm ✂ 40 mm	200	128	11	20	90	1335	2700 K	9824112720	E
						1410	3000 K	9824113020	
						1485	4000 K	9824114220	
 10 X 2 mm ✂ 35 mm	160	110	14,4	20	95	1512	2700 K	9824142920	F
						1590	3000 K	9824143220	
						1649	3500 K	9824143520	
						1740	4000 K	9824143920	
 10 X 2 mm ✂ 35 mm	240	115	14,4	20	95	1540	2700 K	9824162920	F
						1620	3000 K	9824163220	
						1757	4000 K	9824163920	
 10 X 14,5 mm ✂ 72 mm	126	200	14,4	20	90	2856	2700 K	98HE142720	C
						2975	3000 K	98HE143020	
						3094	4000 K	98HE144220	
 10 X 14,5 mm ✂ 50 mm	180	200	19,2	20	90	3680	2700 K	98HE192720	C
						4000	3000 K	98HE193020	
						4160	4000 K	98HE194220	
 10 X 13,6 mm ✂ 50 mm	240	125	24	20	95	2856	2700 K	9824232920	C
						2975	3000 K	9824233220	
						3094	4000 K	9824233920	











HIGH EFFICIENT - 24V - L 5m - IP20



























DIMENSIONE E TAGLIO DIMENSION AND CUT	LED/m LED/m	OUTPUT (lm/W)	WATT (W/m)	IP	CRI	LUMEN (lm/m)	CCT CCT	CODICE CODE	RIF. ENERGETICO ENERGY LABEL
 10 X 2 mm ✂ 50 mm	160	150	12	20	90	1750	2700 K	98HE122720	D
						1800	3000 K	98HE123020	
						1850	4000 K	98HE124220	
 8 X 2 mm ✂ 50 mm	112	150	19,2	20	90	2800	2700 K	98HE202720	D
						2840	3000 K	98HE203020	
						2890	4000 K	98HE204220	
 10 X 2 mm ✂ 33 mm	240	140	21,6	20	90	3025	2700 K	98HE212720	E
						3075	3000 K	98HE213020	
						3125	4000 K	98HE214220	
 10 X 2 mm ✂ 33 mm	240	135	21,6	20	95	2875	2700 K	98HE212920	G
						2920	3000 K	98HE213220	
						2970	4000 K	98HE213920	

Temperatura +/- 100 K - 3 step MacAdam / Temperature +/- 100 K - 3 MacAdam steps

HIGH EFFICIENT - 24V - L 1cm - IP54

DIMENSIONE E TAGLIO DIMENSION AND CUT	LED/m LED/m	OUTPUT (lm/W)	WATT (W/m)	IP	CRI	LUMEN (lm/m)	CCT CCT	CODICE CODE	RIF. ENERGETICO ENERGY LABEL
 10 X 2 mm ✂ 33 mm	240	135	21,6	54	90	2870 	2700 K	98HE212751	
						2920 	3000 K	98HE213051	
						2970 	4000 K	98HE214251	
 10 X 2 mm ✂ 33 mm	240	128	21,6	54	95	2725 	2700 K	98HE212951	
						2775 	3000 K	98HE213251	
						2820 	4000 K	98HE213951	

HIGH EFFICIENT 24V - L 1cm - IP65

DIMENSIONE E TAGLIO DIMENSION AND CUT	LED/m LED/m	OUTPUT (lm/W)	WATT (W/m)	IP	CRI	LUMEN (lm/m)	CCT CCT	CODICE CODE	RIF. ENERGETICO ENERGY LABEL
 8 X 2 mm ✂ 50 mm	160	115	14,4	65	95	1426 	2700 K	9824142961	
						1584 	3000 K	9824143261	
						1740 	4000 K	9824143961	
 10 X 2 mm ✂ 32 mm	126	200	14,4	65	90	2650 	2700 K	98HE142761	
						2740 	3000 K	98HE143061	
						2880 	4000 K	98HE144261	
 10 X 2 mm ✂ 32 mm	180	200	19,2	65	90	3650 	2700 K	98HE192761	
						3700 	3000 K	98HE193061	
						3840 	4000 K	98HE194261	
 8 X 2 mm ✂ 50 mm	176	125	24	65	95	2856 	2700 K	9824232961	
						2975 	3000 K	9824233261	
						3094 	4000 K	9824233961	
 10 X 2 mm ✂ 32 mm	240	125	33	65	90	3680 	2700 K	98HE322761	
						4000 	3000 K	98HE323061	
						4160 	4000 K	98HE324261	

LAVORAZIONI / PROCESSING

DATI TECNICI TECHNICAL DATA



CABLAGGIO - COLLAUDO - LED IP > 20
INSTALLATION AND TESTING LED >20

CABLAGGIO - COLLAUDO - LED IP > 20 DOPPIA ALIMENTAZIONE
INSTALLATION AND TESTING LED IP>20 POWER SUPPLY











CODICE CODE

98LEDIP

























98LEDIP2

Temperatura +/- 100 K - 3 step MacAdam / Temperature +/- 100 K - 3 MacAdam steps

HIGH EFFICIENT - 24V - L 5m - IP54

DIMENSIONE E TAGLIO DIMENSION AND CUT	LED/m LED/m	OUTPUT (lm/W)	WATT (W/m)	IP	CRI	LUMEN (lm/m)	CCT CCT	CODICE CODE	RIF. ENERGETICO ENERGY LABEL
 10 X 2 mm ✂ 33 mm	240	135	21,6	54	90	2870 	2700 K	98HE212754	
						2920 	3000 K	98HE213054	
						2970 	4000 K	98HE214254	
 10 X 2 mm ✂ 33 mm	240	128	21,6	54	95	2725 	2700 K	98HE212954	
						2775 	3000 K	98HE213254	
						2820 	4000 K	98HE213954	

HIGH EFFICIENT 24V - L 5m - IP65

DIMENSIONE E TAGLIO DIMENSION AND CUT	LED/m LED/m	OUTPUT (lm/W)	WATT (W/m)	IP	CRI	LUMEN (lm/m)	CCT CCT	CODICE CODE	RIF. ENERGETICO ENERGY LABEL
 8 X 2 mm ✂ 50 mm	160	115	14,4	65	95	1426 	2700 K	9824142965	
						1584 	3000 K	9824143265	
						1740 	4000 K	9824143965	
 10 X 2 mm ✂ 32 mm	126	200	14,4	65	90	L = 3m 2650 	2700 K	98HE142765	
						2740 	3000 K	98HE143065	
						2880 	4000 K	98HE144265	
 10 X 2 mm ✂ 32 mm	180	200	19,2	65	90	L = 3m 3650 	2700 K	98HE192765	
						3700 	3000 K	98HE193065	
						3840 	4000 K	98HE194265	
 8 X 2 mm ✂ 50 mm	160	125	24	65	95	2856 	2700 K	9824232965	
						2975 	3000 K	9824233265	
						3094 	4000 K	9824233965	
 10 X 2 mm ✂ 32 mm	240	125	33	65	90	3680 	2700 K	98HE322765	
						4000 	3000 K	98HE323065	
						4160 	4000 K	98HE324265	

Temperatura +/- 100 K - 3 step MacAdam / Temperature +/- 100 K - 3 MacAdam steps

HIGH QUALITY 24V - L 1cm - IP20



DIMENSIONE E TAGLIO DIMENSION AND CUT	LED/m LED/m	OUTPUT (lm/W)	WATT (W/m)	IP IP	CRI CRI	LUMEN (lm/m)	CCT CCT	CODICE CODE	RIF. ENERGETICO ENERGY LABEL
 8 X 2 mm ✂ 32 mm	60	90	14,4	20	95	1250	2700 K	9824152921	
						1280	3000 K	9824153221	
						1300	4000 K	9824153921	
 10 X 2 mm ✂ 25 mm	240	85	19,2	20	90	1560	2700 K	9824202721	
						1640	4000 K	9824204221	
 10 X 2 mm ✂ 50 mm	120	105	24	20	95	2500	2700 K	9824242921	
						2530	3000 K	9824243221	
						2560	4000 K	9824243921	

HIGH QUALITY - 24V - L 1cm - IP65



DIMENSIONE E TAGLIO DIMENSION AND CUT	LED/m LED/m	OUTPUT (lm/W)	WATT (W/m)	IP IP	CRI CRI	LUMEN (lm/m)	CCT CCT	CODICE CODE	RIF. ENERGETICO ENERGY LABEL
 8 X 2 mm ✂ 50 mm	120	80	9,6	65	90	760	2700 K	9824102761	
						770	3000 K	9824103061	
						780	4000 K	9824104261	
 8 X 2 mm ✂ 50 mm	180	80	14,4	65	90	1170	2700 K	9824152761	
						1180	3000 K	9824153061	
						1190	4000 K	9824154261	
 10 X 2 mm ✂ 33 mm	240	80	19,2	65	90	1550	2700 K	9824202761	
						1570	3000 K	9824203061	
						1610	4000 K	9824204261	

LAVORAZIONI / PROCESSING

DATI TECNICI TECHNICAL DATA



CABLAGGIO - COLLAUDO - LED IP > 20
INSTALLATION AND TESTING LED >20

CABLAGGIO - COLLAUDO - LED IP > 20 DOPPIA ALIMENTAZIONE
INSTALLATION AND TESTING LED >20 POWER SUPPLY

CODICE CODE

98LEDIP

98LEDIP2

Temperatura +/- 100 K - 3 step MacAdam / Temperature +/- 100 K - 3 MacAdam steps

HIGH QUALITY 24V - L 5m - IP20



DIMENSIONE E TAGLIO DIMENSION AND CUT	LED/m LED/m	OUTPUT (lm/W)	WATT (W/m)	IP IP	CRI CRI	LUMEN (lm/m)	CCT CCT	CODICE CODE	RIF. ENERGETICO ENERGY LABEL
 8 X 2 mm ✂ 32 mm	60	90	14,4	20	95	1250	2700 K	9824152920	
						1280	3000 K	9824153220	
						1300	4000 K	9824153920	
 10 X 2 mm ✂ 25 mm	240	85	19,2	20	90	1560	2700 K	9824202720	
						1640	4000 K	9824204220	
 10 X 2 mm ✂ 50 mm	120	105	24	20	95	2500	2700 K	9824242920	
						2530	3000 K	9824243220	
						2560	4000 K	9824243920	

HIGH QUALITY - 24V - L 5m - IP65



DIMENSIONE E TAGLIO DIMENSION AND CUT	LED/m LED/m	OUTPUT (lm/W)	WATT (W/m)	IP IP	CRI CRI	LUMEN (lm/m)	CCT CCT	CODICE CODE	RIF. ENERGETICO ENERGY LABEL
 8 X 2 mm ✂ 50 mm	120	80	9,6	65	90	760	2700 K	9824102765	
						770	3000 K	9824103065	
						780	4000 K	9824104265	
 8 X 2 mm ✂ 50 mm	180	80	14,4	65	90	1170	2700 K	9824152765	
						1180	3000 K	9824153065	
						1190	4000 K	9824154265	
 10 X 2 mm ✂ 33 mm	240	80	19,2	65	90	1550	2700 K	9824202765	
						1570	3000 K	9824203065	
						1610	4000 K	9824204265	

Temperatura +/- 100 K - 3 step MacAdam / Temperature +/- 100 K - 3 MacAdam steps

HIGH OUT PUT 24V - L 1cm - IP65



DIMENSIONE E TAGLIO DIMENSION AND CUT	LED/m LED/m	OUTPUT (lm/W)	WATT (W/m)	IP IP	CRI CRI	LUMEN (lm/m)	CCT CCT	CODICE CODE	RIF. ENERGETICO ENERGY LABEL
 8 X 2 mm ✂ 50 mm	128	120	12,3	65	90	1400	2700 K	98HO122761	F
						1470	3000 K	98HO123061	
						1530	4000 K	98HO124261	
 10 X 2 mm ✂ 33 mm	280	105	20	65	90	2100	2700 K	98HO202761	F
						2200	3000 K	98HO203061	
						2350	4000 K	98HO204261	
 10 X 2 mm ✂ 50 mm	120	105	24	65	95	2500	2700 K	9824242961	F
						2530	3000 K	9824243261	
						2560	4000 K	9824243961	

HIGH OUT PUT 24V - L 5m - IP65



DIMENSIONE E TAGLIO DIMENSION AND CUT	LED/m LED/m	OUTPUT (lm/W)	WATT (W/m)	IP IP	CRI CRI	LUMEN (lm/m)	CCT CCT	CODICE CODE	RIF. ENERGETICO ENERGY LABEL
 8 X 2 mm ✂ 50 mm	128	120	12,3	65	90	1400	2700 K	98HO122765	F
						1470	3000 K	98HO123065	
						1530	4000 K	98HO124265	
 10 X 2 mm ✂ 33 mm	280	105	20	65	90	2100	2700 K	98HO202765	F
						2200	3000 K	98HO203065	
						2350	4000 K	98HO204265	
 10 X 2 mm ✂ 50 mm	120	105	24	65	95	2500	2700 K	9824242965	F
						2530	3000 K	9824243265	
						2560	4000 K	9824243965	

LOW POWER - 24V - L 1cm - IP20



DIMENSIONE E TAGLIO DIMENSION AND CUT	LED/m LED/m	OUTPUT (lm/W)	WATT (W/m)	IP IP	CRI CRI	LUMEN (lm/m)	CCT CCT	CODICE CODE	RIF. ENERGETICO ENERGY LABEL
 10 X 2 mm ✂ 50 mm	140	100	6	20	90	770	2700 K	9824LP2721	E
						800	3000 K	9824LP3021	
						840	4000 K	9824LP4221	

LOW POWER - 24V - L 5m - IP20



DIMENSIONE E TAGLIO DIMENSION AND CUT	LED/m LED/m	OUTPUT (lm/W)	WATT (W/m)	IP IP	CRI CRI	LUMEN (lm/m)	CCT CCT	CODICE CODE	RIF. ENERGETICO ENERGY LABEL
 10 X 2 mm ✂ 50 mm	140	100	6	20	90	770	2700 K	9824LP2720	E
						800	3000 K	9824LP3020	
						840	4000 K	9824LP4220	

LOW POWER - 24V - L 1cm - IP65



DIMENSIONE E TAGLIO DIMENSION AND CUT	LED/m LED/m	OUTPUT (lm/W)	WATT (W/m)	IP IP	CRI CRI	LUMEN (lm/m)	CCT CCT	CODICE CODE	RIF. ENERGETICO ENERGY LABEL
 10 X 2 mm ✂ 50 mm	140	95	6	65	90	540	2700 K	98LP062761	E
						570	3000 K	98LP063061	
						600	4000 K	98LP064261	

LOW POWER - 24V - L 5m - IP65



DIMENSIONE E TAGLIO DIMENSION AND CUT	LED/m LED/m	OUTPUT (lm/W)	WATT (W/m)	IP IP	CRI CRI	LUMEN (lm/m)	CCT CCT	CODICE CODE	RIF. ENERGETICO ENERGY LABEL
 10 X 2 mm ✂ 50 mm	140	95	6	65	90	540	2700 K	98LP062765	E
						570	3000 K	98LP063065	
						600	4000 K	98LP064265	

Temperatura +/- 100 K - 3 step MacAdam / Temperature +/- 100 K - 3 MacAdam steps

Temperatura +/- 100 K - 3 step MacAdam / Temperature +/- 100 K - 3 MacAdam steps

HIGH OUTPUT - 24V - L 1cm - IP20



DIMENSIONE E TAGLIO DIMENSION AND CUT	LED/m LED/m	OUTPUT (lm/W)	WATT (W/m)	IP IP	CRI CRI	LUMEN (lm/m)	CCT CCT	CODICE CODE	RIF. ENERGETICO ENERGY LABEL
 10 X 2 mm ✂ 63 mm	128	115	12,3	20	90	1350	2700 K	98HO122721	
						1400	3000 K	98HO123021	
						1450	4000 K	98HO124221	
 8 X 2 mm ✂ 34 mm	180	105	14,4	20	95	1500	2700 K	98HO152921	
						1550	3000 K	98HO153221	
						1590	4000 K	98HO153921	
 9 X 2 mm ✂ 25 mm	240	110	19,2	20	95	2050	2700 K	98HO202921	
						2100	3000 K	98HO203221	
						2200	4000 K	98HO203921	
 10 X 2 mm ✂ 32 mm	240	105	24	20	95	2500	2700 K	98HO242921	
						2530	3000 K	98HO243221	
						2560	4000 K	98HO243921	
 10 X 2 mm ✂ 33 mm	240	100	20	20	97	2000	2700 K	97HO202921	
						2050	3000 K	97HO203221	
						2100	4000 K	97HO203921	

24V - 2500 K - L 1cm - IP20



DIMENSIONE E TAGLIO DIMENSION AND CUT	LED/m LED/m	OUTPUT (lm/W)	WATT (W/m)	IP IP	CRI CRI	LUMEN (lm/m)	CCT CCT	CODICE CODE	RIF. ENERGETICO ENERGY LABEL
 10 X 2 mm ✂ 50 mm	240	77	19,2	20	90	1470	2500 K	98HO202621	

Temperatura +/- 100 K - 3 step MacAdam / Temperature +/- 100 K - 3 MacAdam steps

HIGH INTENSITY - 24V - L 1cm - IP20



DIMENSIONE E TAGLIO DIMENSION AND CUT	LED/m LED/m	OUTPUT (lm/W)	WATT (W/m)	IP IP	CRI CRI	LUMEN (lm/m)	CCT CCT	CODICE CODE	RIF. ENERGETICO ENERGY LABEL
 10 X 2 mm ✂ 25 mm	280	90	24	20	90	2110	2700 K	98HI242721	
						2160	3000 K	98HI243021	
						2210	4000 K	98HI244221	

HIGH OUTPUT - 24V - L 5m - IP20



DIMENSIONE E TAGLIO DIMENSION AND CUT	LED/m LED/m	OUTPUT (lm/W)	WATT (W/m)	IP IP	CRI CRI	LUMEN (lm/m)	CCT CCT	CODICE CODE	RIF. ENERGETICO ENERGY LABEL
 10 X 2 mm ✂ 63 mm	128	115	12,3	20	90	1350	2700 K	98HO122720	
						1400	3000 K	98HO123020	
						1450	4000 K	98HO124220	
 8 X 2 mm ✂ 34 mm	180	105	14,4	20	95	1500	2700 K	98HO152920	
						1550	3000 K	98HO153220	
						1590	4000 K	98HO153920	
 9 X 2 mm ✂ 25 mm	240	110	19,2	20	95	2050	2700 K	98HO202920	
						2100	3000 K	98HO203220	
						2200	4000 K	98HO203920	
 10 X 2 mm ✂ 32 mm	240	105	24	20	95	2500	2700 K	98HO242920	
						2530	3000 K	98HO243220	
						2560	4000 K	98HO243920	
 10 X 2 mm ✂ 33 mm	240	100	20	20	97	2000	2700 K	97HO202920	
						2050	3000 K	97HO203220	
						2100	4000 K	97HO203920	

24V - 2500 K - L 5cm - IP20



DIMENSIONE E TAGLIO DIMENSION AND CUT	LED/m LED/m	OUTPUT (lm/W)	WATT (W/m)	IP IP	CRI CRI	LUMEN (lm/m)	CCT CCT	CODICE CODE	RIF. ENERGETICO ENERGY LABEL
 10 X 2 mm ✂ 50 mm	240	77	19,2	20	90	1470	2500 K	98HO202620	

Temperatura +/- 100 K - 3 step MacAdam / Temperature +/- 100 K - 3 MacAdam steps

HIGH INTENSITY - 24V - L 5m - IP20



DIMENSIONE E TAGLIO DIMENSION AND CUT	LED/m LED/m	OUTPUT (lm/W)	WATT (W/m)	IP IP	CRI CRI	LUMEN (lm/m)	CCT CCT	CODICE CODE	RIF. ENERGETICO ENERGY LABEL
 10 X 2 mm ✂ 25 mm	280	90	24	20	90	2110	2700 K	98HI242720	
						2160	3000 K	98HI243020	
						2210	4000 K	98HI244220	

led rgb
rgb ultraslim
led rgbw
led rgbtw
led tw

“cambiano colore a piacere dell'utenza”

RGB è l'acronimo inglese dei colori primari Red, Green, Blue, usati nei led per formare le varie tonalità di colore. A differenza dei led monocromatici, che emettono un solo colore (in genere il Bianco), i led RGB hanno la possibilità cambiare colore a piacere dell'utente con la frequenza decisa dallo stesso. Grazie a questa tecnologia, ogni ambiente potrà essere valorizzato al meglio con spettacolari giochi di luce, permettendo di creare una luce calda, morbida e diffusa, ma soprattutto di donare personalità anche al più impersonale degli spazi.

RGB is the English acronym for the primary colors Red, Green, Blue, used in the LEDs to form the various shades of color. Unlike monochromatic LEDs, which emit only one color (usually White), RGB LEDs have the ability to change color as desired by the user with the frequency decided by the user. Thanks to this technology, every environment can be enhanced to the best with spectacular plays of light, allowing you to create a warm, soft and diffused light, but above all to give personality to even the most impersonal of spaces.

led rgb + rgbw

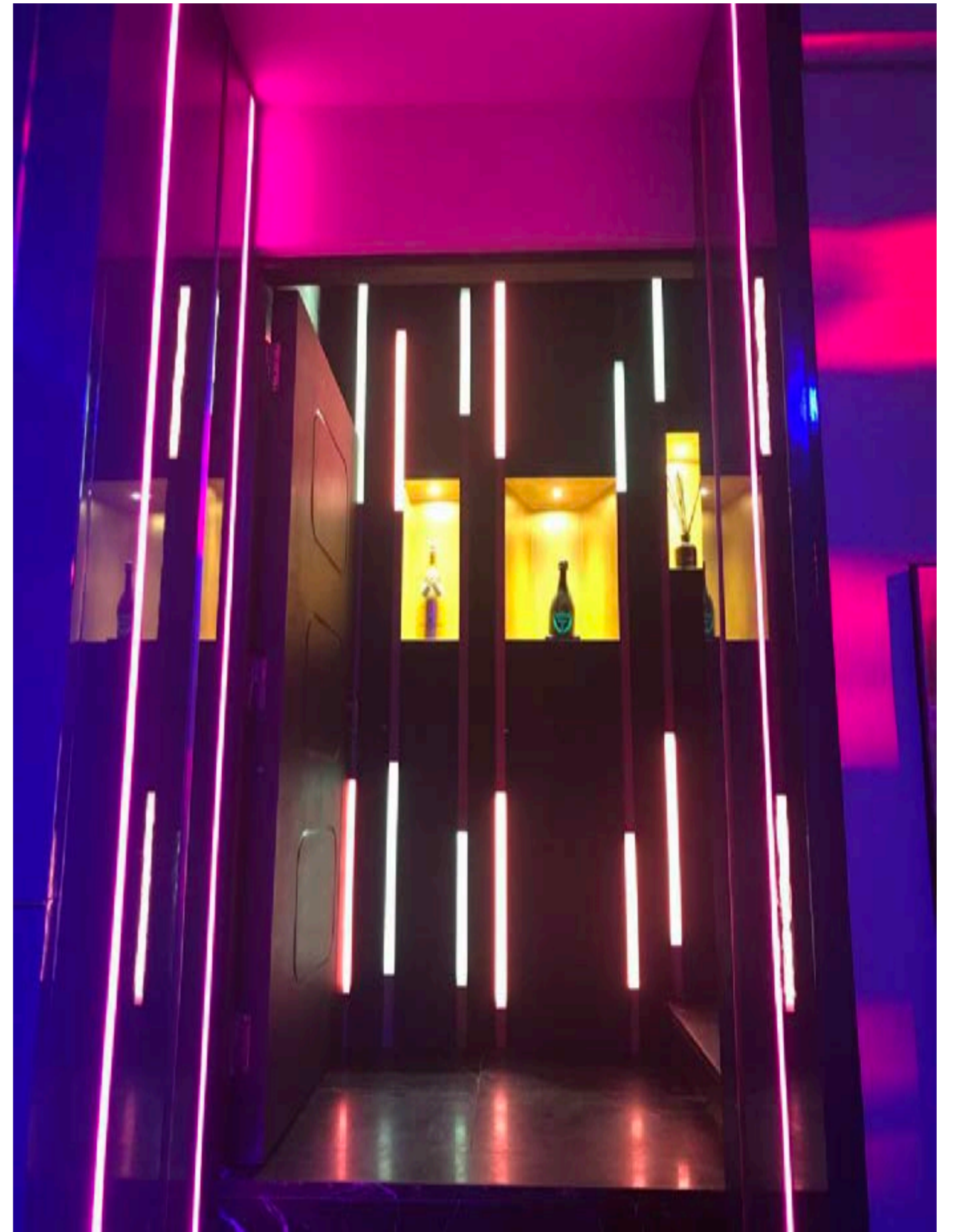

led new generation rgb

LED RGB - L 1cm - IP20



DIMENSIONE E TAGLIO DIMENSION AND CUT	LED/m LED/m	WATT (W/m)	IP	LUMEN (lm/m)	CCT CCT	CODICE CODE
 10 X 2 mm ✂ 100 mm	336	14,4	20	960	RED GREEN BLUE	9924150021
 10 X 2 mm ✂ 100 mm	60	14,4	20	960	RED GREEN BLUE	9924159921

LED RGB - L 1cm - IP65



DIMENSIONE E TAGLIO DIMENSION AND CUT	LED/m LED/m	WATT (W/m)	IP	LUMEN (lm/m)	CCT CCT	CODICE CODE
 10 X 2 mm ✂ 100 mm	60	14,4	65	960	RED GREEN BLUE	9924159961



LED RGB - L 5m - IP20



DIMENSIONE E TAGLIO DIMENSION AND CUT	LED/m LED/m	WATT (W/m)	IP	LUMEN (lm/m)	CCT CCT	CODICE CODE
 10 X 2 mm ✂ 100 mm	336	14,4	20	960	RED GREEN BLUE	9924150020
 10 X 2 mm ✂ 100 mm	60	14,4	20	960	RED GREEN BLUE	9924159920

LED RGB - L 5m - IP65



DIMENSIONE E TAGLIO DIMENSION AND CUT	LED/m LED/m	WATT (W/m)	IP	LUMEN (lm/m)	CCT CCT	CODICE CODE
 10 X 2 mm ✂ 100 mm	60	14,4	65	960	RED GREEN BLUE	9924159960

led new generation rgb ultraslim

LED RGB ULTRASLIM - L 1cm - IP20



DIMENSIONE E TAGLIO DIMENSION AND CUT	LED/m LED/m	WATT (W/m)	IP	LUMEN (lm/m)	CCT CCT	CODICE CODE
 5 X 2 mm ✂ 50 mm	120	12	20	515	RED GREEN BLUE	9905129921

LED RGB ULTRASLIM - L 1cm - IP54



DIMENSIONE E TAGLIO DIMENSION AND CUT	LED/m LED/m	WATT (W/m)	IP	LUMEN (lm/m)	CCT CCT	CODICE CODE
 5 X 2 mm ✂ 50 mm	120	12	54	515	RED GREEN BLUE	9905129951

LED RGB ULTRASLIM - L 5m - IP20



DIMENSIONE E TAGLIO DIMENSION AND CUT	LED/m LED/m	WATT (W/m)	IP	LUMEN (lm/m)	CCT CCT	CODICE CODE
 5 X 2 mm ✂ 50 mm	120	12	20	515	RED GREEN BLUE	9905129920

LED RGB ULTRASLIM - L 5m - IP54



DIMENSIONE E TAGLIO DIMENSION AND CUT	LED/m LED/m	WATT (W/m)	IP	LUMEN (lm/m)	CCT CCT	CODICE CODE
 5 X 2 mm ✂ 50 mm	120	12	54	515	RED GREEN BLUE	9905129954

LAVORAZIONI / PROCESSING

DATI TECNICI
TECHNICAL DATA

CODICE
CODE



CABLAGGIO - COLLAUDO - LED IP > 20
INSTALLATION AND TESTING LED >20

98RGBIP

CABLAGGIO - COLLAUDO - LED IP > 20 DOPPIA ALIMENTAZIONE
INSTALLATION AND TESTING LED IP>20 POWER SUPPLY

98RGBIP2

led rgbw

LED RGBW - L 1cm - IP20



DIMENSIONE E TAGLIO DIMENSION AND CUT	LED/m LED/m	WATT (W/m)	IP IP	LUMEN (lm/m)	CCT CCT	CODICE CODE
 10 X 2,5 mm ✂ 100 mm	60	14,4	20	880	RED GREEN BLUE 3000K - 3200K	9924159021
 12 X 2 mm ✂ 84 mm	96	23	20	1390	RED GREEN BLUE 3000K - 3200K	9924239021

LED RGBW - L 1cm - IP65



DIMENSIONE E TAGLIO DIMENSION AND CUT	LED/m LED/m	WATT (W/m)	IP IP	LUMEN (lm/m)	CCT CCT	CODICE CODE
 12 X 2,5 mm ✂ 166 mm	60	14,4	65	880	RED GREEN BLUE 3000K - 3200K	9924159061
 12 X 2 mm ✂ 84 mm	96	23	65	1390	RED GREEN BLUE 3000K - 3200K	9924239061

LED RGB TUNABLE WHITE - L 1cm - IP20



DIMENSIONE E TAGLIO DIMENSION AND CUT	LED/m LED/m	WATT (W/m)	IP IP	CRI CRI	LUMEN (lm/m)	CCT CCT	CODICE CODE
 18 X 2,5 mm ✂ 100 mm	60	18	20	90	1200	RED GREEN BLUE 2700 K ↓ 6000* K	9924189021

led rgbw

LED RGBW - L 5m - IP20



DIMENSIONE E TAGLIO DIMENSION AND CUT	LED/m LED/m	WATT (W/m)	IP IP	LUMEN (lm/m)	CCT CCT	CODICE CODE
 10 X 2,5 mm ✂ 100 mm	60	14,4	20	880	RED GREEN BLUE 3000K - 3200K	9924159020
 12 X 2 mm ✂ 84 mm	96	23	20	1390	RED GREEN BLUE 3000K - 3200K	9924239020

LED RGBW - L 5m - IP65



DIMENSIONE E TAGLIO DIMENSION AND CUT	LED/m LED/m	WATT (W/m)	IP IP	LUMEN (lm/m)	CCT CCT	CODICE CODE
 12 X 2,5 mm ✂ 166 mm	60	14,4	65	880	RED GREEN BLUE 3000K - 3200K	9924159065
 12 X 2 mm ✂ 84 mm	96	23	65	1390	RED GREEN BLUE 3000K - 3200K	9924239065

LED RGB TUNABLE WHITE - L 5m - IP20





DIMENSIONE E TAGLIO DIMENSION AND CUT	LED/m LED/m	WATT (W/m)	IP IP	LUMEN (lm/m)	CCT CCT	CODICE CODE
 18 X 2,5 mm ✂ 100 mm	60	18	20	1200	RED GREEN BLUE 2700 K ↓ 6000* K	9924189020

LAVORAZIONI / PROCESSING

DATI TECNICI TECHNICAL DATA	CODICE CODE
CABLAGGIO - COLLAUDO - LED IP > 20 INSTALLATION AND TESTING LED >20	98RGBIP
CABLAGGIO - COLLAUDO - LED IP > 20 DOPPIA ALIMENTAZIONE INSTALLATION AND TESTING LED IP>20 POWER SUPPLY	98RGBIP2



LED TUNABLE WHITE - L 5m - IP20



DIMENSIONE E TAGLIO DIMENSION AND CUT	LED/m LED/m	WATT (W/m)	IP	CRI	LUMEN (lm/m)	CCT CCT	CODICE CODE	RIF. ENERGETICO ENERGY LABEL
 10 X 2 mm ✂ 50 mm	240	24	20		2000	1800 K ↓ 5000 K	9924246220	G
 10 X 2 mm ✂ 50 mm	240	30	20		2800	1800 K ↓ 5000 K	9924306220	G

LED TUNABLE WHITE - L 1cm - IP20



DIMENSIONE E TAGLIO DIMENSION AND CUT	LED/m LED/m	WATT (W/m)	IP	CRI	LUMEN (lm/m)	CCT CCT	CODICE CODE	RIF. ENERGETICO ENERGY LABEL
 10 X 2 mm ✂ 50 mm	240	24	20		2000	1800 K ↓ 5000 K	9924246221	G
 10 X 2 mm ✂ 50 mm	240	30	20		3480	1800 K ↓ 5000 K	9924306221	F

SLIM LED TUNABLE WHITE - L 1cm - IP20

NEW



DIMENSIONE E TAGLIO DIMENSION AND CUT	LED/m LED/m	WATT (W/m)	IP	CRI	LUMEN (lm/m)	CCT CCT	CODICE CODE	RIF. ENERGETICO ENERGY LABEL
 5 X 2 mm ✂ 50 mm	320	14,4	20		1584	1800 K ↓ 5000 K	9905146221	F

SLIM LED TUNABLE WHITE - L 5m - IP20

NEW



DIMENSIONE E TAGLIO DIMENSION AND CUT	LED/m LED/m	WATT (W/m)	IP	CRI	LUMEN (lm/m)	CCT CCT	CODICE CODE	RIF. ENERGETICO ENERGY LABEL
 5 X 2 mm ✂ 50 mm	320	14,4	20		1584	1800 K ↓ 5000 K	9905146220	F

SLIM LED TUNABLE WHITE - L 1cm - IP54

NEW



DIMENSIONE E TAGLIO DIMENSION AND CUT	LED/m LED/m	WATT (W/m)	IP	CRI	LUMEN (lm/m)	CCT CCT	CODICE CODE	RIF. ENERGETICO ENERGY LABEL
 5 X 2 mm ✂ 50 mm	320	14,4	20		1584	1800 K ↓ 5000 K	9905146251	F

SLIM LED TUNABLE WHITE - L 5m - IP54

NEW



DIMENSIONE E TAGLIO DIMENSION AND CUT	LED/m LED/m	WATT (W/m)	IP	CRI	LUMEN (lm/m)	CCT CCT	CODICE CODE	RIF. ENERGETICO ENERGY LABEL
 5 X 2 mm ✂ 50 mm	320	14,4	20		1584	1800 K ↓ 5000 K	9905146254	F



ACCESSORI / ACCESSORIES

CONTROLLER TOUCH + CENTRALINA / CONTROLLER TOUCH RGB + REMOTE CONTROL

DATI TECNICI TECHNICAL DATA	POTENZA MASSIMA SUPPORTATA SUPPORTED MAX POWER	CODICE CODE
DIMENSIONI / DIMENSIONS: 83 x 82 x 32 mm GRADO DI PROTEZIONE / PROTECTION DEGREE: IP20	LED RGB 432	9924010001
ARTICOLI INCLUSI NEL CODICE: ARTICLES INCLUDED IN THE CODE: - Centralina / Remote control - Controller touch RGB	LED RGBW 576	9924010003
	LED RGBTW 480	9924114000



N.B. CENTRALINA DA ABBINARE AD UN DRIVER ON/OFF

driver 24V ip20

DATI TECNICI TECHNICAL DATA

Tensione/Voltage: 24V - CC SELV / 220-240v - 50-60 Hz
 Power Factor > 0.9 at > 50% load
 DC Operation 176-264v DC
 Ambient Temperature: -15°C to 60°C
 Weight: 0.20 - 1.50 Kg

DIMENSIONI (ln x lg x h) DIMENSIONS	POTENZA POWER	CODICE CODE	PREZZO PRICE
	13 W	980132	
	20 W	980202	
	30 W	980302	
	75 W	980752	
	90 W	980902	
	120 W	981202	
	180 W 200 W	981802 982002	

DRIVER ON/OFF SLIM NEW

DATI TECNICI TECHNICAL DATA

Tensione/Voltage: 24V - CC SELV / 220-240v - 50-60 Hz
 Power Factor > 0.9 at > 50% load
 DC Operation 176-264v DC
 Ambient Temperature: -15°C to 60°C
 Weight: 0.20 - 1.50 Kg

DIMENSIONI (ln x lg x h) DIMENSIONS	POTENZA POWER	CODICE CODE
	30 W	98030L
	60 W	98060L
	100 W	98100L
	150 W	98150L
	250 W	98250L

driver mA ip20

DATI TECNICI TECHNICAL DATA

Corrente: 700 mA - CC SELV / 220-240v - 50-60 Hz
 Power Factor > 0.96 at
 Operation 176-264v DC
 Ambient Temperature: -15°C to 60°C
 Weight: 0.20 - 1.50 Kg

DIMENSIONI (ln x lg x h) DIMENSIONS	POTENZA POWER	CODICE CODE
	10 W	980107
	15 W	980157
	32 W	980327

driver ip67

DATI TECNICI TECHNICAL DATA

Tensione/Voltage: 24V - CC SELV / 220-240v - 50-60 Hz
 Power Factor > 0.9 at > 50% load
 DC Operation 176-264v DC
 Ambient Temperature: -15°C to 60°C
 Weight: 0.20 - 1.50 Kg

DIMENSIONI (ln x lg x h) DIMENSIONS	POTENZA POWER	CODICE CODE
	30 W	980306
	75 W	980756
	100 W	981006
	150 W	981506
	200 W	982006
	240 W	982406
	320 W	983206
	480 W	9848D6
	600 W	9860D6
	600 W	9860D6

emergency driver

KIT DI EMERGENZA / EMERGENCY LIGHT KIT

DATI TECNICI TECHNICAL DATA	DIMENSIONI (ln x lg x h)mm DIMENSIONS	CODICE CODE
VOLTAGE: 220-240V FREQUENCY: 50/60 Hz POWER: 30 W SUPPLY CURRENT: 20 mA OPERATING TIME: 1-3 h CHARGE TIME: 24 h ta °C: 0 / +60 tc °C: 80		983010

SCHEMA DI COLLEGAMENTO / WIRING DIAGRAM

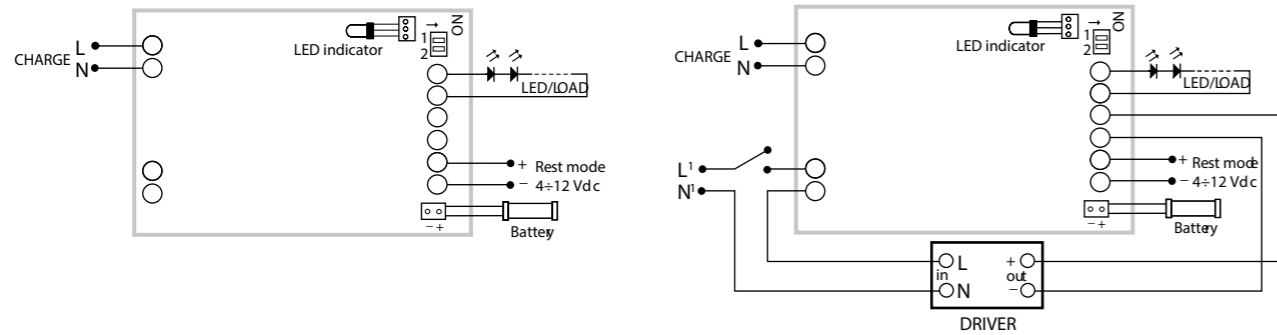

DIMMER

DATI TECNICI TECHNICAL DATA	DIMENSIONI (ln x lg x h) DIMENSIONS	POTENZA POWER	CODICE CODE
DIMMER 0-10 V 12-24V - 8A		200 W	98200V
DIMMER DALI PUSH / 1-10 V - 5A		120 W	98120D

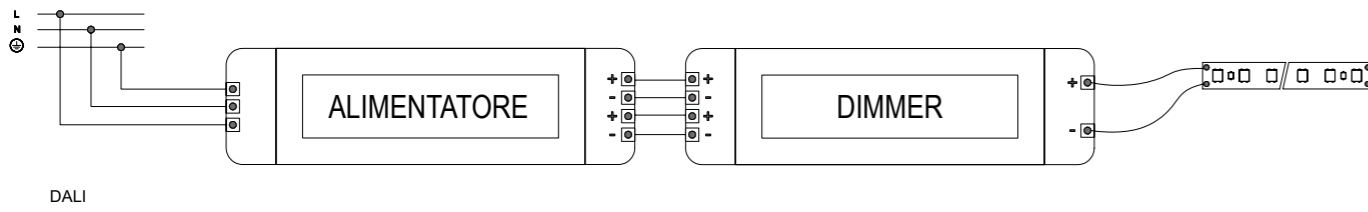

The PUSH dimming wiring diagram

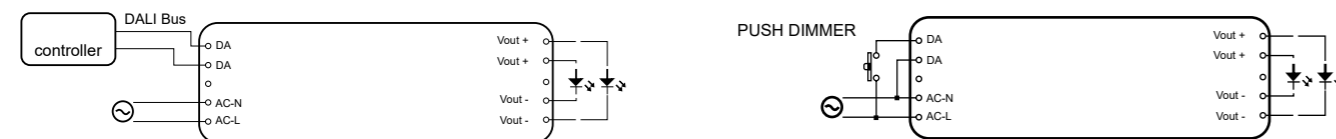

PUSH DIMMER

dimmer

DRIVER DIMMER DALI / SWITCH PUSH

DATI TECNICI TECHNICAL DATA	DIMENSIONI (ln x lg x h) DIMENSIONS	POTENZA POWER	CODICE CODE
Tensione / Voltage: 24V - CC SELV / 220-240v - 50-60 Hz Dimmer da 1 a 100% Power Factor > 0.9 at > 50% load Ambient Temperature: -40°C to 80°C AC Voltage range 198-264v DC Voltage range 178-280v Weight: 0.30 - 0.80 Kg		35 W	98035D
		60 W	98060D
		100 W	98100D
		150 W	98150D

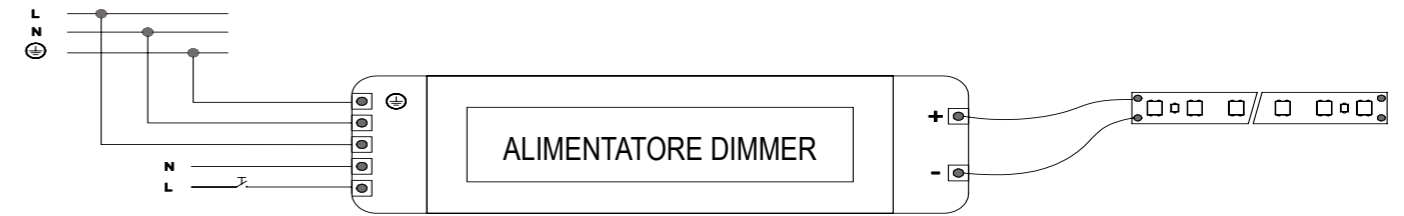

DRIVER DIMMER DALI/SWITCH PUSH SLIM NEW

DATI TECNICI TECHNICAL DATA	DIMENSIONI (ln x lg x h) DIMENSIONS	POTENZA POWER	CODICE CODE
Tensione / Voltage: 24V - CC SELV / 220-240v - 50-60 Hz Dimmer da 1 a 100% Power Factor > 0.9 at > 50% load Ambient Temperature: -40°C to 80°C AC Voltage range 198-264v DC Voltage range 178-280v Weight: 0.30 - 0.80 Kg		12 W	98012D
		30 W	98031D
		60 W	98061D
		100 W	98101D
		150 W	98151D
		250 W	98251D

Dimming connection diagram

The DALI wiring diagram

light control monocolor rgb/w - tw

ALIMENTATORE KNX 640mA 30V DC

DATI TECNICI TECHNICAL DATA	DIMENSIONI (ln x lg x h) DIMENSIONS	CODICE CODE
TENSIONE D'ESERCIZIO: 230 V AC - 240 V AC, 50 Hz - 60 Hz INSTALLAZIONE: MONTAGGIO SU BARRA DIN 4 MODULI TENSIONE NOMINALE: KNX 30V DC, 2V, SELV GRADO DI PROTEZIONE: IP20	71,85 x 90 x 65,5 mm	9070958



ATTUATORE DI COMMUTAZIONE

DATI TECNICI TECHNICAL DATA	DIMENSIONI (ln x lg x h) DIMENSIONS	CANALI CHANNELS	CODICE CODE
TENSIONE D'ESERCIZIO: 110 V AC - 240 V AC, 50 Hz - 60 Hz INSTALLAZIONE: MONTAGGIO SU BARRA DIN 4 MODULI POTENZA COMMUTAZIONE MAX: 3680 W GRADO DI PROTEZIONE: IP20	35 x 70 x 65 mm	8	4940220

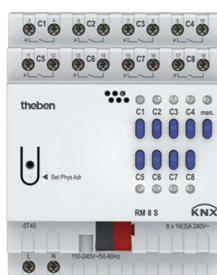

WEB SERVER KNX

DATI TECNICI TECHNICAL DATA	DIMENSIONI (ln x lg x h) DIMENSIONS	CODICE CODE	PREZZO PRICE
TENSIONE D'ESERCIZIO: 12 V AC - 24 V AC, 50 Hz - 60 Hz ASSORBIMENTO: 3 W (240 mA a 12 V) GRADO DI PROTEZIONE: IP20 CLASSE DI ISOLAMENTO: II	89 x 98 x 62 mm	IKON200	
	89 x 98 x 62 mm	IKON400	



DALI-GATEWAY KNX

DATI TECNICI TECHNICAL DATA	DIMENSIONI (ln x lg x h) DIMENSIONS	CANALI CHANNELS	CODICE CODE
TENSIONE D'ESERCIZIO: 100 V AC - 240 V AC/DC, 50 Hz - 60 Hz INSTALLAZIONE: MONTAGGIO SU BARRA DIN 4 MODULI GRADO DI PROTEZIONE: IP20	35 x 70 x 65 mm	1	4940301
	35 x 70 x 65 mm	2	4940302

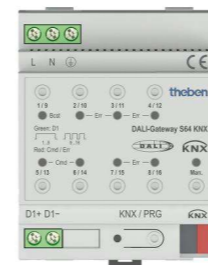

INTERFACCE TASTI INGRESSO BINARIO/USCITA BINARIA

DATI TECNICI TECHNICAL DATA	DIMENSIONI (ln x lg x h) DIMENSIONS	CANALI CHANNELS	CODICE CODE
TENSIONE D'ESERCIZIO: KNX, Bus ≤10 mA GRADO DI PROTEZIONE: IP20 CLASSE DI ISOLAMENTO: III		2	4969222
		4	4969224
	37,3 x 38 x 12,4 mm	6	4969226
		8	4969228



ESEMPIO DI GESTION IKON SERVER DI UN IMPIANTO DOMOTICO

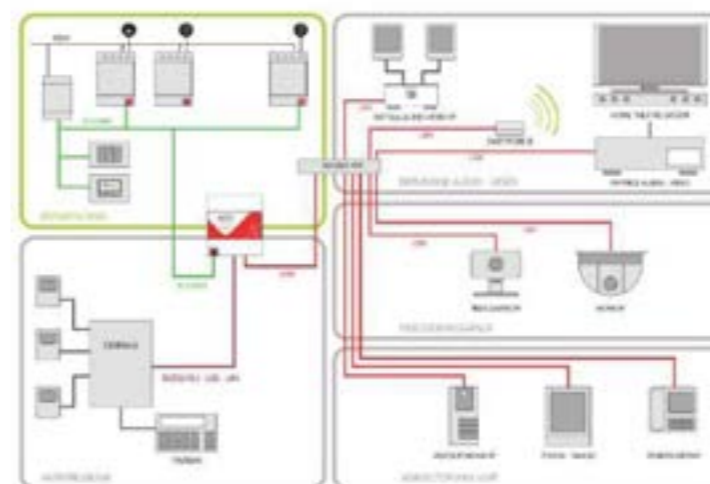

condizioni di vendita

Il committente accetta, nessuna esclusa, tutte le condizioni di vendita sotto indicate all'atto stesso in cui conferisce l'ordine anche se non esplicitamente dichiarata.

La presente pubblicazione annulla e sostituisce tutte le precedenti.

DESIGN LUCE SRLU si riserva la facoltà di sopprimere o apportare ai propri apparecchi ed accessori qualsiasi modifica che ritiene necessaria ai fini tecnici e commerciali o estetici senza darne preavviso. Le descrizioni e le dimensioni degli apparecchi riportate nei cataloghi e listini sono indicativi e non impegnativi.

ORDINI - CONFERME - TRASPORTO

Gli ordini dovranno essere trasmessi per iscritto da parte del committente o dai rappresentanti regolarmente nominati dalla DESIGN LUCE SRLU. Gli ordini telefonici dovranno essere confermati per iscritto, su carta intestata, da inviare all'apposito indirizzo mail.

La DESIGN LUCE SRLU si riserva il diritto di richiedere un anticipo sul pagamento totale della fornitura.

Per importi superiori a € 500,00 non saranno addebitate le spese di spedizione. Per ordini inferiori a € 500,00 sarà effettuata la consegna in porto franco con addebito di € 16,00. Per articoli con ingombri superiori ai 2,00m saranno addebitati ulteriori € 10,00.

Per gli articoli che richiedono imballi speciali in legno sarà previsto un addebito minimo di € 15,00 che sarà comunicato in conferma d'ordine. I termini di consegna saranno puramente indicativi. Il committente dovrà fornire i dati necessari e aver adempiuto a tutti gli obblighi nei confronti del fornitore nessuno escluso per permettere alla DESIGN LUCE SRLU di attivare le procedure interne ed emettere la conferma d'ordine con la data presunta di partenza della merce dagli stabilimenti. La DESIGN LUCE SRLU non accetta in nessun modo e per conto di nessuno ordini con consegna tassativa. I ritardi nelle consegne non danno diritto al committente a nessun risarcimento nè concede la facoltà parziale o totale di annullare, risolvere, rescindere il contratto d'acquisto. La merce viaggia sempre a rischio e pericolo del committente, indipendentemente dalle condizioni di resa. La DESIGN LUCE SRLU non risarcirà il committente per materiale danneggiato, rubato o manomesso durante il trasporto.

Il committente è tenuto alla verifica quantitativa

e qualitativa della merce all'atto della consegna ed è tenuto ad accettare sempre con RISERVA. I prezzi indicati nel presente listino sono al pubblico IVA ESCLUSA e potranno essere cambiati in qualsiasi momento dalla DESIGN LUCE SRLU che confermerà i prezzi indicati sull'ordine mediante conferma d'ordine inviata al committente.

RESI DI MATERIALE

I resi del materiale, inclusi quelli per merce difettosa in garanzia, dovranno essere preventivamente concordati per iscritto con la DESIGN LUCE SRLU che non accetterà materiale senza autorizzazione. Questo sarà respinto dal nostro reparto preposto. Il materiale dovrà essere recapitato al nostro reparto in porto franco: dopo accertamenti si provvederà alla sostituzione della merce o accredito. Nel caso di reso di materiale non difettoso non autorizzato saranno addebitati i costi di gestione pari al 25% del prezzo esposto in fattura all'atto dell'acquisto. Saranno accreditati solo i prodotti integri e con imballo originale, mentre gli articoli che non rispettano tali requisiti saranno rispediti al mittente. Non si accettano prodotti fuori dal listino in vigore.

GARANZIA

La garanzia sugli apparecchi è di 24 mesi, con decorrenza dalla data di consegna, per i difetti da attribuire alla fabbricazione. Sono esclusi dalla garanzia tutti i guasti causati da un uso improprio degli apparecchi e nel caso di manomissione dell'apparecchio da parte di terzi non autorizzati per iscritto dalla DESIGN LUCE SRLU. In nessun caso la DESIGN LUCE SRLU risarcirà i danni richiesti per la rimessa in opera del prodotto.

PAGAMENTI

I pagamenti dovranno pervenire presso la nostra sede o mediante personale da noi espressamente autorizzato secondo le modalità specificate in fase di registrazione del cliente presso la nostra banca dati. Il mancato pagamento autorizza la DESIGN LUCE SRLU a sospendere le forniture e saranno addebitati gli interessi di mora sullo scoperto. Per tutto quanto non citato nelle condizioni generali di compravendita sopra elencate, saranno applicate le norme sul contratto di compravendita con riferimento al Codice Civile della Repubblica Italiana. Per ogni controversia è competente il Foro di Firenze.

terms of sale

The client accepts, without exception, all the conditions of sale indicated below in the act in which he places the order, even if not explicitly declared.

This publication cancels and replaces all previous ones.

DESIGN LUCE SRLU reserves the right to cancel or make any modifications to its appliances and accessories that it deems necessary for technical and commercial or aesthetic purposes without giving prior notice. The descriptions and dimensions of the appliances shown in the catalogs and price lists are indicative and not binding.

ORDERS - CONFIRMATIONS - TRANSPORT

Orders must be sent in writing by the customer or by representatives regularly appointed by DESIGN LUCE SRLU. Telephone orders must be confirmed in writing, on headed paper, to be sent to the appropriate email address.

DESIGN LUCE SRLU reserves the right to request an advance on the total payment of the supply. For amounts over € 500.00 shipping costs will not be charged. For orders less than € 500.00 delivery will be made carriage paid with a charge of € 16.00. For items with dimensions greater than 2.00m additional € 10.00 will be charged.

For items requiring special wooden packaging there will be a minimum charge of € 15.00 which will be communicated in order confirmation.

Delivery terms will be purely indicative. The customer must provide the necessary data and have fulfilled all the obligations towards the supplier, none excluded to allow DESIGN LUCE SRLU to activate the internal procedures and issue the order confirmation with the presumed date of departure of the goods from the factories. DESIGN LUCE SRLU does not accept in any way and on behalf of anyone orders with mandatory delivery. Delays in deliveries do not entitle the customer to any compensation or grant partial or total right to cancel, terminate, terminate the purchase contract. The goods always travel at the risk and peril of the customer, regardless of the conditions of return. DESIGN LUCE SRLU will not compensate the customer for damaged, stolen or tampered with material during transport.

The customer is required to check the quantity and quality of the goods upon delivery and is required to always accept with RESERVE. The prices indicated in this price list are for the public EXCLUDING VAT and may be changed

at any time by DESIGN LUCE SRLU which will confirm the prices indicated on the order by order confirmation sent to the customer.

RETURNS OF MATERIAL

Returns of the material, including those for defective goods under warranty, must be agreed in advance in writing with DESIGN LUCE SRLU which will not accept material without authorization. This will be rejected by our department. The material must be delivered free of charge to our department: after inspections, the goods or credit will be replaced. In the case of unauthorized return of non-defective material, management costs equal to 25% of the price shown on the invoice at the time of purchase will be charged. Only intact products with original packaging will be credited, while items that do not meet these requirements will be sent back to the sender. Products outside the current price list are not accepted.

WARRANTY

The guarantee on the devices is 24 months, starting from the delivery date, for defects to be attributed to the manufacture. All faults caused by improper use of the appliances and in the case of tampering with the appliance by third parties not authorized in writing by DESIGN LUCE SRLU are excluded from the warranty. In no case the DESIGN LUCE SRLU will compensate the damages required for the re-installation of the product.

PAYMENTS

Payments must be received at our office or by personnel expressly authorized by us in the manner specified when registering the customer with our database. Failure to pay authorizes DESIGN LUCE SRLU to suspend supplies and interest for late payment will be charged. For everything not mentioned in the general conditions of sale listed above, the rules on the sale contract will be applied with reference to the Italian Civil Code. The Court of Florence is competent for any controversy.

energy labels

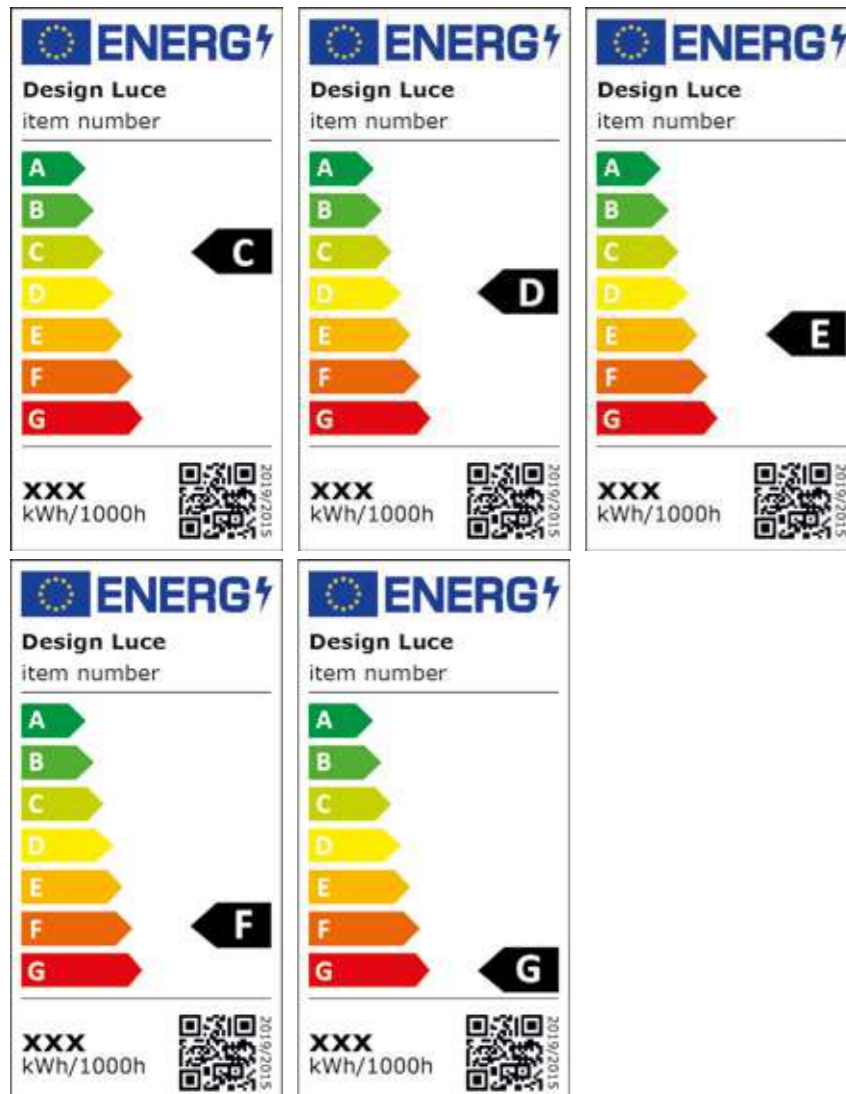
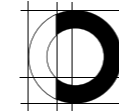

PUBLISHER

Design Luce

PROJECT COORDINATOR

Luigi Cerbone

DIGITAL IMAGING AND PAGING

Gianmarco Caroti - Junior Light Designer (Design Luce)

PHOTO

MS09 Casa privata Thiene

CH012, LC014, S21 Palazzi Centro Storico Torino

SC015 Casa privata Firenze

Kepler Casa privata Firenze

Structurae Palazzo Storico Firenze

STUDIO

C+ Partners Breganze (VI)

Negozi Blu Architetti Associati Torino

Mimesi62 - Firenze

Light Company - Firenze

EDITION

Ottobre 2024 © all right reserved

DESIGN LUCE S.r.l.u. non si assume la responsabilità per errori di stampa, dimensioni e dati tecnici. La società si riserva il diritto di apportare modifiche sui prodotti illustrati in qualsiasi momento, senza preavviso. Sono vietate riproduzioni o copie senza autorizzazione.

DESIGN LUCE S.r.l.u. via Bruno Storti 9/11, Sesto Fiorentino, Firenze

(Italy) +39 055 7223975 | info@designluce.com | www.designluce.com

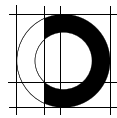

DESIGN
LUCE

DESIGN LUCE

S.r.l.u via Bruno Storti 5/9/11, Sesto Fiorentino, Firenze (Italy)
+39. 055 7223975 | info@designluce.com | www.designluce.com |